

User's Guide

NBG7510

Dual-Band WiFi 6 AX1800 Router

Default Login Details

LAN IP Address Standard (Router) Mode	http://192.168.123.1
AP Mode	http://192.168.123.2 OR http://DHCP-assigned IP
Password	See the Zyxel Device label

Version 1.0 Ed 4, 12/2022

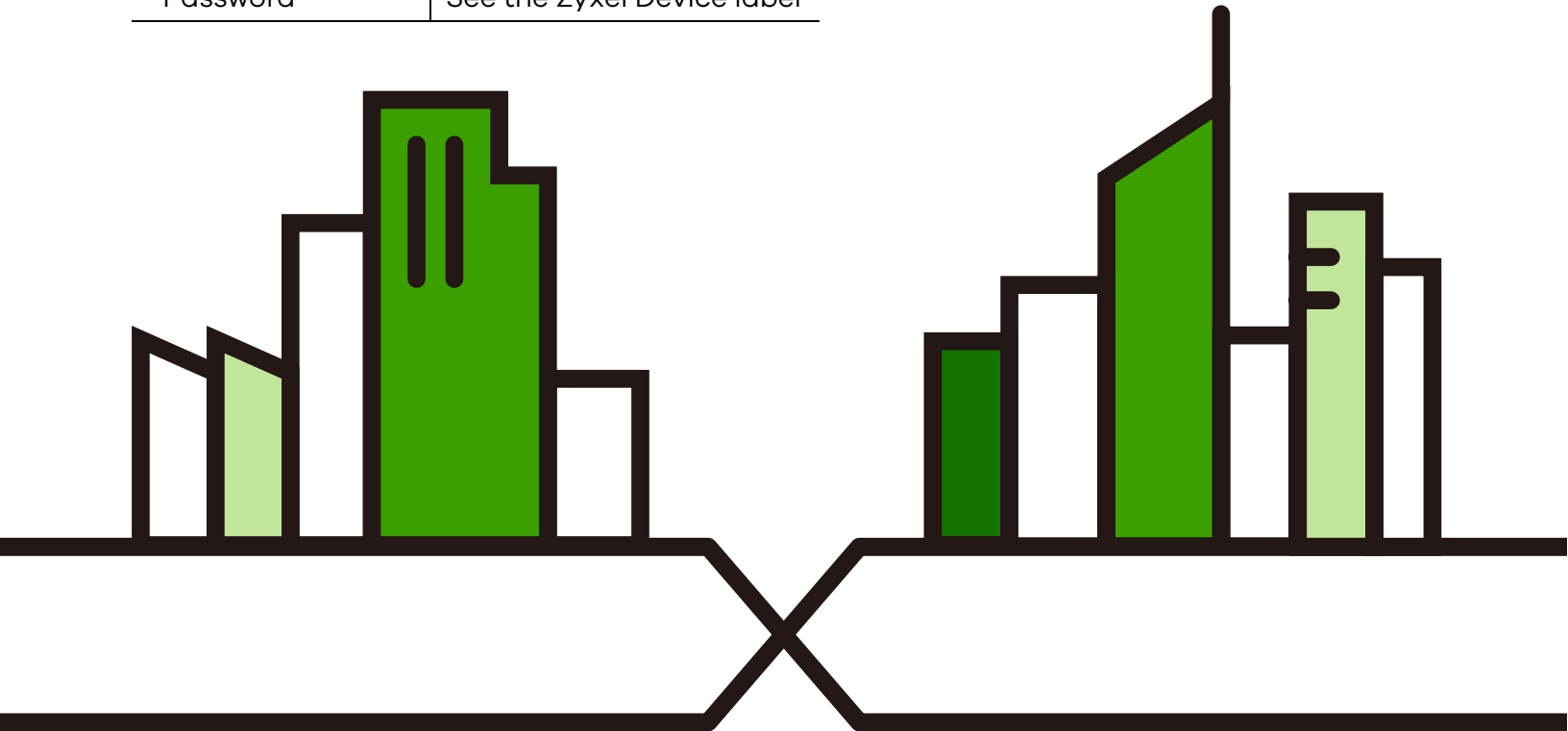

IMPORTANT!

READ CAREFULLY BEFORE USE.

KEEP THIS GUIDE FOR FUTURE REFERENCE.

Screenshots and graphics in this book may differ slightly from what you see due to differences in your product firmware or your computer operating system. Every effort has been made to ensure that the information in this manual is accurate.

Related Documentation

- Quick Start Guide
The Quick Start Guide shows how to connect the Zyxel Device.
- More Information
- Go to support.zyxel.com to find other information on the Zyxel Device.



Document Conventions

Warnings and Notes

These are how warnings and notes are shown in this guide.

Warnings tell you about things that could harm you or your Zyxel Device.









Note: Notes tell you other important information (for example, other things you may need to configure or helpful tips) or recommendations.

Syntax Conventions

- Product labels, screen names, field labels and field choices are all in **bold** font.
- A right angle bracket (>) within a screen name denotes a mouse click. For example, **Network Setting > Routing > DNS Route** means you first click **Network Setting** in the navigation panel, then the **Routing** submenu, and then finally the **DNS Route** tab to get to that screen.

Icons Used in Figures

Figures in this user guide may use the following generic icons. The Zyxel Device icon is not an exact representation of your Zyxel Device.

Zyxel Device 	Generic Router 	Switch 
Server 	Firewall 	USB Storage Device 
Printer 	4G LTE/5G NR Base Station 	

Contents Overview

User's Guide	14
Introducing the Zyxel Device	15
Hardware	25
Web Configurator	31
Quick Start	40
Web Interface Tutorials	44
Rover App Tutorials	73
Technical Reference	93
Connection Status	94
Broadband	106
Wireless	118
Home Networking	144
Routing	167
Network Address Translation (NAT)	176
DNS	193
Firewall	197
MAC Filter	208
Scheduler Rule	210
Log	212
Traffic Status	215
ARP Table	219
Routing Table	221
WLAN Station Status	224
Operating Mode	226
System	227
User Account	228
Remote Management	230
Time Settings	234
Email Notification	237
Log Setting	240
Firmware Upgrade	244
Backup/Restore	247
Diagnostic	251
Troubleshooting and Appendices	253
Troubleshooting	254

Table of Contents

Document Conventions	3
Contents Overview	4
Table of Contents	5
Part I: User's Guide.....	14
Chapter 1	
Introducing the Zyxel Device	15
1.1 Overview	15
1.2 Applications for the Zyxel Device	16
1.3 Mesh	18
1.3.1 Network Controller	18
1.3.2 Dual-Band WiFi	19
1.3.3 AP Steering	20
1.3.4 Band Steering	21
1.3.5 Daisy Chain	21
1.4 Operating Modes for the Zyxel Device	22
1.4.1 Standard (Router) Mode	22
1.4.2 AP (Bridge) Mode	23
1.5 Ways to Manage the Zyxel Device	23
1.6 Good Habits for Managing the Zyxel Device	24
Chapter 2	
Hardware	25
2.1 LED	25
2.2 Ports and Buttons	27
2.3 How to Reset the Zyxel Device	28
2.4 How to Enable WiFi/WPS	28
2.5 Wall Mounting	28
Chapter 3	
Web Configurator.....	31
3.1 Overview	31
3.1.1 Access the Web Configurator	31
3.2 Web Configurator Layout	33
3.2.1 Settings Icon	33

3.2.2 Widget Icon	38
Chapter 4	
Quick Start	40
4.1 Quick Start Overview	40
4.2 Quick Start Setup	40
4.3 Quick Start Setup – Time Zone	40
4.4 Quick Start Setup – Internet Connection	41
4.4.1 Successful Internet Connection	41
4.4.2 Unsuccessful Internet Connection	42
4.5 Quick Start Setup – WiFi	42
4.6 Quick Start Setup – Finish	43
Chapter 5	
Web Interface Tutorials.....	44
5.1 Web Interface Overview	44
5.2 Wired Network Setup	44
5.2.1 Setting Up an Ethernet Connection	44
5.3 WiFi Network Setup	47
5.3.1 Changing Security on a WiFi Network	47
5.3.2 Connecting to the Zyxel Device's WiFi Network Using WPS	50
5.3.3 Setting Up a Guest Network	53
5.3.4 Setting Up Two Guest WiFi Networks on Different WiFi Bands	57
5.4 Network Security	62
5.4.1 Configuring a Firewall Rule	62
5.4.2 Parental Control	64
5.4.3 Configuring a MAC Address Filter for Wired LAN Connections	69
5.5 Device Maintenance	70
5.5.1 Backing up the Device Configuration	70
5.5.2 Restoring the Device Configuration	71
Chapter 6	
Rover App Tutorials.....	73
6.1 Rover App Tutorials Overview	73
6.2 What You Can Do	73
6.3 WiFi Network Scenario	73
6.3.1 Connect the Rover Router to the WRE6605 Repeater	74
6.4 Wired Network Scenarios	75
6.4.1 Scenario 1: Connect your Rover AP to the Rover Router	75
6.4.2 Scenario 2: Connect the Rover Router to the WRE6605 AP	76
6.5 Network Management with the Rover App	78
6.6 Home Settings	78
6.7 General WiFi and Guest Settings	79

6.7.1 Setting Up General WiFi Settings 80
 6.7.2 Setting Up Guest WiFi Settings 83
 6.8 Devices Settings 85
 6.9 Parental Control Settings 88
 6.10 Others Settings 90

Part II: Technical Reference..... 93

**Chapter 7
 Connection Status..... 94**

7.1 Connection Status Overview 94
 7.1.1 Connectivity 94
 7.1.2 Icon and Device Name 94
 7.1.3 System Info 95
 7.1.4 WiFi Settings 97
 7.2 Guest WiFi Settings 99
 7.2.1 LAN 101
 7.3 The Parental Control Screen 102
 7.3.1 Create a Parental Control Profile 103
 7.3.2 Define a Schedule 104

**Chapter 8
 Broadband..... 106**

8.1 Broadband Overview 106
 8.1.1 What You Can Do in this Chapter 106
 8.1.2 What You Need to Know 107
 8.1.3 Before You Begin 109
 8.2 Broadband Settings 109
 8.2.1 Edit Internet Connection 110
 8.3 Technical Reference 115

**Chapter 9
 Wireless 118**

9.1 Wireless Overview 118
 9.1.1 What You Can Do in this Chapter 118
 9.1.2 What You Need to Know 118
 9.2 Wireless General Settings 119
 9.2.1 No Security 122
 9.2.2 More Secure (Recommended) 122
 9.3 Guest/More AP Screen 123
 9.3.1 The Edit Guest/More AP Screen 124

9.4 MAC Authentication	127
9.5 WPS	128
9.6 WMM	129
9.7 Others Screen	130
9.8 Channel Status	133
9.9 Mesh	133
9.10 Mesh Topology	134
9.11 Technical Reference	135
9.11.1 WiFi Network Overview	135
9.11.2 Additional WiFi Terms	136
9.11.3 WiFi Security Overview	136
9.11.4 Signal Problems	138
9.11.5 BSS	138
9.11.6 MBSSID	139
9.11.7 Preamble Type	139
9.11.8 WiFi Protected Setup (WPS)	140
Chapter 10	
Home Networking.....	144
10.1 Home Networking Overview	144
10.1.1 What You Can Do in this Chapter	144
10.1.2 What You Need To Know	144
10.1.3 Before You Begin	146
10.2 LAN Setup	146
10.3 Static DHCP	150
10.3.1 Before You Begin	150
10.4 UPnP	152
10.5 LAN Additional Subnet	153
10.6 Wake on LAN	155
10.7 TFTP Server Name	156
10.8 Technical Reference	157
10.8.1 DHCP Setup	157
10.8.2 DNS Server Addresses	157
10.8.3 LAN TCP/IP	158
10.9 Turn on UPnP in Windows 10 Example	159
10.9.1 Auto-discover Your UPnP-enabled Network Device	161
10.10 Web Configurator Easy Access in Windows 10	164
Chapter 11	
Routing.....	167
11.1 Routing Overview	167
11.2 Configure Static Route	167
11.2.1 Add or Edit Static Route	168

11.3 DNS Route	172
11.3.1 Add or Edit DNS Route	173
11.4 Policy Route	173
11.4.1 Add or Edit Policy Route	174
Chapter 12	
Network Address Translation (NAT)	176
12.1 NAT Overview	176
12.1.1 What You Can Do in this Chapter	176
12.1.2 What You Need To Know	176
12.2 Port Forwarding	177
12.2.1 Port Forwarding	178
12.2.2 Add or Edit Port Forwarding	178
12.3 Port Triggering	180
12.3.1 Add or Edit Port Triggering Rule	182
12.4 DMZ	183
12.5 ALG	184
12.6 Address Mapping	185
12.6.1 Address Mapping Screen	185
12.6.2 Add New Rule Screen	186
12.7 Sessions	188
12.8 Technical Reference	188
12.8.1 NAT Definitions	189
12.8.2 What NAT Does	189
12.8.3 How NAT Works	190
12.8.4 NAT Application	190
Chapter 13	
DNS	193
13.1 DNS Overview	193
13.1.1 What You Can Do in this Chapter	193
13.1.2 What You Need To Know	194
13.2 DNS Entry	194
13.2.1 Add or Edit DNS Entry	195
13.3 Dynamic DNS	195
Chapter 14	
Firewall	197
14.1 Firewall Overview	197
14.1.1 What You Need to Know About Firewall	197
14.2 Firewall	198
14.2.1 What You Can Do in this Chapter	199
14.3 Firewall General Settings	199

14.4 Protocol (Customized Services)	200
14.4.1 Add Customized Service	201
14.5 Access Control (Rules)	201
14.5.1 Add New ACL Rule	202
14.6 DoS	204
14.7 Firewall Technical Reference	205
14.7.1 Firewall Rules Overview	205
14.7.2 Guidelines For Security Enhancement With Your Firewall	206
14.7.3 Security Considerations	206
Chapter 15	
MAC Filter	208
15.1 MAC Filter Overview	208
15.2 MAC Filter	208
15.2.1 Add New Rule	209
Chapter 16	
Scheduler Rule	210
16.1 Scheduler Rule Overview	210
16.2 Scheduler Rule Settings	210
16.2.1 Add or Edit a Schedule Rule	211
Chapter 17	
Log	212
17.1 Log Overview	212
17.1.1 What You Can Do in this Chapter	212
17.1.2 What You Need To Know	212
17.2 System Log	213
17.3 Security Log	214
Chapter 18	
Traffic Status	215
18.1 Traffic Status Overview	215
18.1.1 What You Can Do in this Chapter	215
18.2 WAN Status	215
18.3 LAN Status	217
18.4 NAT Status	218
Chapter 19	
ARP Table	219
19.1 ARP Table Overview	219
19.1.1 How ARP Works	219
19.2 ARP Table	219

Chapter 20	
Routing Table	221
20.1 Routing Table Overview	221
20.2 Routing Table	221
Chapter 21	
WLAN Station Status	224
21.1 WLAN Station Status Overview	224
Chapter 22	
Operating Mode	226
22.1 Operating Mode Overview	226
Chapter 23	
System	227
23.1 System Overview	227
23.2 System	227
Chapter 24	
User Account	228
24.1 User Account Overview	228
24.2 User Account	228
Chapter 25	
Remote Management	230
25.1 Remote Management Overview	230
25.1.1 What You Can Do in this Chapter	230
25.2 MGMT Services	230
25.3 Trust Domain	232
25.4 Add Trust Domain	232
Chapter 26	
Time Settings	234
26.1 Time Settings Overview	234
26.2 Time	234
Chapter 27	
Email Notification	237
27.1 Email Notification Overview	237
27.2 Email Notification	237
27.2.1 E-mail Notification Edit	238

Chapter 28	
Log Setting	240
28.1 Log Setting Overview	240
28.2 Log Setting	240
28.2.1 Example Email Log	242
Chapter 29	
Firmware Upgrade	244
29.1 Firmware Upgrade Overview	244
29.2 Firmware Upgrade	244
29.3 Module Upgrade	245
Chapter 30	
Backup/Restore	247
30.1 Backup/Restore Overview	247
30.2 Backup/Restore	247
30.3 Reboot	250
Chapter 31	
Diagnostic	251
31.1 Diagnostic Overview	251
31.1.1 What You Can Do in this Chapter	251
31.2 Diagnostic	251
Part III: Troubleshooting and Appendices	253
Chapter 32	
Troubleshooting	254
32.1 Troubleshooting Overview	254
32.2 Power and Hardware Problems	254
32.3 Device Access Problems	255
32.4 Internet Problems	258
32.5 WiFi Problems	259
32.6 UPnP Problems	260
32.7 Getting More Troubleshooting Help	260
Appendix A Customer Support	261
Appendix B IPv6.....	266
Appendix C Services.....	272
Appendix D Legal Information	276

[Index](#)282

PART I

User's Guide

CHAPTER 1

Introducing the Zyxel Device

1.1 Overview

This chapter introduces the main features and applications of the Zyxel Device. The Zyxel Device is an Ethernet router, which provides fast Internet access.

The Zyxel Device supports WiFi6 that is most suitable in areas with a high concentration of users. You can schedule WiFi usage using Parental Control.

This table summarizes some of the features that are available at the time of writing.

Table 1 Features Supported

FEATURE	NBG7510
WiFi6 Standard	YES
2.4 GHz WLAN	YES
5 GHz WLAN	YES
Parental Control Schedule	YES
Parental Control URL Filter	NO
Rubber feet for desktop placement	NO
Wall-mount	YES
Operating mode	YES
Mobile app	YES
VLAN (Virtual Local Area Network)	YES
OpenVPN	NO
Guest WiFi	YES
Firewall	YES
NAT and Port Forwarding	YES
ALG (Application Layer Gateway)	YES
VPN (Virtual Private Network) Pass-through	NO
Port Triggering	YES
Dynamic DNS (Domain Name System)	YES
IPv6 support	YES
UPnP (Universal Plug-and-Play)	YES
Speed Test	No
Save configuration	YES
Firmware Version	1.00

1.2 Applications for the Zyxel Device

The Zyxel Device supports the following features.

Internet Access

The Zyxel Device provides Internet access by connecting the WAN port to your ISP through an Ethernet cable.

Computers can connect to the Zyxel Device's LAN ports (or wirelessly) and access the Internet simultaneously.

Figure 1 The Zyxel Device's Internet Access Application

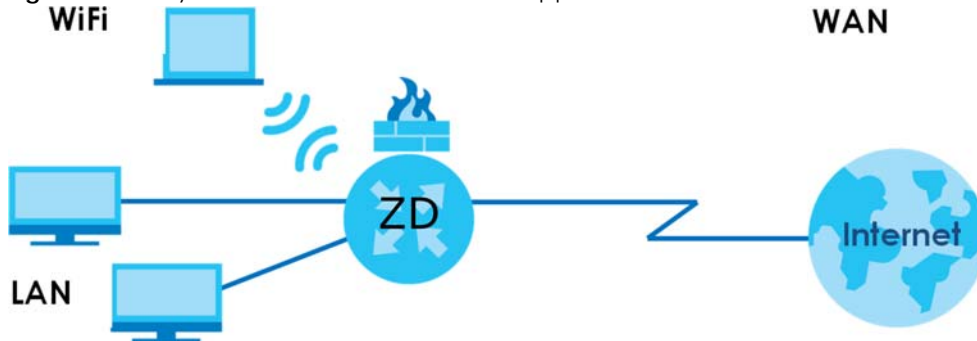

You can also configure the firewall on the Zyxel Device for secure Internet access. When the firewall is on, all incoming traffic from the Internet to your network is blocked by default unless it is initiated from your network. This means that probes from the outside to your network are not allowed, but you can safely browse the Internet and download files.

Connect the WAN port to the broadband modem or router. This way, you can access the Internet through an Ethernet connection and use the firewall and parental control functions on the Zyxel Device.

Figure 2 The Zyxel Device's Internet Access Application: Ethernet WAN

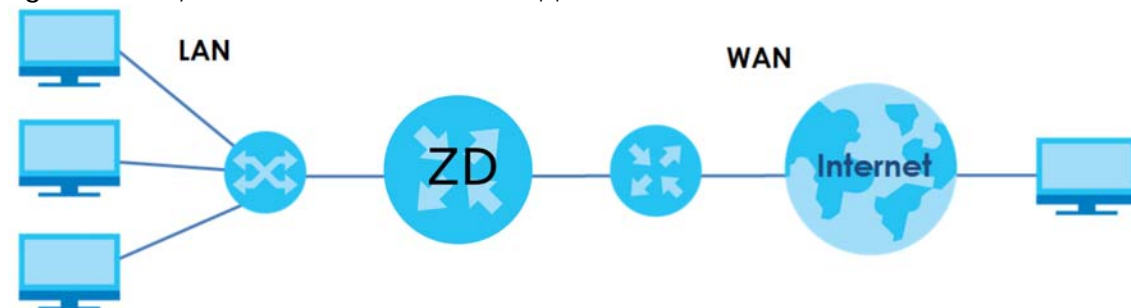

Dual-Band WiFi

IEEE 802.11a/b/g/n/ac/ax compliant clients can wirelessly connect to the Zyxel Device to access network resources.

The Zyxel Device is a dual-band gateway that can use both 2.4 GHz and 5 GHz networks at the same time. You could use the 2.4 GHz band for regular Internet surfing and downloading while using the 5 GHz

band for time sensitive traffic like high-definition video, music, and gaming.

Figure 3 Dual-Band Application

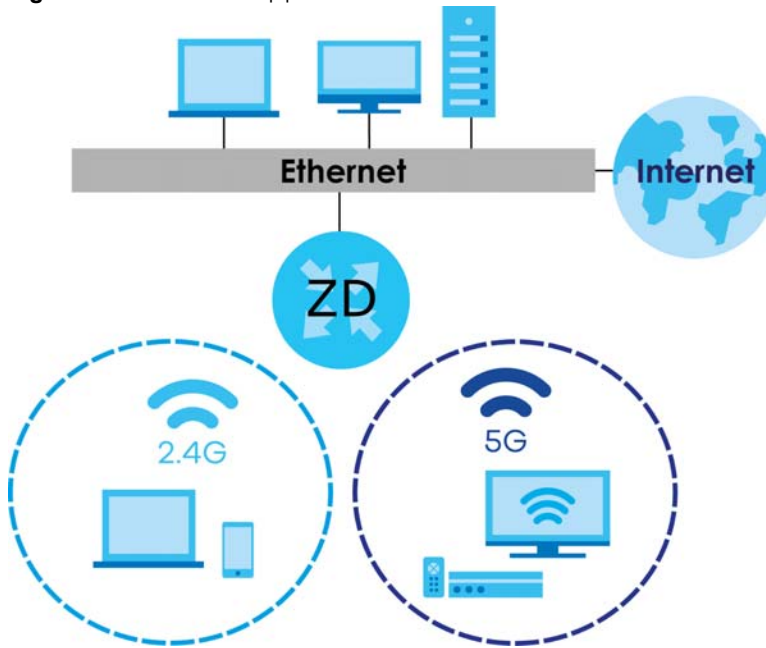

The Zyxel Device is a WiFi Access Point (AP) for IEEE 802.11b/g/n/a/ac/ax WiFi clients, such as notebook computers, tablets, smartphones, and so on. It allows them to connect to the Internet without having to rely on inconvenient Ethernet cables.

The Zyxel Device supports WiFi Protected Setup (WPS), which allows you to quickly set up a WiFi network with strong security. You can use WPS (WiFi Protected Setup) to create an instant WiFi network connection with another WPS-compatible device.

Figure 4 WiFi Access Example

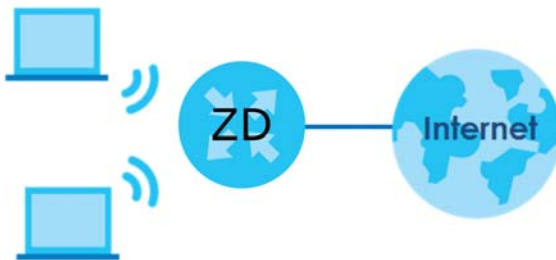

Guest WiFi

The Zyxel Device allows you to set up a guest WiFi network where users can access the Internet through the Zyxel Device, but not to other networks connected to it.

IPv6 and IPv6 Firewall

IPv6 (Internet Protocol version 6), is designed to enhance IP address size and features. The increase in IPv6 address size to 128 bits (from the 32-bit IPv4 address) allows up to 3.4×10^{38} IP addresses. The Zyxel Device can use IPv4/IPv6 dual stack to connect to IPv4 and IPv6 networks, and support IPv6 rapid deployment (6RD).

Consequently, you can enable and create IPv6 firewall rules to filter IPv6 traffic.

Firewall protects your Zyxel Device and network from attacks by hackers on the Internet and control access to it. The firewall:

- allows traffic that originates from your LAN computers to go to all other networks
- blocks traffic that originates on other networks from going to the LAN

The following figure illustrates the firewall action. User A can initiate an IM (Instant Messaging) session from the LAN to the WAN (1). Return traffic for this session is also allowed (2). However other traffic initiated from the WAN is blocked (3 and 4).

Figure 5 Firewall Default Action

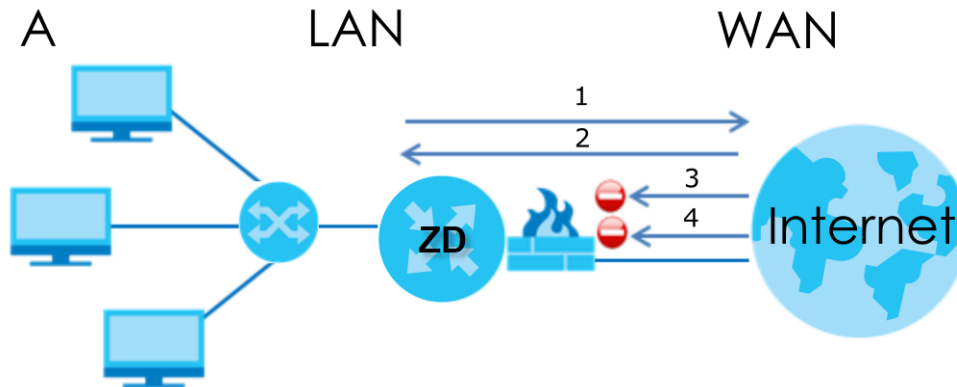

1.3 Mesh

An Mesh network is composed of three key components.

- A router works as a controller to manage and optimize the Mesh network.
- One or more devices in the Mesh network function as APs or WiFi Extenders to extend the WiFi communication range.
- Multiple client devices connect to the Mesh network for Internet connections.

1.3.1 Network Controller

The Mesh Router is the Network Controller and the Extender is also known as a Satellite.

The Zyxel Device functions as a controller to coordinate and optimize WiFi activity in the Mesh network. The controller collects Channel Availability Check responses and scan reports from the APs or WiFi Extenders. Then, the controller selects the best channel and the final optimized topology based on the current situation.

The Mesh network uses AP steering and Band steering mechanisms to improve WiFi performance. AP steering allows WiFi clients to roam seamlessly in a Mesh network. Band steering allows 2.4 GHz / 5 GHz dual-band WiFi clients to move from one band to another less busy band. For AP steering to work, the controller and the devices in the Mesh network must use the same SSID and password. For band steering

to work, the SSIDs and passwords of 2.4GHz and 5GHz must be identical. See [Section 1.3.3 on page 20](#) and [Section 1.3.4 on page 21](#) for more information. The controller synchronizes the SSIDs and passwords during auto-configuration.

- The Zyxel Device connects to an AP using an Ethernet cable to expand the WiFi coverage.
- The Zyxel Device connects to a WiFi extender using WiFi. You can place the WiFi extender between the Zyxel Device and the WiFi clients who require WiFi but are not in the coverage of the Zyxel Device.

Figure 6 Mesh Application

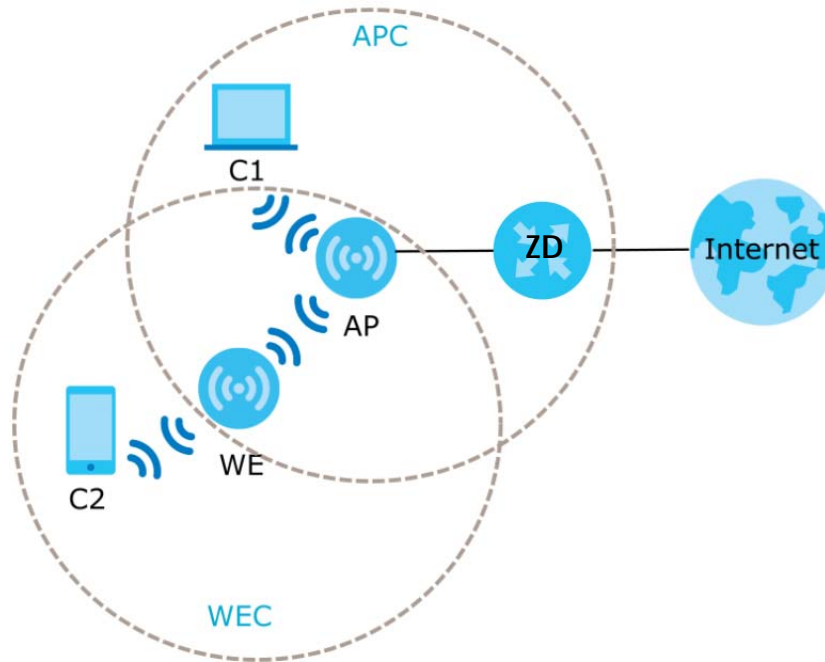

The following table describes the icons used in the figure.

Table 2 Mesh Application

LABEL	DESCRIPTION
ZD	Router Controller
AP	Access Point
WE	WiFi Extender
C1	Client1
C2	Client2
APC	Access Point coverage area
WEC	WiFi Extender coverage area

1.3.2 Dual-Band WiFi

The Zyxel Device is a dual-band device that can use both 2.4 GHz and 5 GHz at the same time. IEEE 802.11a/b/g/n/ac/ax compliant clients can wirelessly connect to the Zyxel Device to access network resources. You could use the 2.4 GHz band for regular Internet surfing and downloading while using the 5 GHz band for time sensitive traffic like high-definition video, music, and gaming.

Figure 7 Dual-Band Application

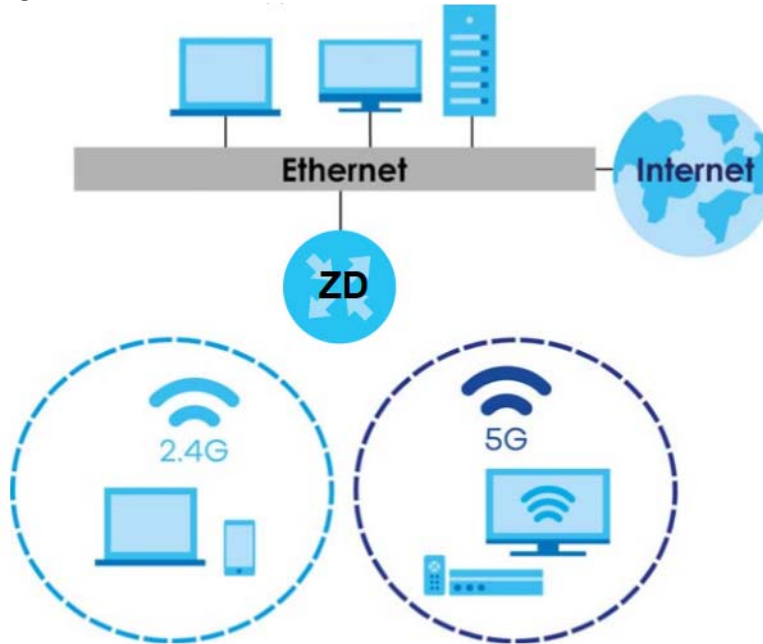

1.3.3 AP Steering

AP steering allows WiFi clients to roam seamlessly in the Mesh network. AP steering helps monitor WiFi clients and drops their connections to optimize the Zyxel Device bandwidth when the clients are idle or have a low signal. When a WiFi client is dropped, it has the opportunity to reconnect to an AP or WiFi Extender with a stronger signal.

In the following example, the controller (ZD) drops the connection between the client device (C) and the WiFi Extender (WE) so that the client device (C) can connect to the Access Point (AP), which has a stronger signal.

Figure 8 AP Steering Application

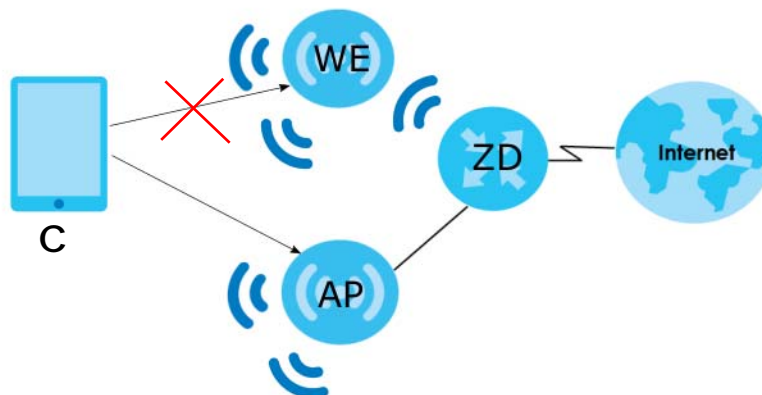

1.3.4 Band Steering

Band steering allows 2.4 GHz/5 GHz dual-band WiFi clients to move from one band to another. The controller detects if the client device are dual-band compatible. If a client device supports dual-band WiFi and the 2.4 GHz band is congested, its 2.4 GHz connection is dropped so that it can connect to the less congested 5 GHz band.

In the following example, the Apple TV is a dual-band client device that uses the 5 GHz band.

Figure 9 Band Steering Application

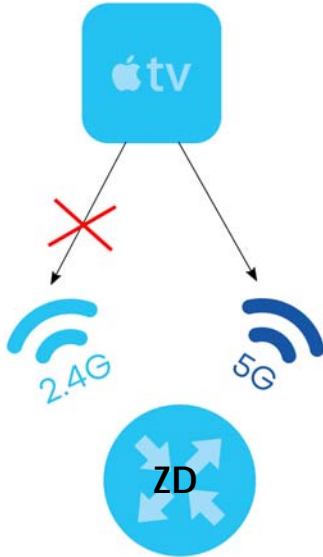

1.3.5 Daisy Chain

You can add more APs or WiFi Extenders to your Mesh network to form a daisy chain. Daisy chain refers to the connection from the Zyxel Device to up to three APs or WiFi Extenders to extend the WiFi connection from the router to the client.

- If the Zyxel Device has a wired downlink connection, the device connected to the Zyxel Device must be an AP.
- If the Zyxel Device has a WiFi downlink connection, the device connected to the Zyxel Device must be a WiFi Extender.

Here are some example scenarios of the Zyxel Device's daisy chain connection:

Figure 10 Scenario 1: Three APs

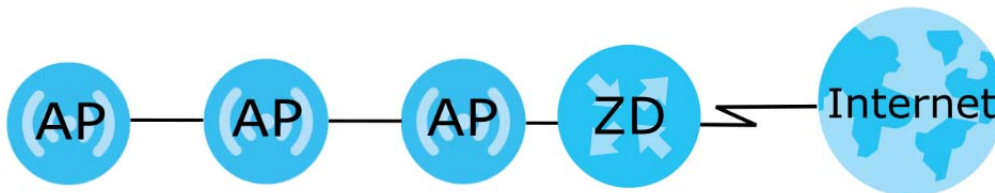

Figure 11 Scenario 2: Two APs and one WE

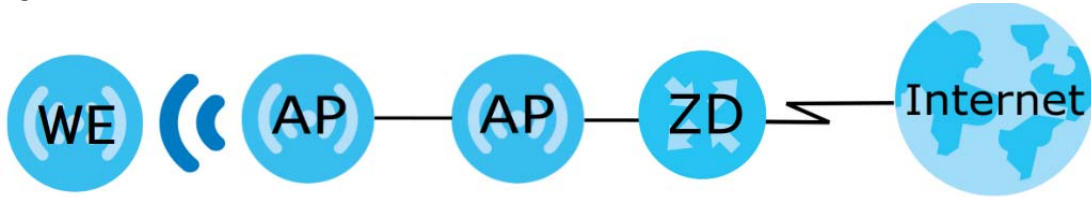

Figure 12 Scenario 3: One AP and two WEs

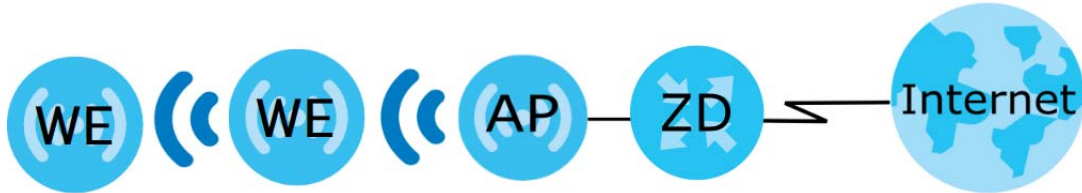

Figure 13 Scenario 4: Two WEs



Note: We do not recommend connecting more than three APs or WiFi Extenders in your daisy chain network.

Note: If one of the WiFi Extenders has a WiFi uplink connection, we do not recommend linking the other WiFi Extenders in your daisy chain network with a wired connection.

Figure 14 Not Recommended Connection Example

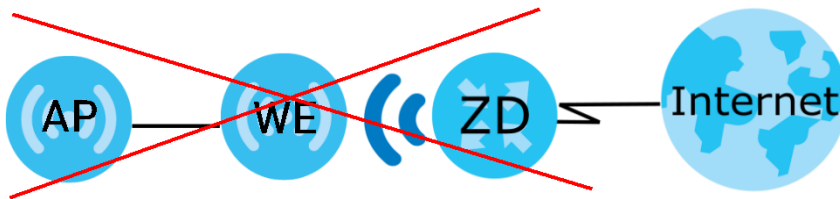

1.4 Operating Modes for the Zyxel Device

The Zyxel Device is available in both Standard (router) mode and AP (bridge) mode.

1.4.1 Standard (Router) Mode

The Zyxel Device is set to standard (router) mode by default. The Zyxel Device is used to connect the local network to another network (for example, the Internet). In standard mode Zyxel Device has two IP addresses, a LAN IP address and a WAN IP address. It also has more routing features. In the example scenario below, Zyxel Device connects the local network to the Internet through a modem (M).

Figure 15 Standard Mode Example

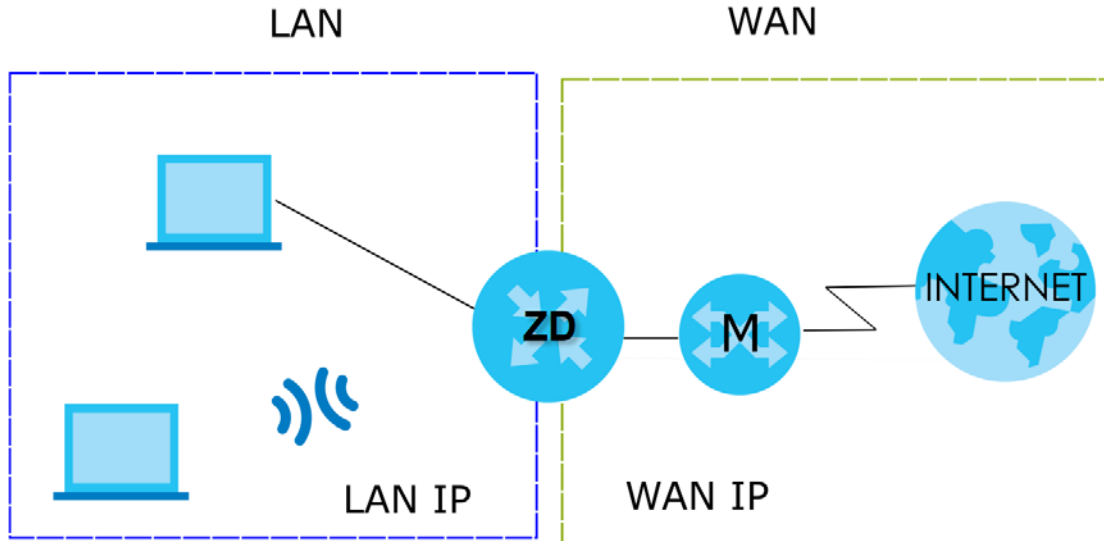

1.4.2 AP (Bridge) Mode

Use your Zyxel Device as a bridge if you already have a router or gateway on your network. In this mode your Zyxel Device bridges a wired network (LAN) and WiFi in the same subnet. In AP mode, Zyxel Device has one IP address and Zyxel Device interfaces are bridged together in the same network. In the example scenario below, Zyxel Device connects the local network to the Internet through a router (R).

Figure 16 AP Mode Example

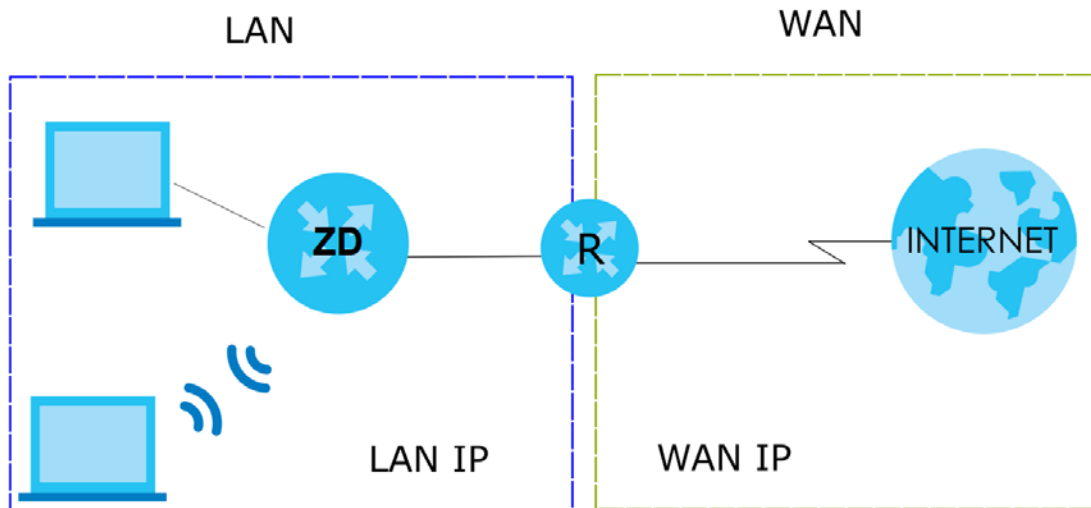

1.5 Ways to Manage the Zyxel Device

Use any of the following methods to manage the Zyxel Device.

- Web Configurator. This is recommended for management of the Zyxel Device using a supported web browser.

- Secure Shell (SSH), Telnet. Use for troubleshooting the Zyxel Device by qualified personnel.
- FTP. Use FTP for firmware upgrades and configuration backup or restore.

1.6 Good Habits for Managing the Zyxel Device

Do the following things regularly to make the Zyxel Device more secure and to manage the Zyxel Device more effectively.

- Change the WiFi and Web Configurator passwords. Use a password that is not easy to guess and that consists of different types of characters, such as numbers and letters.
- Write down the passwords and put it in a safe place.
- Back up the configuration (and make sure you know how to restore it). Restoring an earlier working configuration may be useful if the device becomes unstable or even crashes. If you forget your password, you will have to reset the Zyxel Device to its factory default settings. If you backed up an earlier configuration file, you would not have to totally re-configure the Zyxel Device. You could simply restore your last configuration.

CHAPTER 2

Hardware

This chapter describes the [LED](#) and [Ports and Buttons](#) on the Zyxel Device.

2.1 LED

After you connect the power to the Zyxel Device, view the LED to ensure proper functioning of the Zyxel Device and as an aid to troubleshooting.

Figure 17 LED



The following table describes the LED behavior on the top panel.

Table 3 LED Behavior

LED	COLOR	STATUS	DESCRIPTION
The LED Indicator	Red	Blinking	There is no Internet connection.
	Blue	On	The Internet is ready.
		Blinking	The Zyxel Device is booting up.
		Off	Power is off.
	Red/Blue	Blinking	The Zyxel Device is in the process of resetting to factory defaults.
	Purple	On	The Zyxel Device is updating firmware.
		Blinking	WPS is in progress.

2.2 Ports and Buttons

The following figure shows the ports and buttons on the Zyxel Device.

Figure 18 Ports and Buttons



The following table describes the items on the side panel of the Zyxel Device.

Table 4 Panel Ports and Buttons

LABEL	DESCRIPTION
WIFI/WPS	Press the WIFI/WPS button for 1.5 - 4 seconds to quickly setup a secure WiFi connection between the Zyxel Device and a WPS-compatible client device.
RESET	Press the button for more than 5 seconds to return the Zyxel Device to the factory defaults.
LAN1 – LAN3	Connect computers or other Ethernet devices to Ethernet LAN ports for Internet access.
WAN	For the Zyxel Device, connect an Ethernet cable to the WAN port for Internet access.
DC12V	Connect a power adapter to start the device.

2.3 How to Reset the Zyxel Device

If you forget your password or cannot access the Web Configurator, insert a thin object into the RESET hole to reload the factory-default configuration file. This means that you will lose all configurations that you had previously. The password will be reset to the factory default (see the device label), and the LAN IP address will be "192.168.123.1".

- 1 Make sure the LED lights blue (not blinking).
- 2 Locate the RESET hole.
- 3 Insert a thin object into the RESET hole for more than 5 seconds or until the LED begins to blink red and blue and then release it. The LED will blink blue when the defaults have been restored and the Zyxel Device restarts.

2.4 How to Enable WiFi/WPS

You can use the **WiFi/WPS** button to quickly set up a secure WiFi connection between the Zyxel Device and a WPS-compatible client device by adding one device at a time.

To activate WiFi/WPS:

- 1 Make sure the **POWER** LED lights blue and not blinking.
- 2 Press the **WiFi/WPS** button for 1.5-4 seconds and release it.
- 3 Press the WPS button on another WPS-enabled client device within range of the Zyxel Device within 120 seconds. The LED flashes purple while the Zyxel Device sets up a WPS connection with the client device.
- 4 Once the connection is successfully made, the LED will light up in blue.

2.5 Wall Mounting

Please refer to the installation guide below for the wall mounting procedures of the Zyxel Device. You may need screw anchors if mounting on a concrete or brick wall.

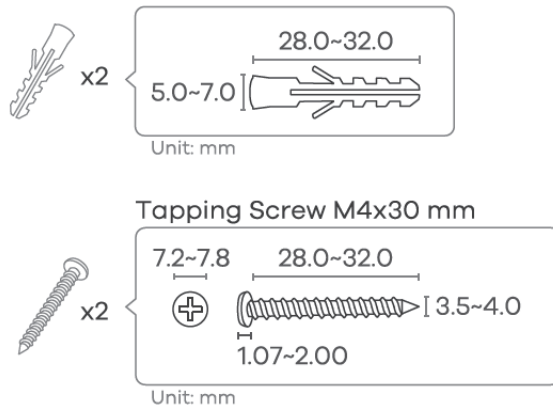
Figure 19 Wall Mounting Screw Specifications**Table 5** Wall Mounting Information

Distances between holes	105 mm
M4 Screws	Two
Screw Anchors	Two

Do the following to attach your Zyxel Device to a wall.

- 1 Select a position free of obstructions on a wall strong enough to hold the weight of the Zyxel Device.
- 2 Mark two holes on the wall at the appropriate distance apart for the screws.

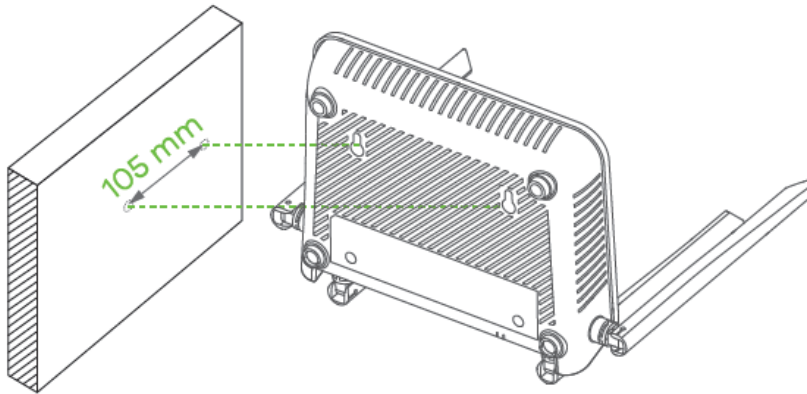
Figure 20 Wall Mounting Distance

Be careful to avoid damaging pipes or cables located inside the wall when drilling holes for the screws.

Do not wall mount the Zyxel Device over a height of 2 m.

- 3 If using screw anchors, drill two holes for the screw anchors into the wall. Push the anchors into the full depth of the holes, then insert the screws into the anchors. Do not insert the screws all the way in – leave a small gap of about 0.5 cm. If not using screw anchors, use a screwdriver to insert the screws into the wall. Do not insert the screws all the way in - leave a gap of about 0.5 cm.

Figure 21 Wall Mounting Anchors

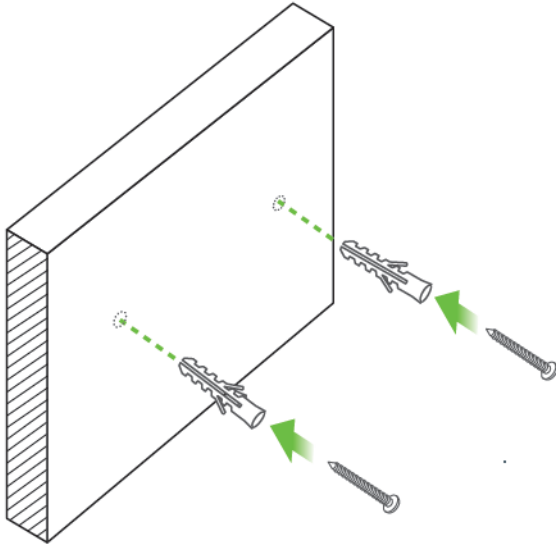

- 4 Make sure the screws are fastened well enough to hold the weight of the Zyxel Device with the connection cables.
- 5 Align the holes on the back of the Zyxel Device with the screws on the wall. Hang the Zyxel Device on the screws.

Figure 22 Wall Mounting Device

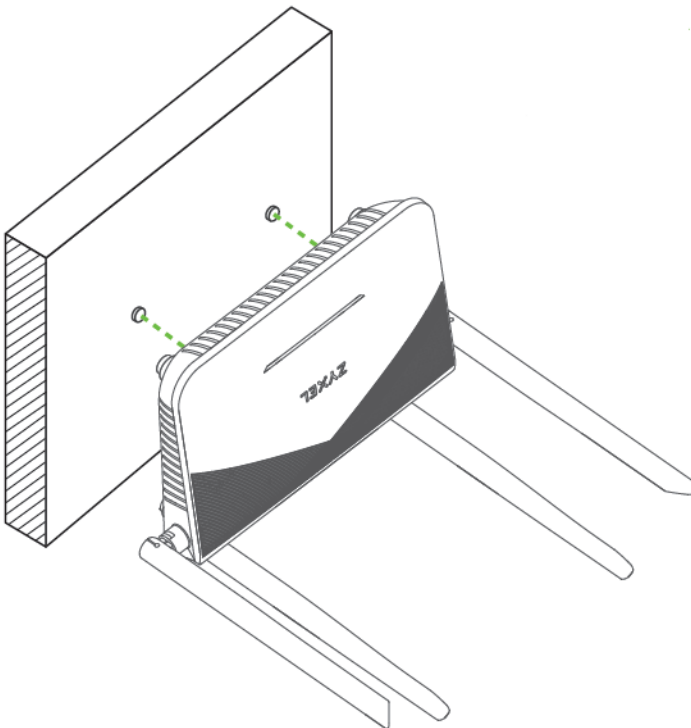

CHAPTER 3

Web Configurator

3.1 Overview

The Web Configurator is an HTML-based management interface that allows easy system setup and management through Internet browser. Use a browser that supports HTML5, such as Microsoft Edge, Mozilla Firefox, or Google Chrome. The recommended minimum screen resolution is 1024 by 768 pixels.

In order to use the Web Configurator you need to allow:

- Web browser pop-up windows from your computer.
- JavaScript (enabled by default).
- Java permissions (enabled by default).

3.1.1 Access the Web Configurator

- 1 Make sure your Zyxel Device hardware is properly connected (refer to the Quick Start Guide).
- 2 Make sure your computer has an IP address in the same subnet as the Zyxel Device.
- 3 Launch your web browser. If the Zyxel Device does not automatically re-direct you to the login screen, go to <http://192.168.123.1>.
- 4 A login screen displays. Select the language you prefer (upper right).
- 5 To access the administrative Web Configurator and manage the Zyxel Device, type the default user name **admin** and the randomly assigned default password (see the Zyxel Device label) in the **Login** screen and click **Login**. If you have changed the password, enter your password and click **Login**.

Figure 23 Login Screen

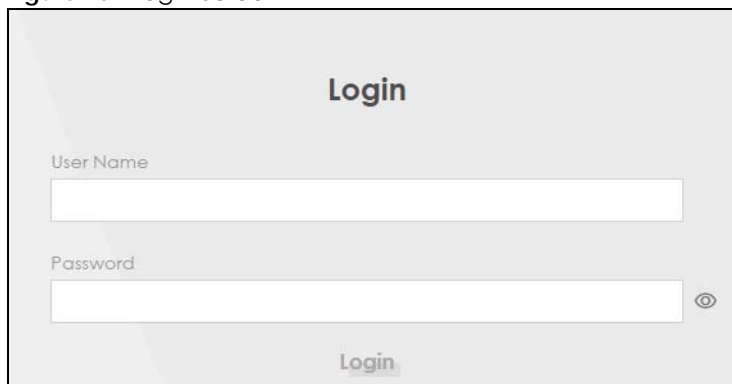

The image shows a web browser window displaying the login page of a Zyxel device. The page has a light gray background. At the top center, the word "Login" is displayed in a bold, dark font. Below this, there are two input fields. The first is labeled "User Name" and is empty. The second is labeled "Password" and is also empty, with a small eye icon to its right, indicating a password field. At the bottom center of the form area, there is a "Login" button.

Note: The first time you enter the password, you will be asked to change it. Make sure the new password must contain at least one uppercase letter, one lowercase letter and one number. For some models, the password must contain at least one English character and one number. Please see the password requirement displayed on the screen.

- 6 The **Connection Status** screen appears. Use this screen to configure basic Internet access and WiFi settings.

Figure 24 Connection Status

The screenshot displays the ZYXEL NBG7510 web configurator interface. The top header shows the ZYXEL logo and the model number NBG7510. The main content area is organized into six panels, each with a right-pointing arrow for further configuration:

- Connectivity:** Shows a flow diagram with three nodes: a globe, a router, and a laptop, all connected by lines and marked with green checkmarks.
- System Info:** Lists system details: Model Name (NBG7510), Firmware Version (V1.00(ABZY.0)b5), System Uptime (0 days 3 hours 26 minutes 20 seconds), LAN MAC Address (D4:1A:D1:27:25:80), and Ethernet WAN (100M/Full).
- WiFi Settings:** Configures 2.4G and 5G WiFi. Both bands are turned on. The 2.4G WiFi Name is 'Zyxel_2581' and the 5G WiFi Name is 'Zyxel_2581'. Both have their respective WiFi Password fields masked with dots.
- Guest WiFi Settings:** Configures 2.4G and 5G Guest WiFi. Both bands are turned off. The 2.4G Guest WiFi Name is 'Zyxel_2581_guest 1' and the 5G Guest WiFi Name is 'Zyxel_2581_guest 1'. Both have their respective WiFi Password fields masked with dots.
- LAN:** Shows network parameters: IP Address (192.168.123.1), Subnet Mask (255.255.255.0), IP Address Range (192.168.123.2 ~ 192.168.123.254), DHCP (enabled), and Lease Time (1 days 0 hours 0 minutes).
- Parental Control:** Shows a large '0' in a circle with the text 'profile scheduled' below it.

3.2 Web Configurator Layout

Figure 25 Screen Layout

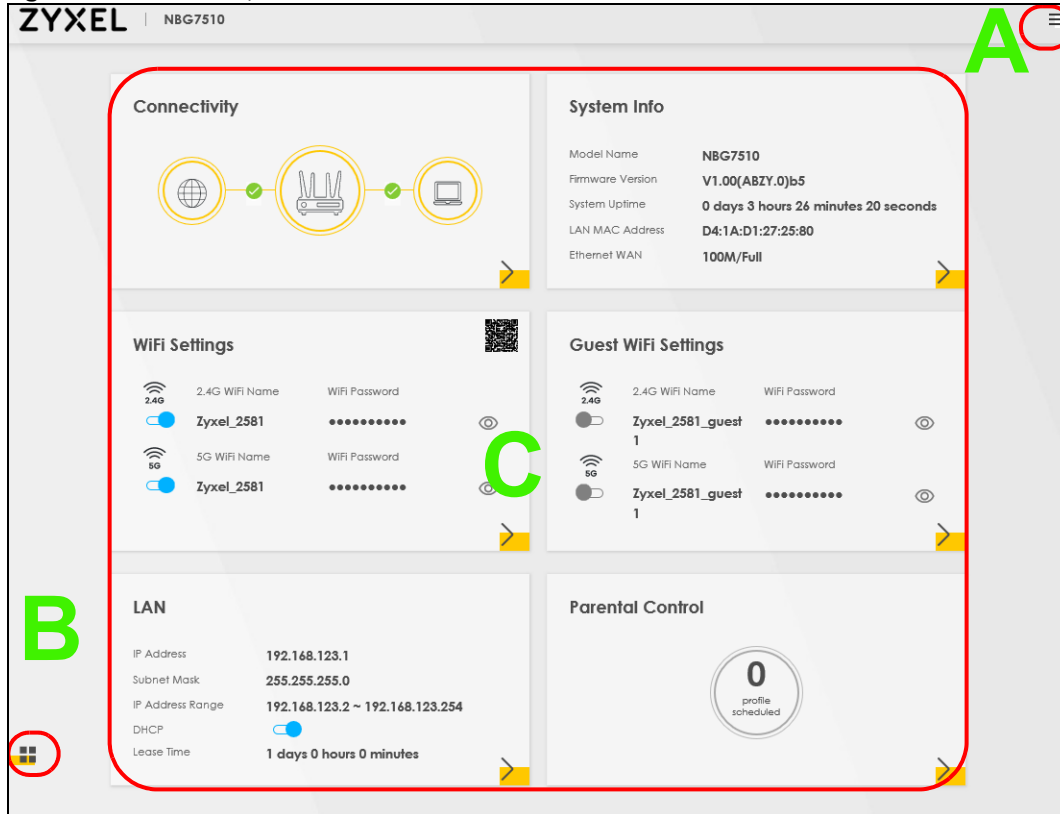

As illustrated above, the main screen is divided into these parts:

- A – Settings Icon (Navigation Panel and Side Bar)
- B – Layout Icon
- C – Main Window

3.2.1 Settings Icon

Click this icon (☰) to see the side bar and navigation panel.

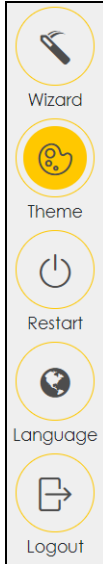

3.2.1.1 Side Bar

The side bar provides some icons on the right hand side.

Figure 26 Side Bar

The icons provide the following functions.

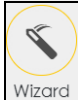
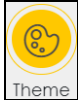
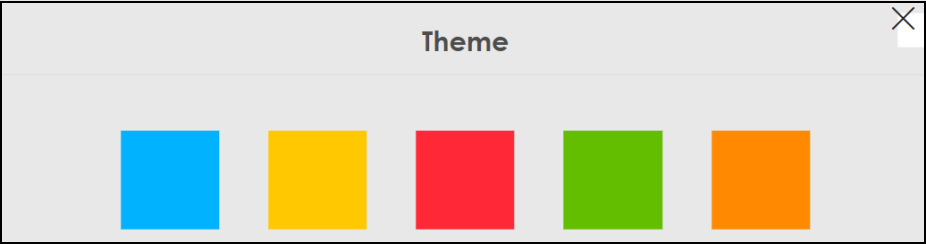
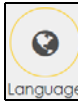
Table 6 Web Configurator Icons in the Title Bar

ICON	DESCRIPTION
 Wizard	Wizard: Click this icon to open screens where you can configure the Zyxel Device's time zone and WiFi settings.
 Theme	Theme: Click this icon to select a color that you prefer and apply it to the Web Configurator. 
 Language	Language: Select the language you prefer.
 Restart	Restart: Click this icon to reboot the Zyxel Device without turning the power off.
 Logout	Logout: Click this icon to log out of the Web Configurator.

3.2.1.2 Navigation Panel

Click the menu icon () to display the navigation panel that contains configuration menus and icons (quick links). Click **X** to close the navigation panel.

Use the menu items on the navigation panel to open screens to configure Zyxel Device features. The following tables describe each menu item.

Figure 27 Navigation Panel

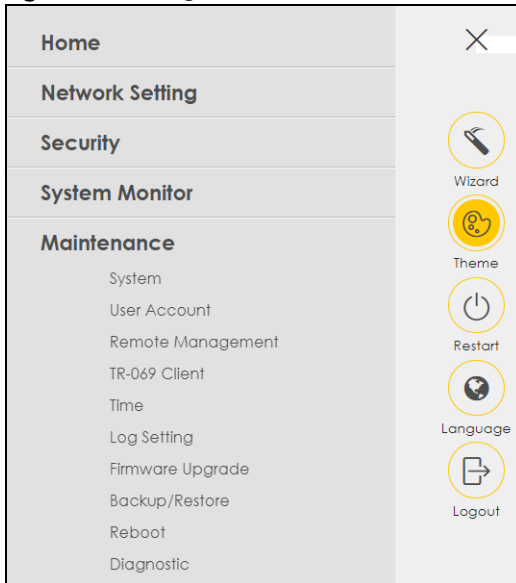

Table 7 Navigation Panel Summary

LINK	TAB	FUNCTION
Connection Status		Use this screen to configure basic Internet access, wireless settings, and parental control settings. This screen also shows the network status of the Zyxel Device and computers/devices connected to it.
Network Setting		
Broadband	Broadband	Use this screen to view and configure ISP parameters, WAN IP address assignment, and other advanced properties. You can also add new WAN connections.
Wireless	General	Use this screen to configure the WiFi settings and WiFi authentication or security settings.
	Guest/More AP	Use this screen to configure multiple BSSs on the Zyxel Device.
	MAC Authentication	Use this screen to block or allow wireless traffic from wireless devices of certain SSIDs and MAC addresses to the Zyxel Device.
	WPS	Use this screen to configure and view your WPS (WiFi Protected Setup) settings.
	WMM	Use this screen to enable or disable WiFi MultiMedia (WMM).
	Others	Use this screen to configure advanced WiFi settings.
	Channel Status	Use this screen to scan WiFi channel noises and view the results.
Home Networking	Mesh	Use this screen to enable or disable Mesh.
	Mesh Topology	Use this screen to configure the MAC address of the extender connected to the Zyxel Device.
	LAN Setup	Use this screen to configure LAN TCP/IP settings, and other advanced properties.
	Static DHCP	Use this screen to assign specific IP addresses to individual MAC addresses.
	UPnP	Use this screen to turn UPnP and UPnP NAT-T on or off.

Table 7 Navigation Panel Summary (continued)

LINK	TAB	FUNCTION
	Additional Subnet	Use this screen to configure IP alias and public static IP.
	Wake on LAN	Use this screen to remotely turn on a device on the local network.
	TFTP Server Name	Use DHCP option 66 to identify a TFTP server name.
Routing	Static Route	Use this screen to view and set up static routes on the Zyxel Device.
	DNS Route	Use this screen to forward DNS queries for certain domain names through a specific WAN interface to its DNS servers.
	Policy Route	Use this screen to configure policy routing on the Zyxel Device.
NAT	Port Forwarding	Use this screen to make your local servers visible to the outside world.
	Port Triggering	Use this screen to change your Zyxel Device's port triggering settings.
	DMZ	Use this screen to configure a default server which receives packets from ports that are not specified in the Port Forwarding screen.
	ALG	Use this screen to enable the ALGs (Application Layer Gateways) in the Zyxel Device to allow applications to operate through NAT.
	Address Mapping	Use this screen to change your Zyxel Device's IP address mapping settings.
	Sessions	Use this screen to configure the maximum number of NAT sessions each client host is allowed to have through the Zyxel Device.
DNS	DNS Entry	Use this screen to view and configure DNS routes.
	Dynamic DNS	Use this screen to allow a static hostname alias for a dynamic IP address.
Security		
Firewall	General	Use this screen to configure the security level of your firewall.
	Protocol	Use this screen to add Internet services and configure firewall rules.
	Access Control	Use this screen to enable specific traffic directions for network services.
	DoS	Use this screen to activate protection against Denial of Service (DoS) attacks.
MAC Filter	MAC Filter	Use this screen to block or allow traffic from devices of certain MAC addresses to the Zyxel Device.
Scheduler Rule	Scheduler Rule	Use this screen to configure the days and times when a configured restriction (such as parental control) is enforced.
System Monitor		
Log	System Log	Use this screen to view the status of events that occurred to the Zyxel Device. You can export or email the logs.

Table 7 Navigation Panel Summary (continued)

LINK	TAB	FUNCTION
	Security Log	Use this screen to view all security related events. You can select the level and category of the security events in their proper drop-down list window. Levels include: <ul style="list-style-type: none"> • Emergency • Alert • Critical • Error • Warning • Notice • Informational • Debugging Categories include: <ul style="list-style-type: none"> • Account • Attack • Firewall • MAC Filter
Traffic Status	WAN	Use this screen to view the status of all network traffic going through the WAN port of the Zyxel Device.
	LAN	Use this screen to view the status of all network traffic going through the LAN ports of the Zyxel Device.
	NAT	Use this screen to view NAT statistics for connected hosts.
ARP table	ARP table	Use this screen to view the ARP table. It displays the IP and MAC address of each DHCP connection.
Routing Table	Routing Table	Use this screen to view the routing table on the Zyxel Device.
WLAN Station Status	WLAN Station Status	Use this screen to view the wireless stations that are currently associated to the Zyxel Device's WiFi.
Maintenance		
Operating Mode	Operating Mode	Use this screen to change the operating mode of the Zyxel Device.
System	System	Use this screen to set the Zyxel Device name and Domain name.
User Account	User Account	Use this screen to change the user password on the Zyxel Device.
Remote Management	MGMT Services	Use this screen to enable specific traffic directions for network services.
	Trust Domain	Use this screen to view a list of public IP addresses which are allowed to access the Zyxel Device through the services configured in the Maintenance > Remote Management screen.
Time	Time	Use this screen to change your Zyxel Device's time and date.
E-mail Notification	E-mail Notification	Use this screen to configure up to two mail servers and sender addresses on the Zyxel Device.
Log Settings	Log Settings	Use this screen to change your Zyxel Device's log settings.
Firmware Upgrade	Firmware Upgrade	Use this screen to upload firmware to your Zyxel Device.
Backup/Restore	Backup/Restore	Use this screen to backup and restore your Zyxel Device's configuration (settings) or reset the factory default settings.
Reboot	Reboot	Use this screen to reboot the Zyxel Device without turning the power off.
Diagnostic	Ping&Traceroute &Nslookup	Use this screen to identify problems with the Zyxel Device. You can use Ping, TraceRoute, or Nslookup to help you identify problems.

3.2.1.3 Dashboard

Use the menu items in the navigation panel on the right to open screens to configure the Zyxel Device's features.

Figure 28 Navigation Panel

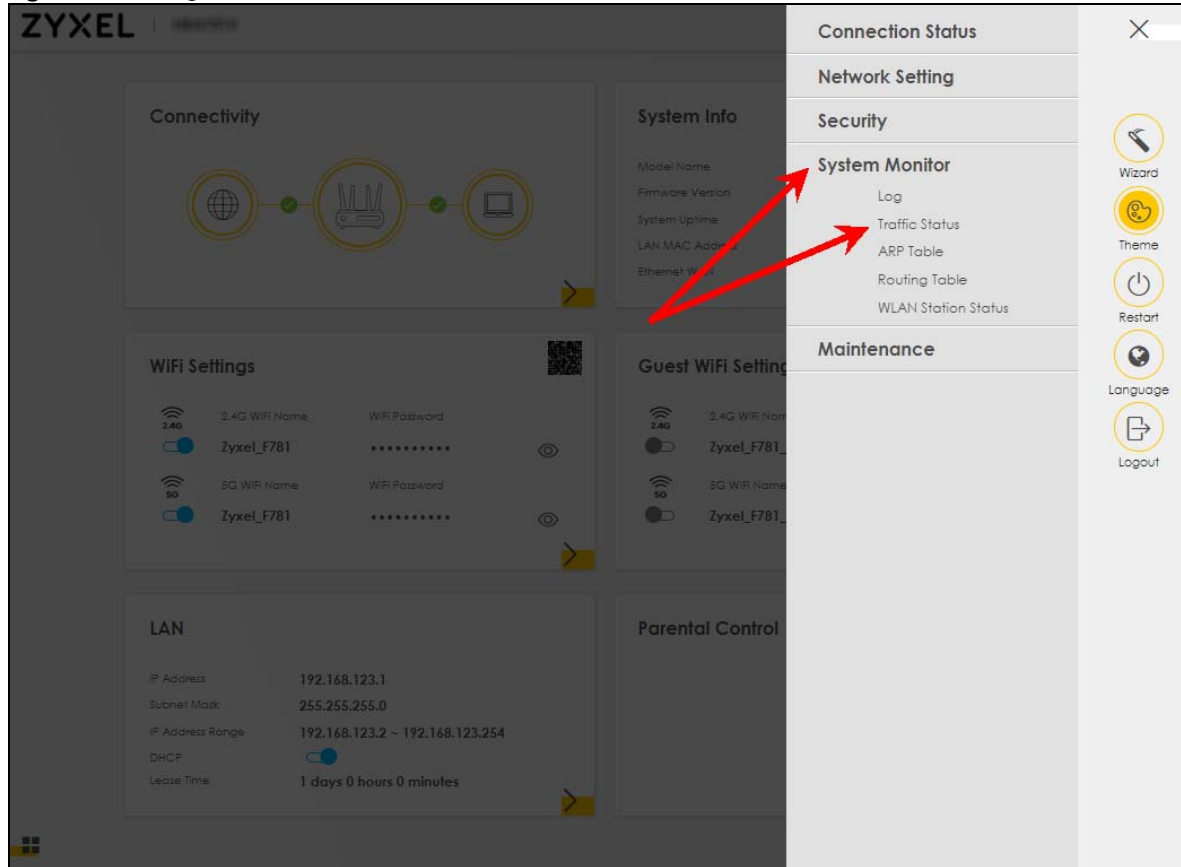

3.2.2 Widget Icon

Click the Widget icon () in the lower left corner to arrange the screen order.

The following screen appears. Select a block and hold it to move around. Click the Check icon () in the lower left corner to save the changes.

Figure 29 Screen Order



CHAPTER 4

Quick Start

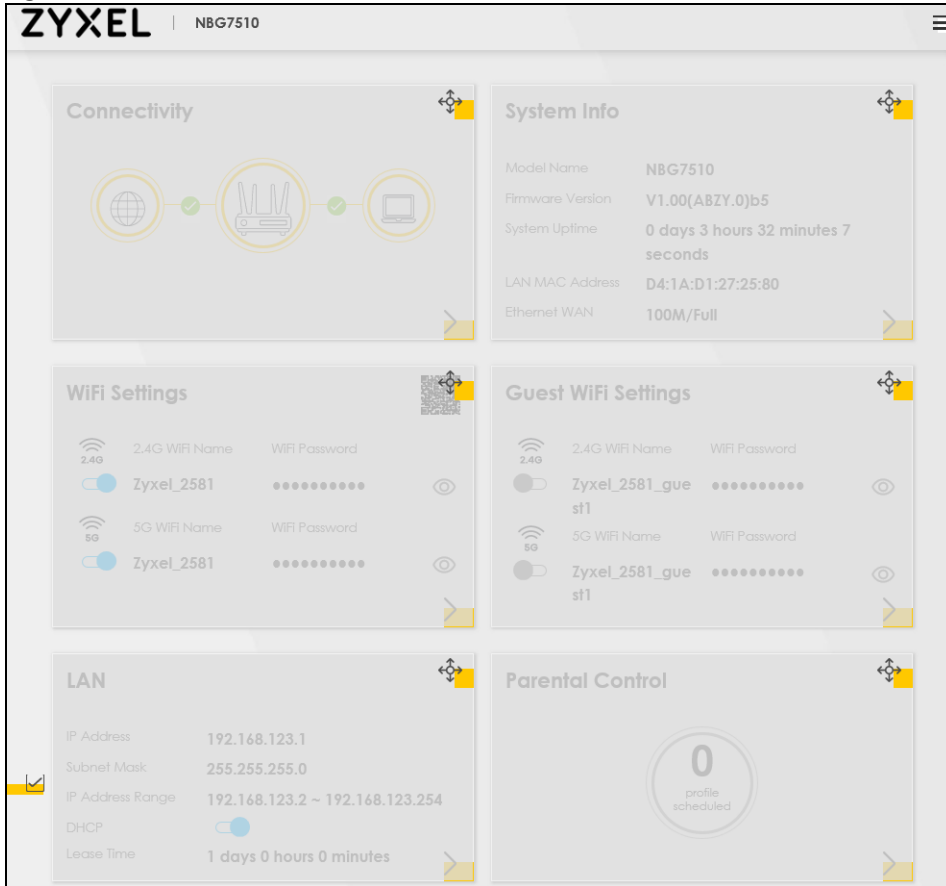
4.1 Quick Start Overview

Use the **Wizard** screens to configure the Zyxel Device's time zone and WiFi settings.

Note: See the technical reference chapters for background information on the features in this chapter.

4.2 Quick Start Setup

You can click the **Wizard** icon in the side bar to open the **Wizard** screens. After you click the **Wizard** icon, the following screen appears. Click **Let's go** to proceed with settings on time zone and WiFi networks. It will take you a few minutes to complete the settings on the **Wizard** screens. You can click **Skip** to leave the **Wizard** screens.

Figure 30 Wizard – Home

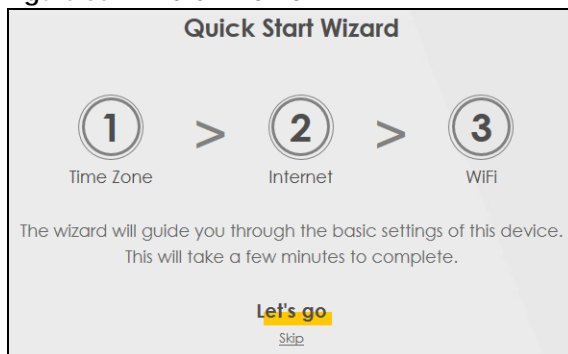

4.3 Quick Start Setup – Time Zone

Select the time zone of the Zyxel Device's location. Click **Next**.

Figure 31 Wizard – Time Zone

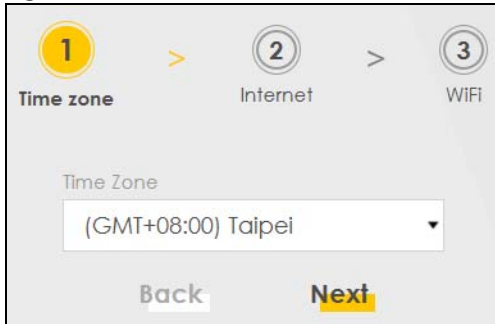

4.4 Quick Start Setup – Internet Connection

The Zyxel Device detects your Internet connection status. Click **Next** to continue.

Figure 32 Wizard – Internet

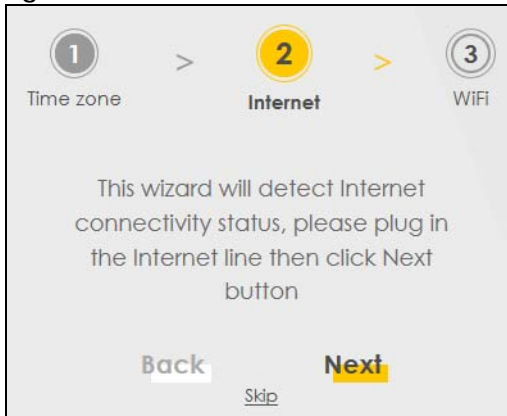

4.4.1 Successful Internet Connection

The Zyxel Device has Internet access.

Figure 33 Wizard – Successful Internet Connection



4.4.2 Unsuccessful Internet Connection

The Zyxel Device did not detect a WAN connection. See [Section 32.4 on page 258](#) for troubleshooting the Zyxel Device WAN connection.

Figure 34 Wizard – Internet Connection is Down



4.5 Quick Start Setup – WiFi

Turn WiFi on or off. If you keep it on, record the **WiFi Name** and **Password** in this screen so you can configure your WiFi clients to connect to the Zyxel Device. If you want to show or hide your WiFi password, click the Eye icon (👁).

Figure 35 Wizard - WiFi

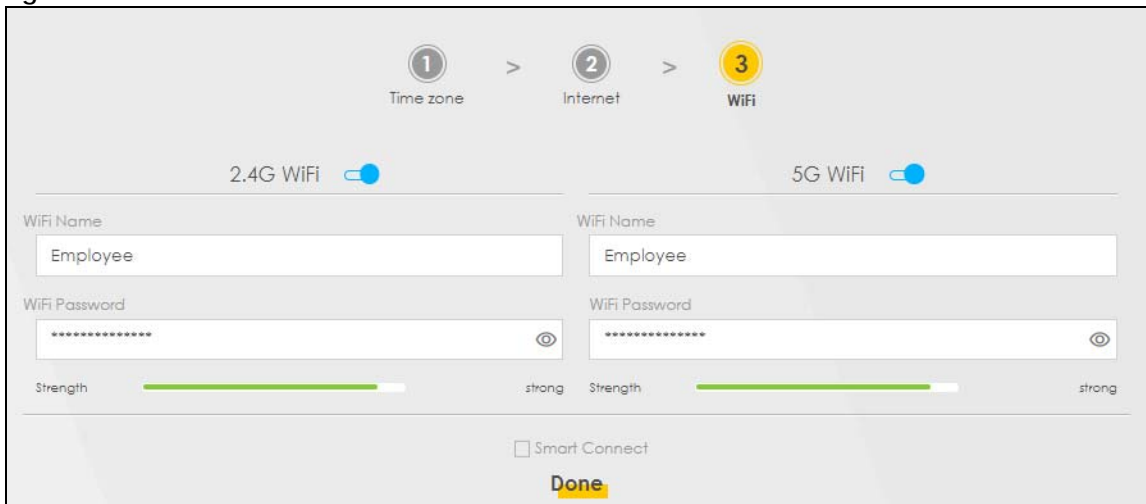

Click the **Smart Connect** check box to use the same SSID for 2.4G and 5G WiFi networks. Otherwise, deselect the check box to have two different SSIDs for 2.4G and 5G WiFi networks. The screen and fields to enter may vary when you select or deselect the check box.

Figure 36 Wizard - WiFi – Smart Connect

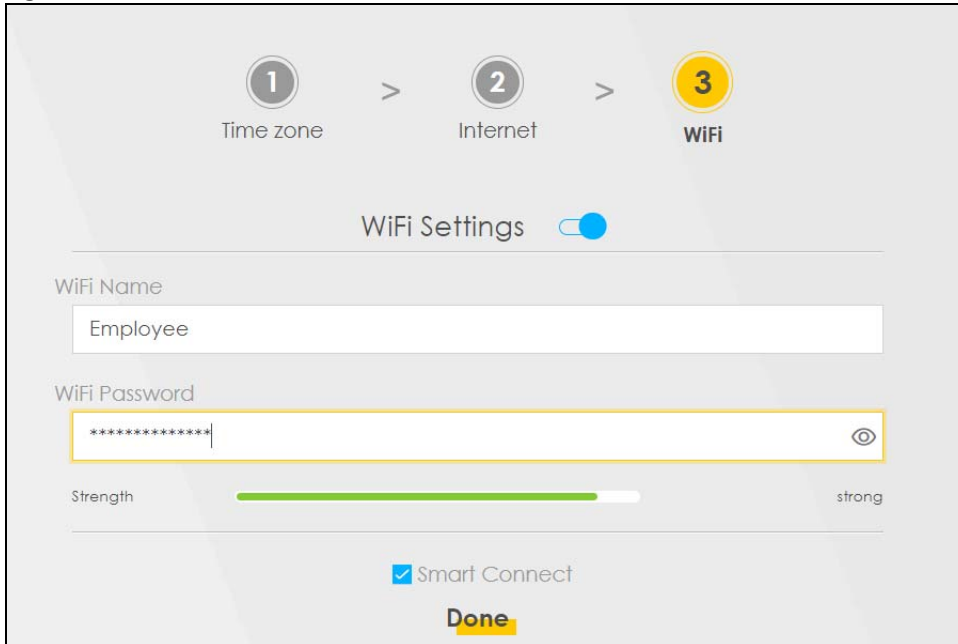

4.6 Quick Start Setup – Finish

Your Zyxel Device saves your settings and attempts to connect to the Internet.

CHAPTER 5

Web Interface Tutorials

5.1 Web Interface Overview

This chapter shows you how to use the Zyxel Device's various features.

- [Wired Network Setup](#)
- [WiFi Network Setup](#)
- [Network Security](#)
- [Device Maintenance](#)

5.2 Wired Network Setup

This section shows you how to set up a wired connection.

Set the Zyxel Device to **Routing** mode or **Bridge** mode on this connection as follows:

- Use **Routing** mode if you want the Zyxel Device to use routing mode functions such as **NAT**, **Firewall**, or **DHCP Server**. You will need to reconfigure your network if you have an existing router.
- Use **Bridge** mode to pass the ISP-assigned IP address(es) to your devices connected to the LAN port. All traffic from the Internet passes through the Zyxel Device directly to devices connected to the LAN port. Use this mode if you already have a router with complete routing functions in your network.

5.2.1 Setting Up an Ethernet Connection

If you connect to the Internet through an Ethernet connection, you need to connect a broadband modem or router with Internet access to the WAN Ethernet port on the Zyxel Device. You need to configure the Internet settings from the broadband modem or router on the Zyxel Device. First, make sure you have Internet access through the broadband modem or router by connecting directly to it.

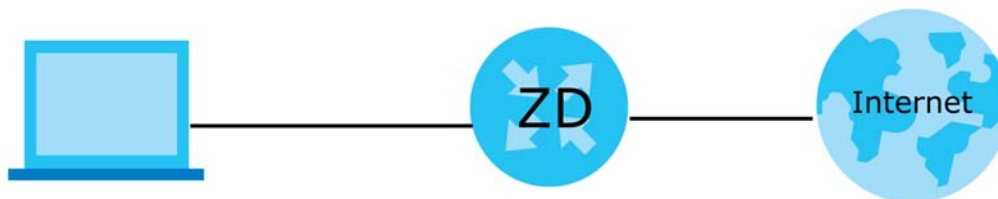

This example shows you how to configure an Ethernet WAN connection.

- 1 Make sure you have the Ethernet WAN port connect to a modem or router.

- 2 Go to **Network Setting > Broadband** and then the following screen appears. Click the Modify icon to edit the information.

Broadband												
Use this screen to change your Zyxel Device's Internet access settings. The summary table shows you the configured WAN services (connections) on the Zyxel Device. Use information provided by your ISP to configure WAN settings.												
#	Name	Type	Mode	Encapsulation	802.1p	802.1q	IGMP Proxy	NAT	Default Gateway	IPv6	MLD Proxy	Modify
1	ETHWAN	ETH	Routing	IPoE	N/A	N/A	Y	Y	Y	Y	Y	

- 3 To set the Zyxel Device to **Routing** mode, see [Section 1 on page 45](#).

To set the Zyxel Device to **Bridge** mode, see [Section 1 on page 46](#).

Routing Mode

- 1 In this routing mode example, configure the following information for the Ethernet WAN connection.

General	
Name	My ETH Connection
Type	Ethernet
Connection Mode	Routing
Encapsulation (Internet Type)	IPoE
IPv6/IPv4 Mode	IPv4 Only

- 2 Enter the **General** settings provided by your Internet service provider.
- 2a Enter a **Name** to identify your WAN connection.
 - 2b Set the **Type** to **Ethernet**.
 - 2c Set your Ethernet connection **Mode** to **Routing**.
 - 2d Choose the **Encapsulation** specified by your Internet service provider. For this example, select **IPoE** as the WAN encapsulation type.
 - 2e Set the **IPv4/IPv6 Mode** to **IPv4 Only**.
- 3 Under **Routing Feature**, enable **NAT** and **Apply as Default Gateway**.
- 4 For the rest of the fields, use the default settings.
- 5 Click **Apply** to save your settings.

- 6 Go to the **Network Setting > Broadband** screen to view the established Ethernet connection. The new connection is displayed on the **Broadband** screen.

#	Name	Type	Mode	Encapsulation	802.1p	802.1q	IGMP Proxy	NAT	Default Gateway	IPv6	MLD Proxy	Modify
1	My ETH Connecti	ETH	Routing	IPoE	N/A	N/A	N	Y	Y	N	N	

Bridge Mode

- 1 In this bridge mode example, configure the following information for the Ethernet WAN connection.

General	
Name	My ETH Connection
Type	Ethernet
Connection Mode	Bridge

- 2 Enter the **General** settings provided by your Internet service provider.
- 2a** Enter a **Name** to identify your WAN connection.
- 2b** Set the **Type** to **Ethernet**.

- 2c Set your Ethernet connection **Mode** to **Bridge**.
- 3 For the rest of the fields, use the default settings.
- 4 Click **Apply** to save your settings.

The screenshot shows the 'Edit WAN Interface' configuration page. On the left, the 'General' tab is selected, with a blue toggle switch. Below it, the 'Name' field contains 'My ETH Connection', the 'Type' dropdown is set to 'Ethernet', and the 'Mode' dropdown is set to 'Bridge'. On the right, the 'VLAN' tab is visible with a grey toggle switch. Below it, the '802.1p' field contains '0' and the '802.1q' field contains '0' with a '(0~4094)' range indicator. At the bottom, the 'Apply' button is circled in red, and the 'Cancel' button is to its left.

5.3 WiFi Network Setup

In this example, you want to set up a WiFi network so that you can use your notebook to access the Internet. In this WiFi network, the Zyxel Device is an access point (AP), and the notebook is a WiFi client. The WiFi client can access the Internet through the AP.

Figure 37 WiFi Network Setup

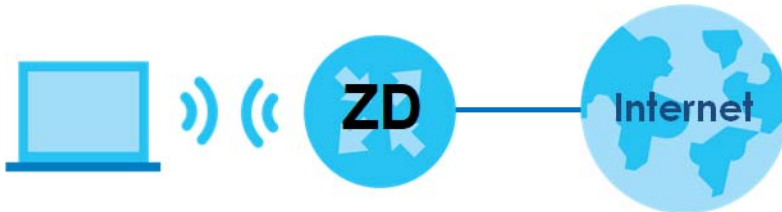

See the label on the Zyxel Device for the WiFi network settings and then connect manually to the Zyxel Device. Alternatively, you can set up a WiFi network using WPS. See [Section 5.3.2 on page 50](#).

5.3.1 Changing Security on a WiFi Network

This example changes the default security settings of a WiFi network to the following:

SSID	Example
Security Mode	WPA3-SAE/WPA2-PSK
Pre-Shared Key	DoNotStealMyWiFi
802.11 Mode	802.11b/g/n Mixed

- 1 Go to the **Network Setting > Wireless > General** screen. Select **More Secure** as the security level and **WPA3-SAE/WPA2-PSK** as the security mode. Configure the screen using the provided parameters. Click **Apply**.

Use this screen to enable the Wireless LAN, enter the SSID and select the wireless security mode. We recommend that you select **More Secure** to enable **WPA3-SAE/WPA2-PSK** data encryption.

Wireless

Wireless Smart Connect

Wireless Network Setup

Band: 2.4GHz

Wireless:

Channel: Auto Current: 5 / 40 MHz

Bandwidth: 20/40MHz

Control Sideband: Upper

Wireless Network Settings

Wireless Network Name: Example

Max Clients: 32

Hide SSID i

Multicast Forwarding

Note

(1) If you are configuring the Zyxel Device from a computer connected by WiFi and you change the Zyxel Device's SSID, channel or security settings, you will lose your WiFi connection when you press **Apply**. You must change the WiFi settings of your computer to match the new settings on the Zyxel Device.

BSSID: D4:1A:D1:3F:F8:01

Security Level

No Security
More Secure (Recommended)

Security Mode: WPA3-SAE/WPA2-PSK

Generate password automatically

Enter 8-63 ASCII characters or 64 hexadecimal digits ("0-9", "A-F").

Password: DoNotStealMyWiFi 🔍

Strength: strong

Cancel
Apply

- 2 Go to the **Wireless > Others** screen. Set **802.11 Mode** to **802.11b/g/n Mixed**, and then click **Apply**.

Wireless

General | Guest/More AP | MAC Authentication | WPS | WMM | **Others** | Channel Status | MESH

The configurations below are the advanced wireless settings.

RTS/CTS Threshold	2347
Fragmentation Threshold	2346
Output Power	100%
Beacon Interval	100 ms
DTIM Interval	1 ms
802.11 Mode	802.11b/g/n Mixed
802.11 Protection	Auto
Preamble	Long
Protected Management Frames	Capable

Cancel Apply

You can now use the WPS feature to establish a WiFi connection between your notebook and the Zyxel Device (see [Section 5.3.2 on page 50](#)). Now use the new security settings to connect to the Internet through the Zyxel Device using WiFi.

5.3.2 Connecting to the Zyxel Device's WiFi Network Using WPS

This section shows you how to connect a WiFi device to the Zyxel Device's WiFi network using WPS. WPS (Wi-Fi Protected Setup) is a security standard that allows devices to connect to a router securely without you having to enter a password. There are two methods:

- **Push Button Configuration (PBC)** – Connect to the WiFi network by pressing a button. This is the simplest method.

5.3.2.1 WPS Push Button Configuration (PBC)

This example shows how to connect to the Zyxel Device's WiFi network from a notebook computer running Windows 10.

- 1 Make sure that your Zyxel Device is turned on, and your notebook is within range of the Zyxel Device's WiFi signal.
- 2 Push and hold the **WPS** button located on the Zyxel Device until the **WiFi** or **WPS** LED starts blinking slowly. Alternatively, log into the Zyxel Device's Web Configurator, and then go to the **Network Setting > Wireless > WPS** screen. Enable **WPS** and **Method 1 PBC**, click **Apply**, and then click the **WPS button**.

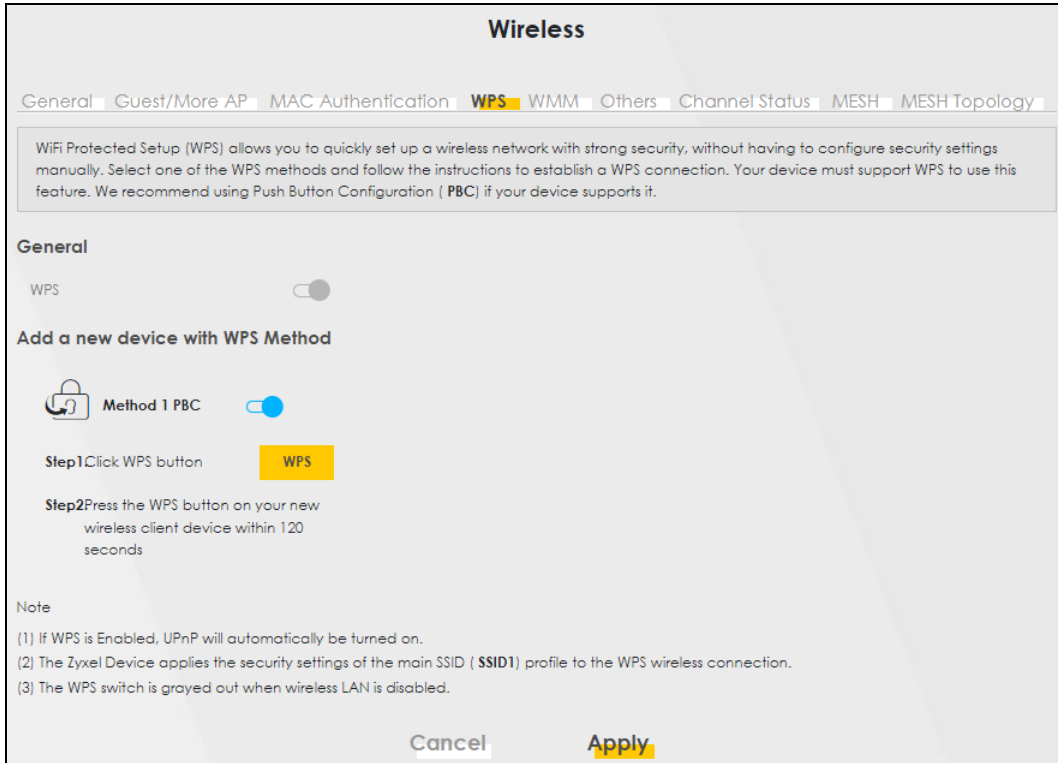

- 3 In Windows 10, click on the Network icon in the system tray to open the list of available WiFi networks.



- 4 Locate the WiFi network of the Zyxel Device. The default WiFi network name is "Zyxel_XXXX" (2.4G) or "Zyxel_XXXX_5G" (5G). Then click **Connect**.

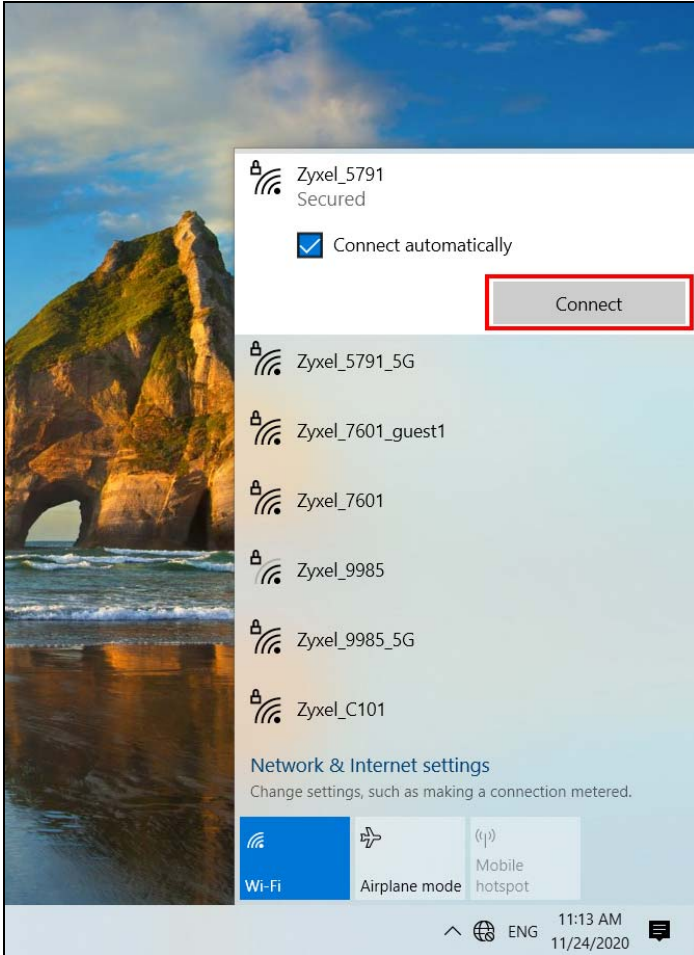

The Zyxel Device sends the WiFi network settings to Windows using WPS. Windows displays "Getting settings from the router".

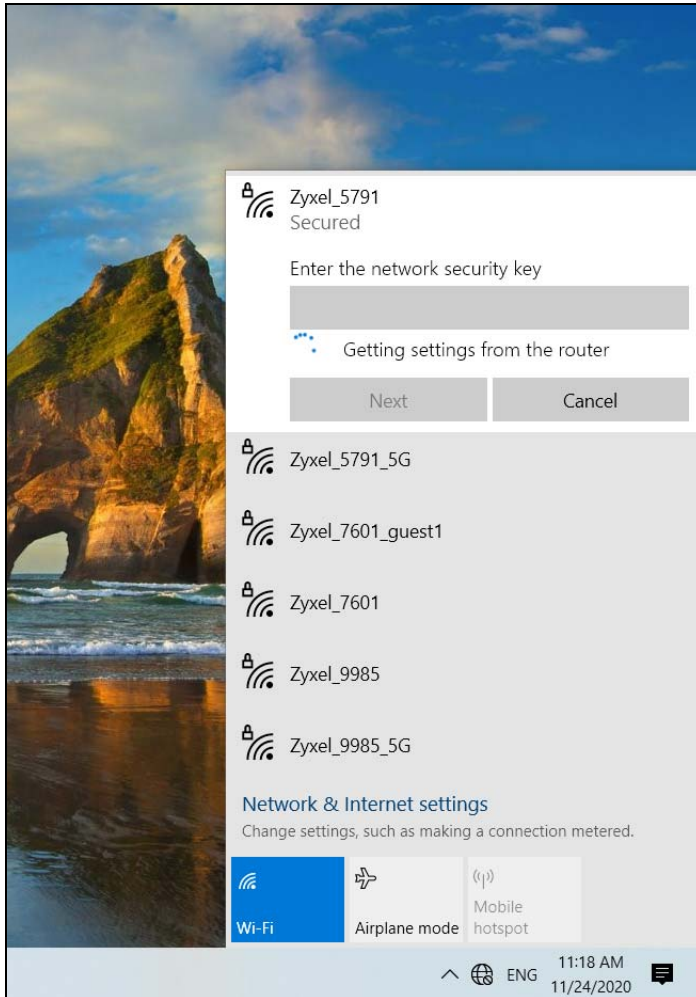

The WiFi device is then able to connect to the WiFi network securely.

5.3.3 Setting Up a Guest Network

A company wants to create two WiFi networks for different groups of users as shown in the following figure. Each WiFi network has its own SSID and security mode. Both networks are accessible on both 2.4G and 5G WiFi bands.

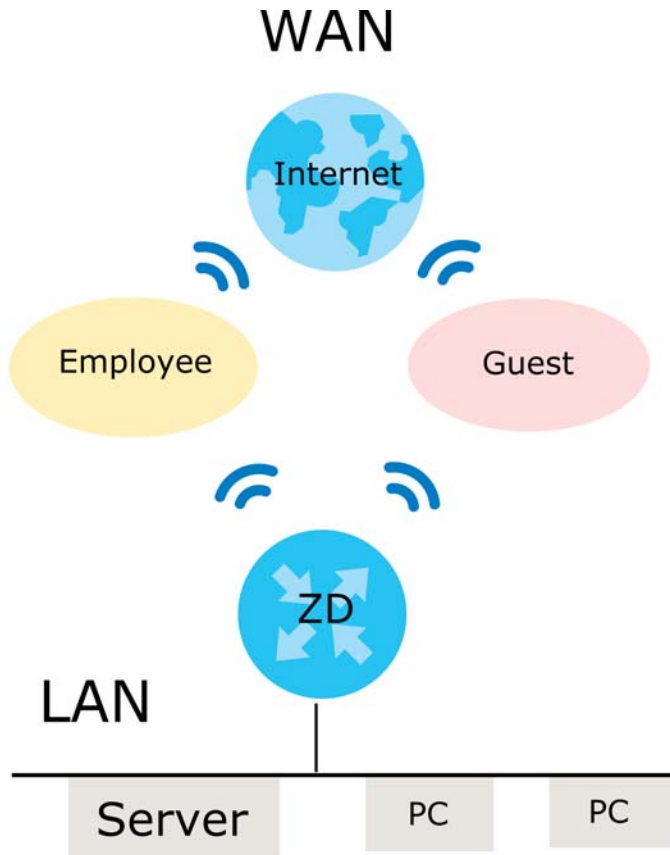

- Employees using the **General** WiFi network group will have access to the local network and the Internet.
- Visitors using the **Guest** WiFi network group with a different SSID and password will have access to the Internet only.

Use the following parameters to set up the WiFi network groups.

	GENERAL	GUEST
2.4/5G SSID	Employee	Guest
Security Level	More Secure	More Secure
Security Mode	WPA2-PSK	WPA2-PSK
Pre-Shared Key	ForCompanyOnly	guest123

- 1 Go to the **Network Setting > Wireless > General** screen. Use this screen to set up the company's general WiFi network group. Configure the screen using the provided parameters and click **Apply**. Note that if you have employees using 2.4G and 5G devices, enable **Smart Connect** to use the same SSID and password. Clear it if you want to configure different SSIDs and passwords for 2.4G and 5G bands.

Use this screen to enable the Wireless LAN, enter the SSID and select the wireless security mode. We recommend that you select **More Secure** to enable **WPA3-SAE/WPA2-PSK** data encryption.

Wireless

Wireless Smart Connect

Wireless Network Setup

Band: 2.4GHz

Wireless:

Channel: Auto Current: 5 / 40 MHz

Bandwidth: 20/40MHz

Control Sideband: Upper

Wireless Network Settings

Wireless Network Name: Employee

Max Clients: 32

Hide SSID i

Multicast Forwarding

Note

(1) If you are configuring the Zyxel Device from a computer connected by WiFi and you change the Zyxel Device's SSID, channel or security settings, you will lose your WiFi connection when you press **Apply**. You must change the WiFi settings of your computer to match the new settings on the Zyxel Device.

BSSID: D4:1A:D1:3F:F8:01

Security Level

No Security More Secure (Recommended)

Security Mode: WPA2-PSK

Generate password automatically



Enter 8-63 ASCII characters or 64 hexadecimal digits ("0-9", "A-F").

Password: ForCompanyOnly 🗨

Strength: medium

Cancel Apply

- Go to the **Network Setting > Wireless > Guest/More AP** screen. Click the **Modify** icon to configure the second WiFi network group.

#	Status	SSID	Security	Guest WLAN	Modify
1		Guest	WPA2-Personal	External Guest	

- On the **Guest/More AP** screen, click the **Modify** icon to configure the other Guest WiFi network group. Configure the screen using the provided parameters and click **OK**.

More AP Edit

Use this screen to create Guest and additional wireless networks with different security settings.

Wireless Network Setup

Wireless

Wireless Network Settings

Wireless Network Name

Hide SSID

Guest WLAN

Access Scenario 

BSSID

SSID Subnet

Security Level

No Security
More Secure
(Recommended)



Security Mode

Generate password automatically
Enter 8-63 ASCII characters or 64 hexadecimal digits ("0-9", "A-F").

Password 

Strength weak

Cancel
OK

- Check the status of **Guest** in the **Guest/More AP** screen. A yellow bulb under **Status** means the SSID is active and ready for WiFi access.

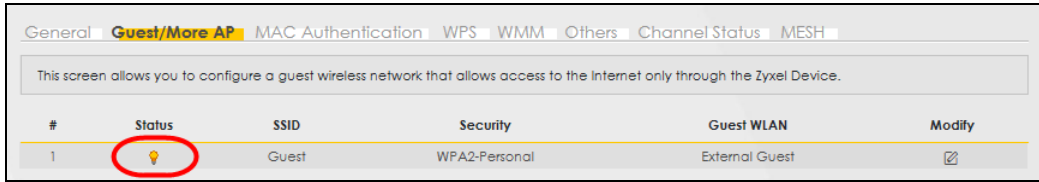

5.3.4 Setting Up Two Guest WiFi Networks on Different WiFi Bands

In this example, a company wants to create two Guest WiFi networks: one for the **Guest** group and the other for the **VIP** group as shown in the following figure. Each network will have its SSID and security mode to access the internet.

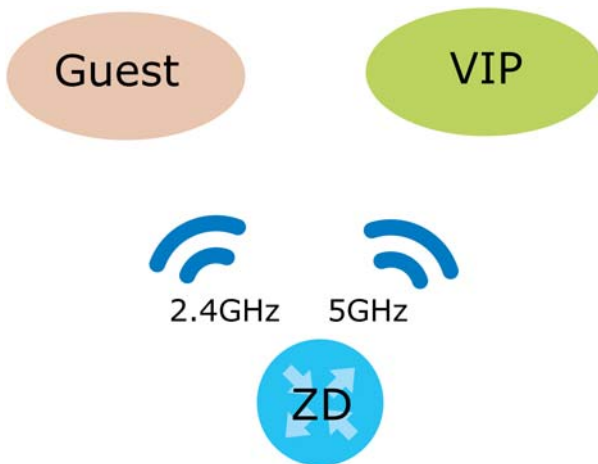

- The **Guest** group will use the 2.4G band.
- The **VIP** group will use the 5G band.

The Company will use the following parameters to set up the WiFi network groups.

Table 8 WiFi Settings Parameters Example

BAND	2.4G	5G
SSID	Guest	VIP
Security Mode	WPA3-SAE/WPA2-PSK	WPA3-SAE/WPA2-PSK
Pre-Shared Key	guest123	123456789

- 1 Go to the **Wireless > General** screen and set **Band** to **2.4GHz** to configure 2.4G Guest WiFi settings for **Guest**. Click **Apply**.

Note: You will not be able to configure the 2.4G and 5G Guest WiFi settings separately if **Smart Connect** is enabled.

General Guest/More AP MAC Authentication WPS WMM Others Channel Status Mesh Mesh Topology

Use this screen to enable the Wireless LAN, enter the SSID and select the wireless security mode. We recommend that you select **More Secure** to enable **WPA3-SAE/WPA2-PSK** data encryption.

Wireless

Wireless Smart Connect

Wireless Network Setup

Band 2.4GHz

Wireless

Channel Auto Current: 5 / 40 MHz

Bandwidth 20/40MHz

Control Sideband Upper

Wireless Network Settings

Wireless Network Name Guest

Max Clients 32

Hide SSID i

Multicast Forwarding

Note

(1) If you are configuring the Zyxel Device from a computer connected by WIFI and you change the Zyxel Device's SSID, channel or security settings, you will lose your WIFI connection when you press **Apply**. You must change the WIFI settings of your computer to match the new settings on the Zyxel Device.

BSSID D4:1A:D1:3F:F8:01

Security Level

No Security More Secure (Recommended)

Security Mode WPA3-SAE/WPA2-PSK

Generate password automatically

Enter 8-63 ASCII characters or 64 hexadecimal digits ("0-9", "A-F").

Password guest123 👁

Strength weak

Cancel **Apply**

- Go to the **Wireless > Guest/More AP** screen and click the **Modify** icon. The following screen appears. Configure the **Security Mode** and **Password** using the provided parameters and click **OK**.

Use this screen to create Guest and additional wireless networks with different security settings.

Wireless Network Setup

Wireless

Wireless Network Settings

Wireless Network Name

Hide SSID

Guest WLAN

Access Scenario 5GHz

BSSID 00:00:00:00:00:00

SSID Subnet

Security Level

No Security More Secure (Recommended)

Generate password automatically
Enter 8-63 ASCII characters or 64 hexadecimal digits ("0-9", "A-F").

Password 👁

Strength weak

Cancel OK

The 2.4 GHz **Guest** WiFi network is now configured.

Wireless

General **Guest/More AP** MAC Authentication WPS WMM Others Channel Status MESH

This screen allows you to configure a guest wireless network that allows access to the Internet only through the Zyxel Device.

#	Status	SSID	Security	Guest WLAN	Modify
1	🔦	Guest	WPA2-Personal	External Guest	✎

- Go to the **Wireless > General** screen and set **Band** to **5GHz** to configure the 5G Guest WiFi settings for **VIP**. Click **OK**.

General Guest/More AP MAC Authentication WPS WMM Others Channel Status Mesh Mesh Topology

Use this screen to enable the Wireless LAN, enter the SSID and select the wireless security mode. We recommend that you select **More Secure** to enable **WPA3-SAE/WPA2-PSK** data encryption.

Wireless

Wireless Smart Connect

Wireless Network Setup

Band 5GHz

Wireless

Channel Auto Current: 153 / 80 MHz

Bandwidth 20/40/80MHz

Control Sideband None

Wireless Network Settings

Wireless Network Name VIP

Max Clients 32

Hide SSID i

Multicast Forwarding

Note

(1) If you are configuring the Zyxel Device from a computer connected by WIFI and you change the Zyxel Device's SSID, channel or security settings, you will lose your WIFI connection when you press **Apply**. You must change the WIFI settings of your computer to match the new settings on the Zyxel Device.

BSSID D4:1A:D1:3F:F8:02

Security Level

No Security More Secure (Recommended)

▼

Security Mode WPA2-PSK

Generate password automatically

Enter 8-63 ASCII characters or 64 hexadecimal digits ("0-9"; "A-F").

Password 123456789 👁

Strength weak

Cancel Apply

- 4 Go to the **Wireless > Guest/More AP** screen and click the **Modify** icon. The following screen appears. Configure the **Security Mode** and **Password** using the provided parameters and click **OK**.

The 5G **VIP** WiFi network is now configured.

#	Status	SSID	Security	Guest WLAN	Modify
1	On	VIP	WPA2-Personal	External Guest	

5.4 Network Security

This section shows you how to configure a Firewall rule, Parental Control rule, and MAC Filter rule.

5.4.1 Configuring a Firewall Rule

You can enable the firewall to protect your LAN computers from malicious attacks from the Internet.

- 1 Go to the **Security > Firewall > General** screen.
- 2 Select **IPv4 Firewall/IPv6 Firewall** to enable the firewall, and then click **Apply**.

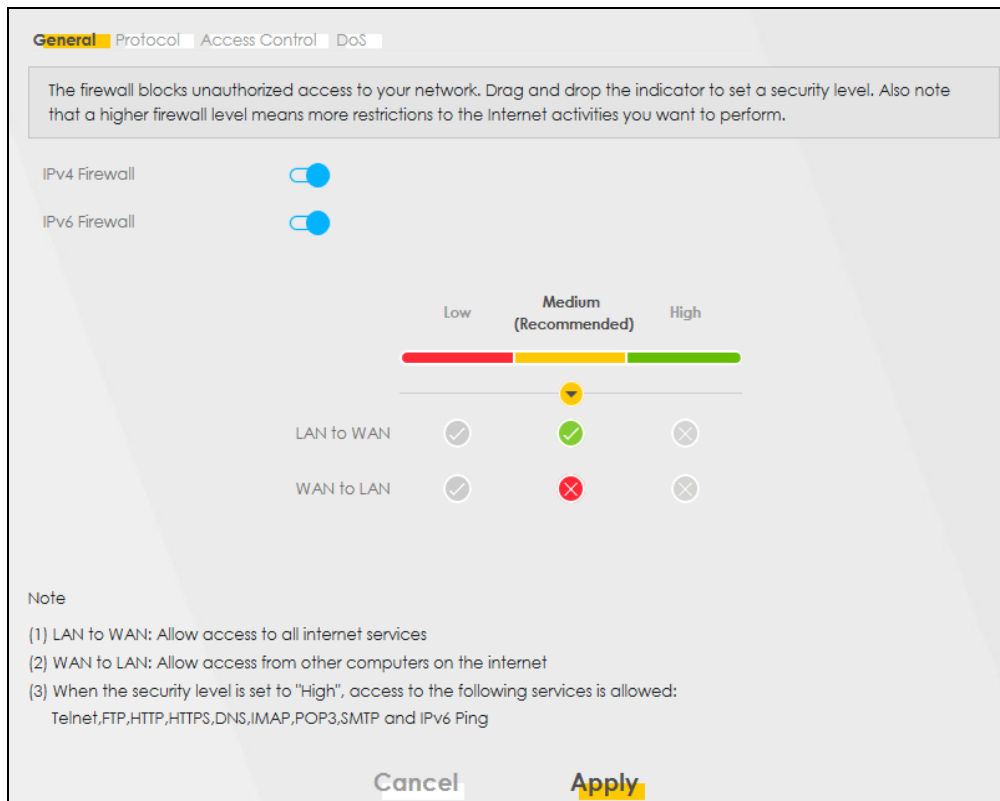

- 3 Open the **Access Control** screen ,click **Add New ACL Rule** to create a rule.

Firewall

General Protocol **Access Control** DoS

An Access Control List (ACL) rule is a manually-defined rule that can accept, reject, or drop incoming or outgoing packets from your network based on the type of service. For example, you could block users using Instant Messaging in your network. This screen displays a list of the configured incoming or outgoing filtering rules. Note the order in which the rules are listed.

The ordering of your rules is very important as rules are applied in turn.

Rules Storage Space Usage 0%

[+ Add New ACL Rule](#)

#	Name	Src IP	Dest IP	Service	Action	Modify
---	------	--------	---------	---------	--------	--------

- 4 Use the following fields to configure and apply a new ACL (Access Control List) rule.

Add New ACL Rule

<

Filter Name

Order ▼

Select Source Device ▼

Source IP Address [/prefix length]

Select Destination Device ▼

Destination IP Address [/prefix length]

IP Type ▼

Select Service ▼

Protocol ▼

Custom Source Port -

Custom Destination Port -

Policy ▼

Direction ▼

[Cancel](#) [OK](#)

- **Filter Name:** Enter a name to identify the firewall rule.
- **Source IP Address:** Enter the IP address of the computer that initializes traffic for the application or service.

- **Destination IP Address:** Enter the IP address of the computer to which traffic for the application or service is entering.
- **Protocol:** Select the protocol (**ALL, TCP/UDP, TCP, UDP, ICMP** or **ICMPv6**) used to transport the packets.
- **Policy:** Select whether to (**ACCEPT, DROP, or REJECT**) the packets.
- **Direction:** Select the direction (**WAN to LAN, LAN to WAN, WAN to ROUTER, or LAN to ROUTER**) of the traffic to which this rule applies.

5 Select **Enable Rate Limit** to activate the rules you created. Click **OK**.

5.4.2 Parental Control

This section shows you how to configure rules for accessing the Internet using parental control.

Note: The style and features of your parental control vary depending on the Zyxel Device you are using.

5.4.2.1 Configuring Parental Control Schedule and Filter

Parental Control Profile (**PCP**) allows you to set up a rule for:

- Internet usage scheduling.
- Websites and URL keyword blocking.

Use this feature to:

- Limit the days and times a user can access the Internet.
- Limit the websites a user can access on the Internet.

This example shows you how to block a user from accessing the Internet during time for studying. It also shows you how to stop a user from accessing specific websites.

Use the parameters below to configure a schedule rule and a URL keyword blocking rule.

PROFILE NAME	INTERNET ACCESS SCHEDULE	NETWORK SERVICE	SITE/ URL KEYWORD
Study	Day: Monday to Friday Time: 8:00 to 11:00 13:00 to 17:00	Network Service Setting: Block Service Name: HTTP Protocol: TCP Port: 80	Block or Allow the Web Site: Block the web URLs Website: gambling

Parental Control Screen

Open the **Parental Control** screen. Select **Enable** under **General** to enable parental control. Then click **Add New PCP** to add a rule.

Parental Control

Parental control allows you to limit the time a user can access the Internet and prevent users from viewing inappropriate content or participating in specified online activities.

Use this screen to enable parental control and view parental control rules and schedules. You can limit the time a user can access the Internet and prevent users from viewing inappropriate content or participating in specified online activities. These rules are defined in a Parental Control Profile (PCP).

General

Parental Control Enable Disable (Settings are invalid when disable)

Parental Control Profile(PCP) + Add New PCP

#	Status	PCP Name	Home Network User MAC	Internet Access Schedule	Network Service	Website Blocked	Modify
Cancel Apply							

Add New PCP Screen

- 1 Go to Parental Control > Add New PCP. Under **General**:
 - 1a Select **Enable** to enable the rule you are configuring.
 - 1b Enter the **Parental Control Profile Name** given in the above parameter.
 - 1c Select an user this rule applies to in **Home Network User**, then click **Add**. You will see the MAC address of the user you just select in **Rule List**.

General

Active Enable Disable (Settings are invalid when disable)

Parental Control Profile Name

Home Network User Add

Rule List

User MAC Address	Delete
DC-4A-3E-40-EC-67	Delete

- 2 Under **Internet Access Schedule**:
 - 2a Click **Add New Time** to add a second schedule.

2b Use the parameter give above to configure the time settings of your schedule.

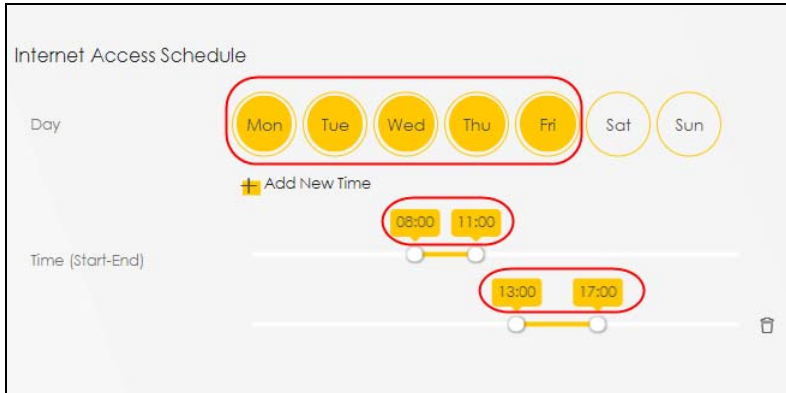

3 Under **Network Service**:

3a In **Network Service Setting**, select **Block**.

3b Click **Add New Service**, then use the parameter given above to configure settings for the Internet service you are blocking.

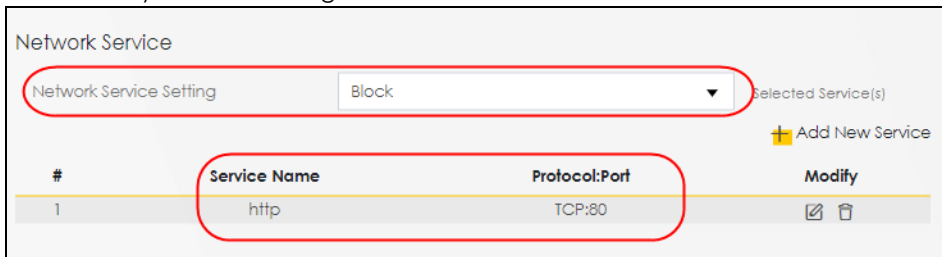

4 Under **Site / URL Keyword**:

4a Select **Block the web URLs** in **Block or Allow the Web Site**.

4b Click **Add**, then use the parameter given above to configure settings for the URL keyword you are blocking.

4c Select **Redirect blocked site to Zyxel Family Safety page** to redirect the web browser to the Zyxel Family Safety page if he or she tries to access a website with the blocked URL keyword.

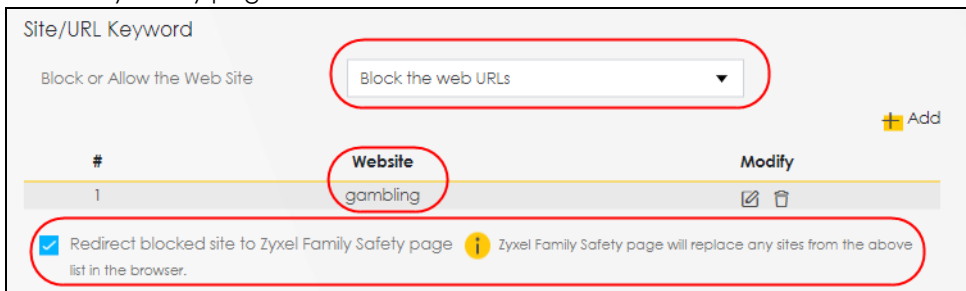

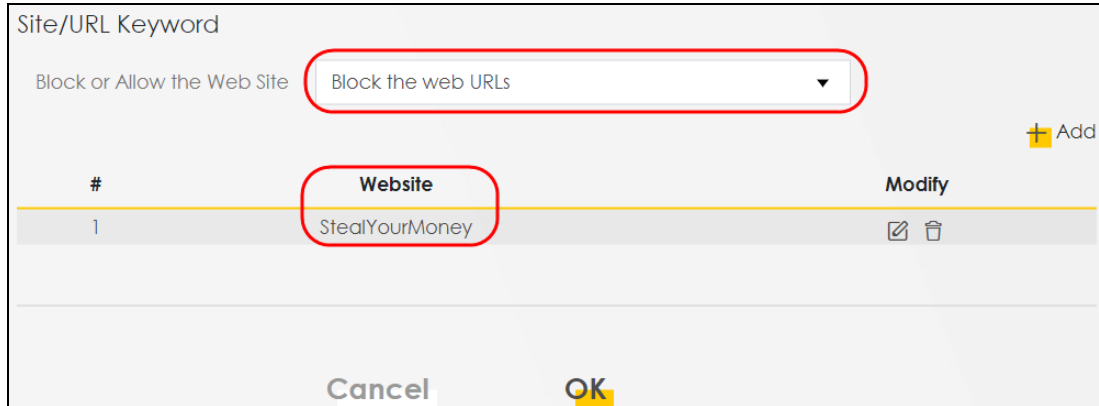

- 5 Click **OK** to save your settings.

5.4.2.2 Configuring a Parental Control Schedule

Parental Control Profile allows you to set up a schedule rule for Internet usage. Use this feature to limit the days and times a user can access the Internet.

This example shows you how to block an user from accessing the Internet during time for studying. Use the parameter below to configure a schedule rule.

PROFILE NAME	START BLOCKING	END BLOCKING	REPEAT ON
Study	8:00 am	11:00 am	from Monday to Friday
	1:00 pm	5:00 pm	from Monday to Friday

- 1 Click **Add more Profile** to open the **Parental Control** screen.

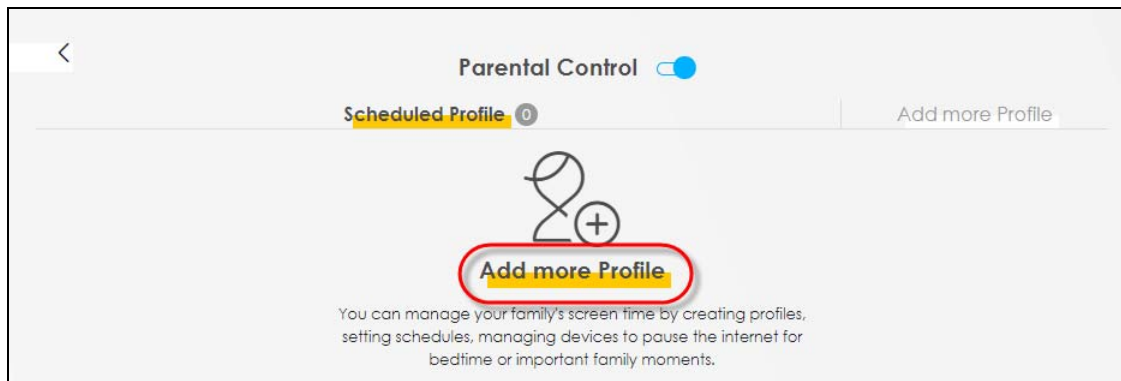

- 2 Use this screen to add a Parental Control rule.
 - 2a Enter the **Profile Name** given in the above parameter.
 - 2b Click on the switch to enable **Profile Active**.
 - 2c Select a device, and then click **Next** to proceed.

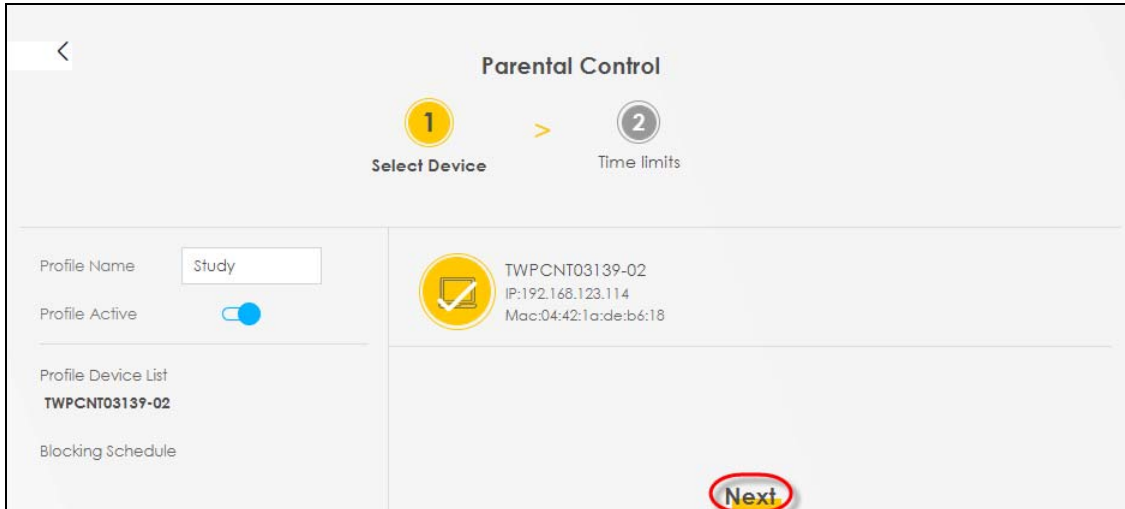

3 Use this screen to edit the Parental Control schedule.

3a Click **Add New Schedule** to add a second schedule.

3b Use the parameter given above to configure the time settings of your schedules.

3c Click **Save** to save the settings.

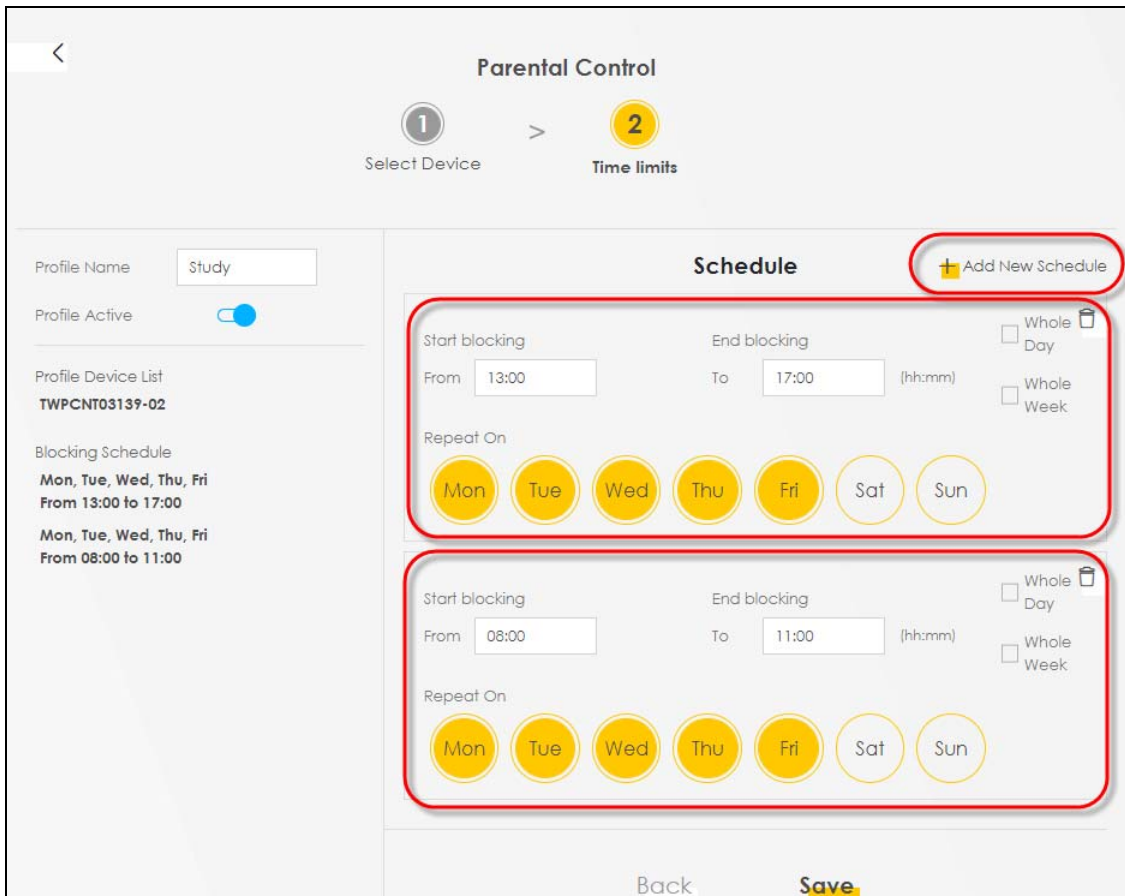

5.4.3 Configuring a MAC Address Filter for Wired LAN Connections

You can use a MAC address filter to exclusively allow or permanently block someone from the wired LAN network.

This example shows that computer B is not allowed access to the wired LAN network.

Figure 38 Configure a MAC Address Filter Example

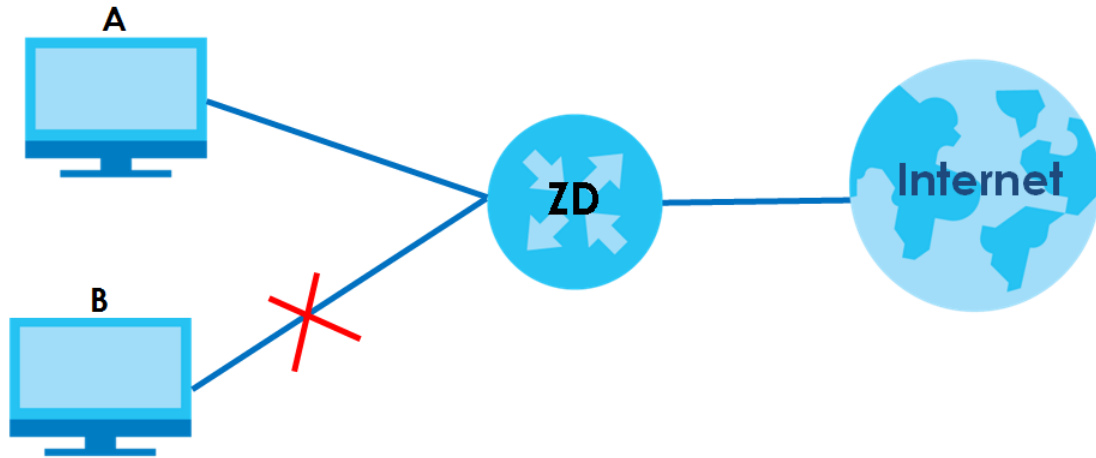

- 1 Go to the **Security > MAC Filter > MAC Filter** screen. Under **MAC Address Filter**, select **Enable**.

MAC Filter

You can configure the Zyxel Device to permit access to clients based on their MAC addresses in the **MAC Filter** screen. This applies to wired and wireless connections. Every Ethernet device has a unique MAC (Media Access Control) address. The MAC address is assigned at the factory and consists of six pairs of hexadecimal characters, for example, 00:A0:C5:00:00:02. You need to know the MAC addresses of the LAN client to configure this screen.

MAC Address Filter Enable Disable (Settings are invalid when disable)

MAC Restrict Mode Allow Deny

[+ Add New Rule](#)

Set	Active	Host Name	MAC Address	Delete
<p>Note</p> <p>Enable MAC Address Filter and add the host name and MAC address of a LAN client to the table if you wish to allow or deny them access to your network.</p>				

[Cancel](#)
[Apply](#)

- 2 Click **Add New Rule** to add a new entry. Select **Active**, and then enter the **Host Name** and **MAC Address** of computer B. Click **Apply**.

MAC Address Filter Enable Disable (Settings are invalid when disable)

MAC Restrict Mode Allow Deny

[+ Add New Rule](#)

Set	Active	Host Name	MAC Address	Delete
1	<input checked="" type="checkbox"/>	B	00 - 24 - 21 - AB - 1F - 00	

[Cancel](#) [Apply](#)

5.5 Device Maintenance

This section shows you how to upgrade device firmware, back up the device configuration and restore the device to its previous or default settings.

5.5.1 Backing up the Device Configuration

Back up a configuration file allows you to return to your previous settings.

- 1 Go to the **Maintenance > Backup/Restore** screen.
- 2 Under **Backup Configuration**, click **Backup**. A configuration file is saved to your computer. In this case, the **Backup/Restore** file is saved.

Backup/Restore

Information related to factory default settings and backup configuration are shown in this screen. You can also use this to restore previous device configurations.

Backup Configuration allows you to back up (save) the Zyxel Device's current configuration to a file on your computer. Once your Zyxel Device is configured and functioning properly, it is highly recommended that you back up your configuration file before making configuration changes.

Restore Configuration allows you to upload a new or previously saved configuration file from your computer to your Zyxel Device.

Backup Configuration

Click Backup to save the current configuration of your system to your computer.

Backup

Restore Configuration

To restore a previously saved configuration file to your system, browse to the location of the configuration file and click Upload.

File Path

Back to Factory Default Settings

Click Reset to clear all user-entered configuration information and return to factory default settings. After resetting, the

- Password is printed on a label on the bottom of the device, written after the text "Password".
- LAN IP address will be 192.168.1.1

Do you want to save Backup_Restore (125 KB) from 192.168.1.1?

5.5.2 Restoring the Device Configuration

This section shows you how to restore a previously-saved configuration file from your computer to your Zyxel Device.

- 1 Go to the **Maintenance > Backup/Restore** screen.
- 2 Under **Restore Configuration**, click **Browse/Choose File**, and then select the configuration file that you want to upload. Click **Upload**.

Backup/Restore

Information related to factory default settings and backup configuration are shown in this screen. You can also use this to restore previous device configurations.

Backup Configuration allows you to back up (save) the Zyxel Device's current configuration to a file on your computer. Once your Zyxel Device is configured and functioning properly, it is highly recommended that you back up your configuration file before making configuration changes.

Restore Configuration allows you to upload a new or previously saved configuration file from your computer to your Zyxel Device.

Backup Configuration

Click Backup to save the current configuration of your system to your computer.

Backup

Restore Configuration

To restore a previously saved configuration file to your system, browse to the location of the configuration file and click Upload.

File Path

Back to Factory Default Settings

Click Reset to clear all user-entered configuration information and return to factory default settings. After resetting, the

- Password is printed on a label on the bottom of the device, written after the text "Password".
- LAN IP address will be 192.168.1.1
- DHCP will be reset to default setting

Reset

- 3 The Zyxel Device automatically restarts after the configuration file is successfully uploaded. Wait for one minute before logging into the Zyxel Device again. Go to the **Connection Status** page to check the firmware version after the reboot.

CHAPTER 6

Rover App Tutorials

6.1 Rover App Tutorials Overview

This shows you how to use the Rover app to manage the Zyxel Device and its WiFi network.

The table below explains the terms used in this chapter.

Table 9 Tutorial Term Definition

DEVICE	TERM	ROLE
The Zyxel Device in Router Mode	Rover Router	Router
The Zyxel Device in AP Mode	Rover AP	Access Point
The WRE6605 in AP Mode	WRE6605 AP	Access Point
The WRE6605 in Repeater Mode	WRE6605 Repeater	Repeater

6.2 What You Can Do

- Set up your Rover Router with a repeater (the WRE6605 Repeater as an example) using a wireless connection; see [Section 6.3.1 on page 74](#).
- Set up your Rover AP with a router (Rover Router as an example) using a wired connection; see [Section 6.4.1 on page 75](#).
- Set up your Rover Router with an access point (the WRE6605AP as an example) using a wired connection; see [Section 6.4.2 on page 76](#).
- Use the **Home** screen to see how many devices are connected to your Zyxel Device; see [Section 6.6 on page 78](#).
- Use the **WiFi Settings** screen to configure your general or guest WiFi network; see [Section 6.7 on page 79](#).
- Use the **Devices** screen to view the information of WiFi clients connected to the Zyxel Device; see [Section 6.8 on page 85](#).
- Use the **Parental Control** screen to configure parental control WiFi schedules to block or allow WiFi client device access to the Internet; see [Section 6.9 on page 88](#).
- Use the **Others** screen to run a speed test, view your app version, or log out of the app; see [Section 6.10 on page 90](#).

6.3 WiFi Network Scenario

Connect your Rover Router to a repeater (the WRE6605 Repeater as an example).

6.3.1 Connect the Rover Router to the WRE6605 Repeater

Follow the steps below to set up a Rover Router with a WRE6605 Repeater to extend WiFi range. Connect the Rover Router to the Internet. The Rover Router must be connected to a modem/router using an Ethernet cable.

Table 10 Device Role

DEVICE	TERM	ROLE
Zyxel Device in Router mode	Rover Router	Router
WRE6605 in Repeater mode	WRE6605 Repeater	Repeater







Note: Make sure you reset the Rover Router and WRE6605 to factory defaults before switching to a different mode. Remember to back up your configuration settings before resetting your Zyxel Devices to factory defaults.

- 1 Turn on your modem/router for Internet access. Connect an Ethernet cable from a modem/router to the WAN port on the Rover Router.
- 2 Note the power LEDs on the Rover Router when you're done. The power LEDs should be steady blue. Place the Rover AP where you want WiFi coverage.
- 3 Download the Rover app to your smartphone and log into the WiFi network of the Rover Router. You may need to forget your current WiFi connection on your smartphone.



- 4 Change the default SSID and WiFi key on the Rover Router for better WiFi security; see [Section 6.7.1 on page 80](#) for more information. After applying changes, you will need to reconnect to the Rover Router again using the new SSID and WiFi key.
- 5 Use WPS to copy the SSID and WiFi key from the Rover Router to the WRE6605 Repeater. Press the WPS button on the Rover Router for 1.5 to 4 seconds and then press the WPS button on the WRE6605 Repeater for 2 seconds within 120 seconds.
- 6 Use the Rover app and the table below to see if the repeater is too far from the Rover Router; see [Section 6.8 on page 85](#) for more information.

Table 11 Link Quality

ICON	CONNECTION TYPE	WIFI STATUS
	Wired	Wired Connection
	Wired	Blocked
	Wireless	Good to Go
	Wireless	Too Close to the Router
	Wireless	Weak WiFi
	Wireless	Blocked

6.4 Wired Network Scenarios

- Scenario 1: Connect your Rover AP to a router
- Scenario 2: Connect your Rover Router to an access point

6.4.1 Scenario 1: Connect your Rover AP to the Rover Router

Follow the steps below to set up your Rover AP with a router (the Rover Router as an example). Connect the Rover Router to the Internet. The Rover Router must be connected to a modem/router using an Ethernet cable. Then, connect a LAN port on the Rover AP to a LAN port on the Rover Router using another Ethernet cable.

Table 12 Device Role

DEVICE	TERM	ROLE
Zyxel Device in Router mode	Rover Router	Router
Zyxel Device in AP mode	Rover AP	Access Point

Note: Make sure you reset the Rover Router and Rover AP to factory defaults before switching to a different mode. Remember to back up your configuration setting before resetting your devices to factory defaults.

- 1 Turn on your modem/router for Internet access. Connect an Ethernet cable from a modem/router to the WAN port on the Rover Router.
- 2 Note the power LEDs when you're done. The power LEDs should be steady blue. Place the Rover AP where you want WiFi coverage and connect it to the Rover Router using an Ethernet cable.

- Download the app to your smartphone and log into the Rover Router's WiFi network using the default label information on the back label. You may need to forget your current WiFi connection on your smartphone.



- Change the default SSID and WiFi key on the Rover Router for better WiFi security; see [Section 6.7.1 on page 80](#) for more information. After applying changes, you will need to reconnect to Rover Router again using the new SSID and WiFi key.
- Use WPS to copy the SSID and WiFi key from the Rover Router to the Rover AP. Press the WPS button on the Rover Router for 1.5 to 4 seconds and then press the WPS button on the Rover AP until the LED blinks in purple within 120 seconds.
- Use the Rover app and the table below to see if the access point is securely connected to the Rover Router; see [Section 6.8 on page 85](#) for more information.

Table 13 Link Quality

ICON	CONNECTION TYPE	WIFI STATUS
	Wired	Wired Connection
	Wired	Blocked
	Wireless	Good to Go
	Wireless	Too Close to the Router
	Wireless	Weak WiFi
	Wireless	Blocked

6.4.2 Scenario 2: Connect the Rover Router to the WRE6605 AP

Follow the steps below to set up the Rover Router with an access point (the WRE6605AP as an example). Connect the Rover Router to the Internet. The Rover Router must be connected to a modem/router

using an Ethernet cable. Then, connect the LAN port on the WRE6605AP to a LAN port on the Rover Router using another Ethernet cable.

Table 14 Device Role

DEVICE	TERM	ROLE
Zyxel Device in Router mode	Rover Router	Router
WRE6605 in AP mode	WRE6605 AP	Access Point





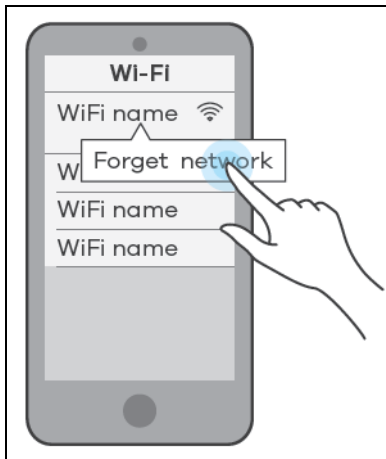

Note: Make sure you reset the Zyxel Device and WRE6605 to factory defaults before switching to a different mode. Remember to back up your configuration setting before resetting your devices to factory defaults.

- 1 Turn on your modem/router for Internet access. Connect an Ethernet cable from a modem/router to the WAN port on the Rover Router.
- 2 Note the power LEDs when you're done. The power LEDs should be steady blue. Place the WRE6605 AP where you want WiFi coverage and connect it to the Rover Router using an Ethernet cable.
- 3 Download the Rover app to your smartphone and log into Rover Router's WiFi network using the default label information on the back label. You may need to forget your current WiFi connection on your smartphone.



- 4 Change the default SSID and WiFi key on the Rover Router for better WiFi security; see [Section 6.7.1 on page 80](#) for more information. After applying changes, you will need to reconnect to the Rover Router again using the new SSID and WiFi key.
- 5 Use WPS to copy the SSID and WiFi key from the Rover Router to the WRE6605 AP. Press the WPS button on the Rover Router for 1.5 to 4 seconds and then press the WPS button for 2 seconds on the WRE6605 AP within 120 seconds.
- 6 Use the Rover app and the table below to see if the access point is securely connected to the Rover Router; see [Section 6.8 on page 85](#) for more information.

Table 15 Link Quality

ICON	CONNECTION TYPE	WIFI STATUS
	Wired	Wired Connection
	Wired	Blocked
	Wireless	Good to Go
	Wireless	Too Close to the Router
	Wireless	Weak WiFi
	Wireless	Blocked

6.5 Network Management with the Rover App

You can use the Rover app to view WiFi connection status of your device, configure general and guest WiFi settings, add a parental control profile, and run a speed test. See the following sections for more information.

- [Home Settings](#)
- [General WiFi and Guest Settings](#)
- [Devices Settings](#)
- [Parental Control Settings](#)
- [Others Settings](#)

6.6 Home Settings

Tap on the **Home** icon () in the navigation panel. The **Home** screen displays and shows the number of the devices connected to the Zyxel Device.

You can tap **Connected Device** in the **Home** screen to go to the **Devices** screen. See [Section 6.8 on page 85](#) for more device information.

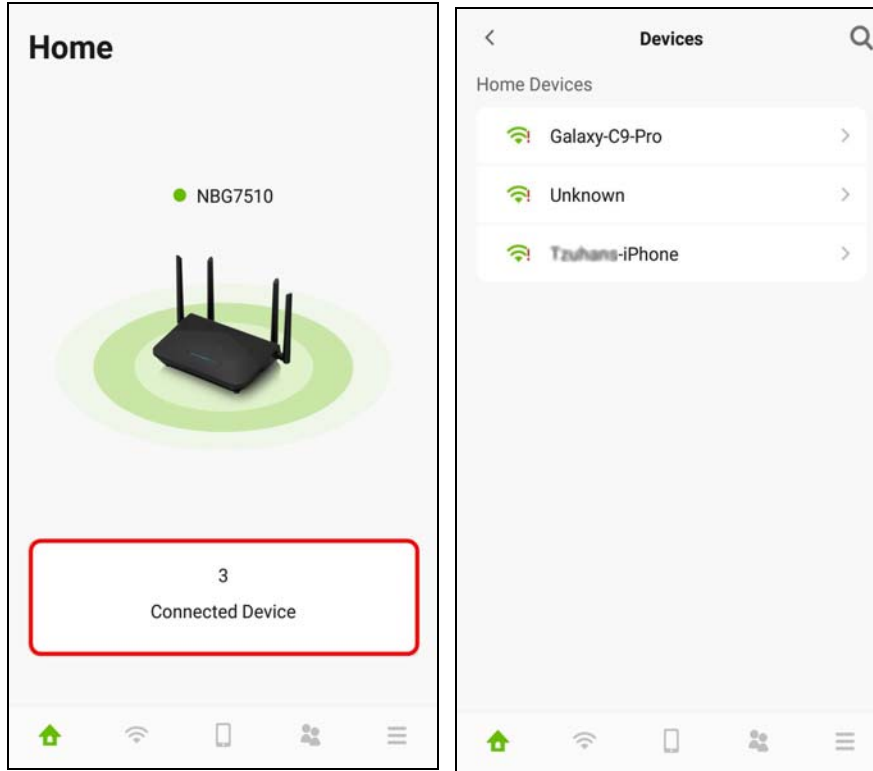

6.7 General WiFi and Guest Settings

Use this screen to configure settings for your main WiFi and guest network.

You can set up a guest WiFi network for your Zyxel Device. Company A wants to create a different WiFi network group for different types of users as shown in the following figure. This group has its own SSID and password.

- Employees in Company A will use a general Company WiFi network group.
- Visiting guests will use the Guest WiFi network group, which has a different SSID and password. Visiting guests cannot connect to the company network using guest WiFi.

Figure 39 General and Guest WiFi Network Example

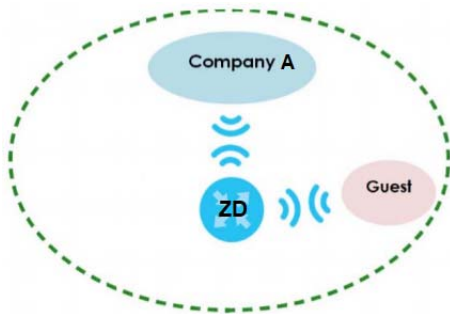
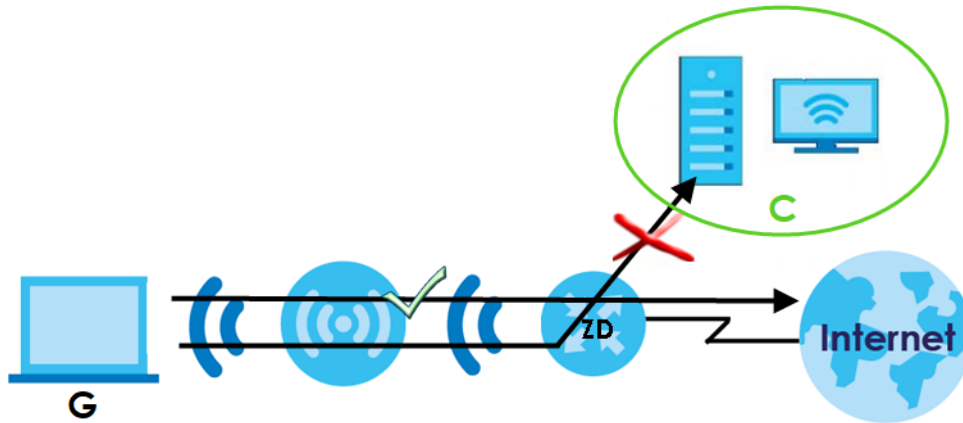

Figure 40 Visiting Guests Blocked from Company Network





6.7.1 Setting Up General WiFi Settings

Follow the steps below to configure your general WiFi settings. Use the parameters in the table below to create a set of **WiFi Name** and **Password**.

Table 16 The General WiFi Settings Parameters Example

GENERAL WIFI	
WiFi Name	Company
Password	company123

- 1 Tap on the **WiFi** icon () in the navigation panel. The **WiFi > Home** screen displays. Tap on the () icon to edit your general **WiFi Name** and **WiFi Password**. In this example, enter **Company** as your general **WiFi Name** and **company123** as your general **WiFi Password**. Click **Save** to save the changes.

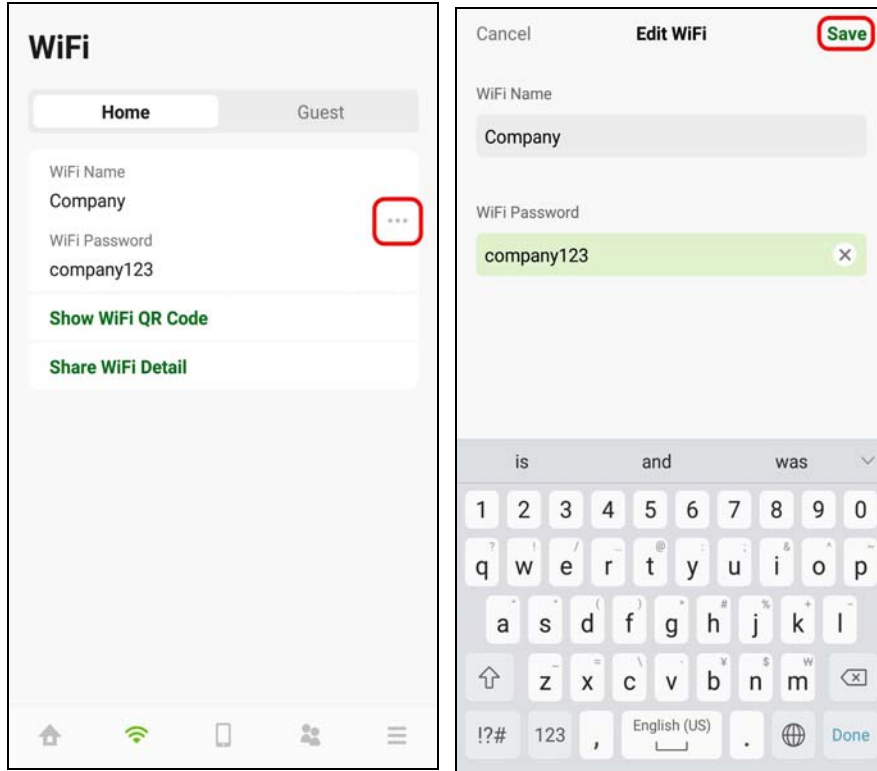

- 2 You can use the app to create a QR code with your WiFi network name and password. Tap **Show WiFi QR Code** in the **WiFi > Home** screen, the QR code will display as shown. Use a smartphone to scan the QR code to join the general WiFi network. By printing and placing the QR code somewhere accessible, you can let your friends or guests scan the QR code and join the WiFi network directly without revealing your actual WiFi password.

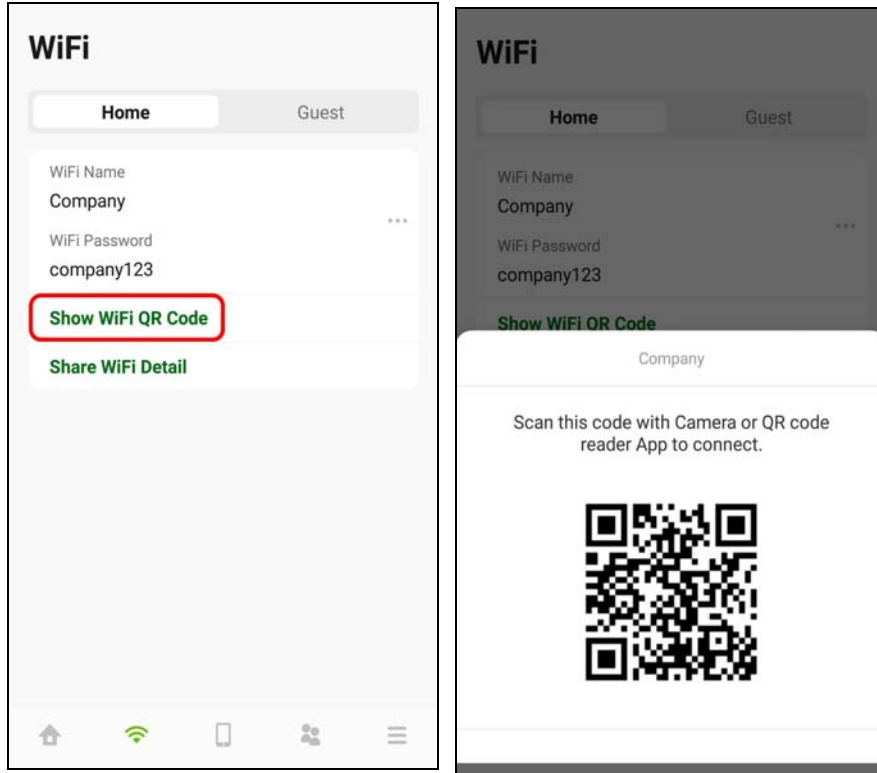

- 3 Tap **Share WiFi Detail** in the **WiFi > Home** screen. To share your general WiFi name and password with your friends, select a media, such as Gmail or Skype, to send connection info to your friends.

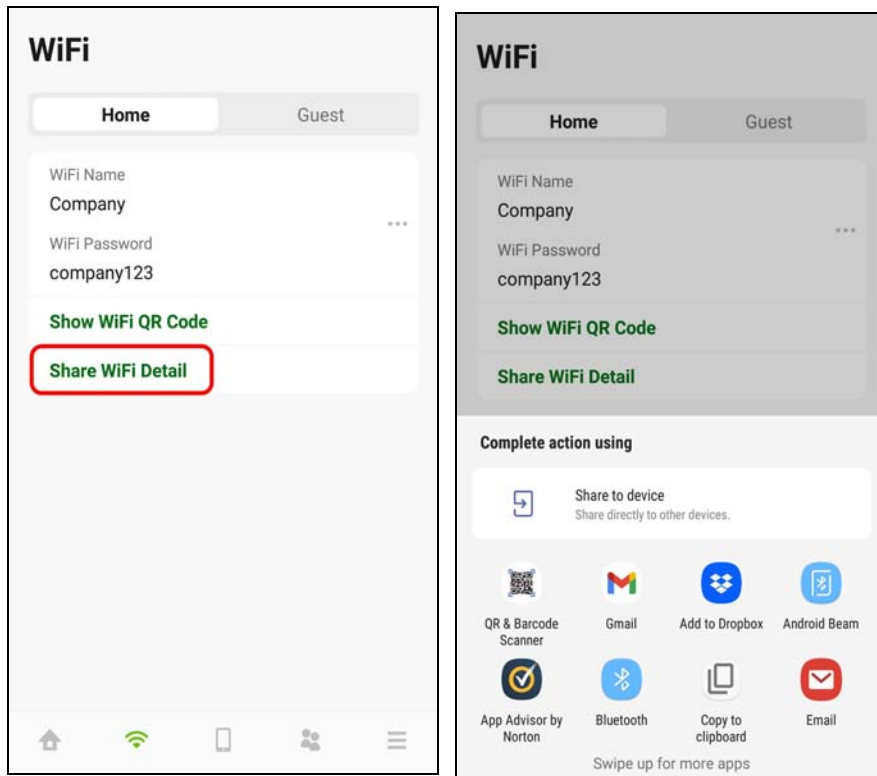

6.7.2 Setting Up Guest WiFi Settings

Follow the steps below to configure your guest WiFi settings. Use the parameters in the table below to create a different set of WiFi name and password.

Table 17 The Guest WiFi Settings Parameters Example

GUEST WIFI	
WiFi Name	Guest
WiFi Password	guest123

Tap on the **Guest** tab and then the **WiFi > Guest** screen appears. Click the switch to enable **Guest WiFi**. When the switch goes to the right, **Guest WiFi** is enabled. Tap on the (**...**) icon to edit the guest **WiFi Name** and **WiFi Password**. In this example, enter **Guest** as your guest **WiFi Name** and **guest123** as your guest **WiFi Password**. Click **Save** to save the changes.

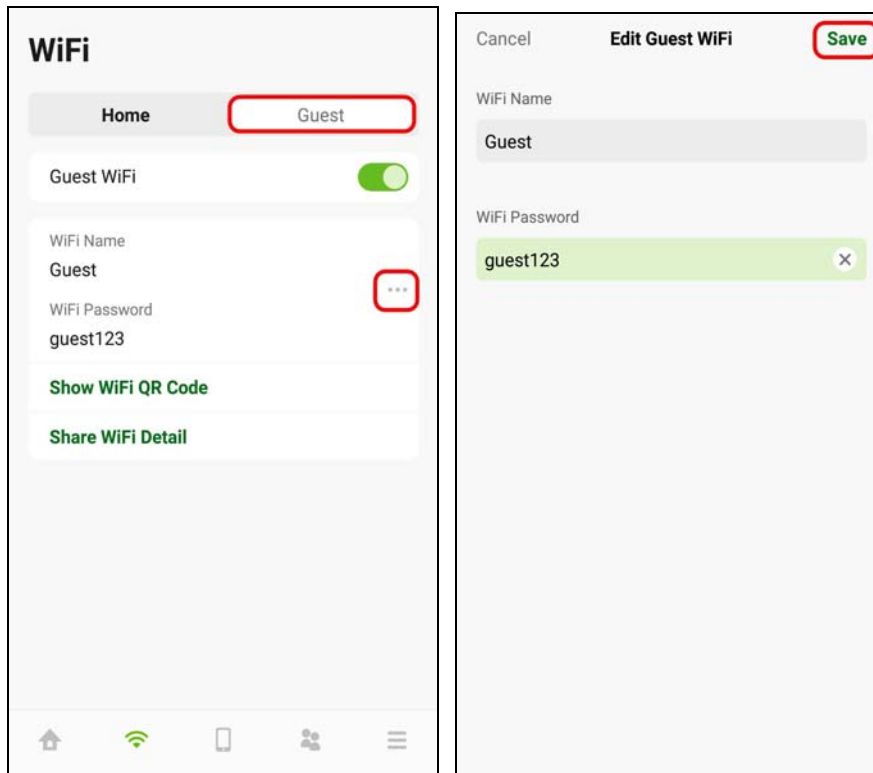

- 4 You can use the app to create a QR code with your WiFi network name and password. Click **Show WiFi QR Code** in the **WiFi > Guest** screen, the QR code will display as shown. Use a smartphone to scan the QR code to join the guest WiFi network. By printing and placing the QR code somewhere accessible, you can let your friends or guests scan the QR code and join the WiFi network directly without revealing your actual WiFi password.

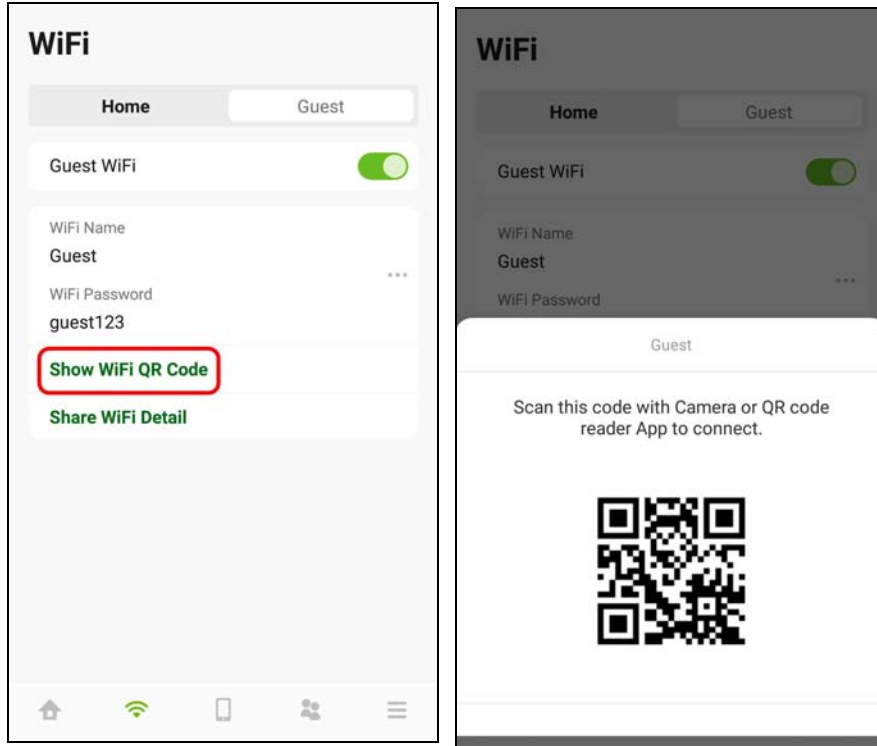

- 5 Tap **Share WiFi Detail** in the **WiFi > Guest** screen. To share your guest WiFi name and password with your friends, select a media, such as Gmail or Skype, to send connection info to your friends.

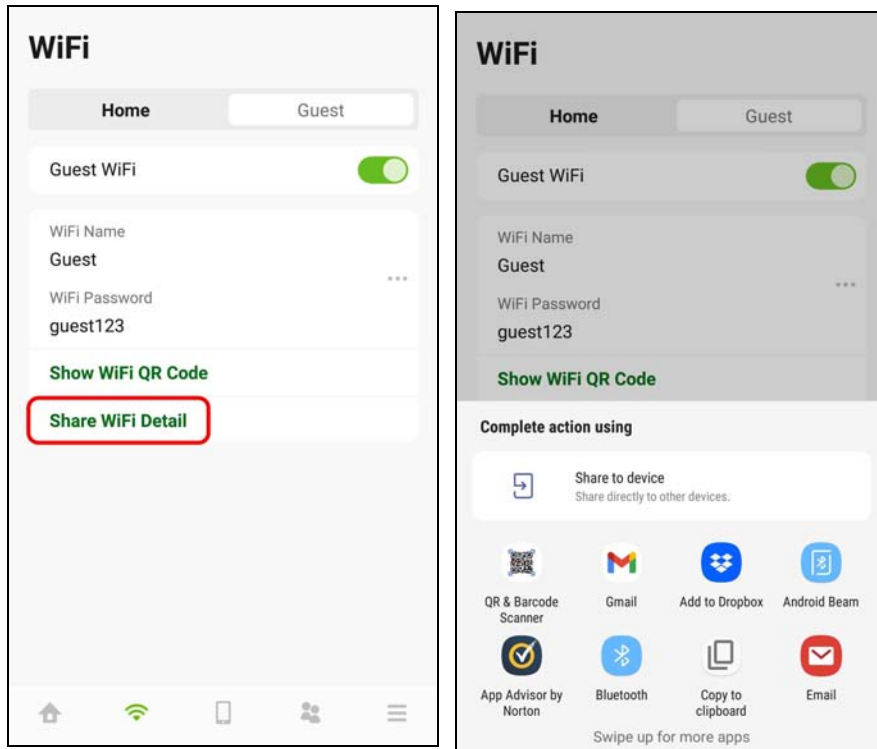

6.8 Devices Settings

- 1 Tap on the **Devices** icon () in the navigation panel. Use the **Devices** screen to view the devices connected to the Zyxel Device. Tap on the Arrow icon () next the device name you want to see. In this example, tap on the Arrow icon () next to the **Galaxy-C9-Pro**. The **Galaxy-C9-Pro** screen displays.

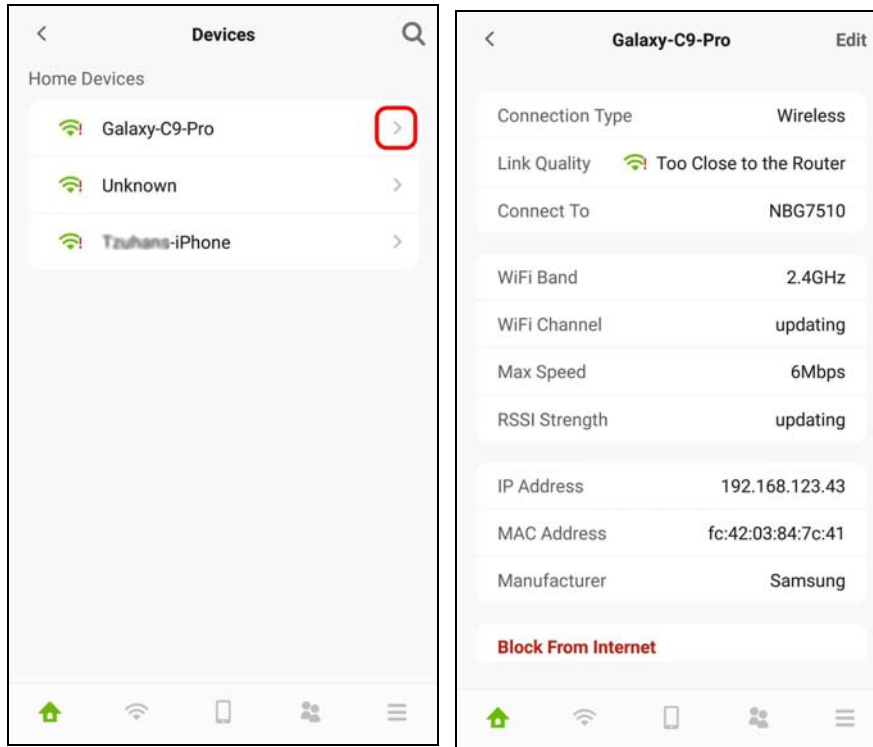

- 2 After you place your access point or repeater connected to the Zyxel Device, use the **Devices** screen and the table below to check WiFi connection status.

Table 18 Link Quality







ICON	CONNECTION TYPE	WIFI STATUS
	Wired	Wired Connection
	Wired	Blocked
	Wireless	Good to Go
	Wireless	Too Close to the Router
	Wireless	Weak WiFi
	Wireless	Blocked

Table 19 WiFi Connection Status

WIFI CONNECTION STATUS	ACTION
Too Close to the Router	Move the client device farther away from the Zyxel Device.
Weak WiFi	Move the client device closer to the Zyxel Device.

Move your Galaxy-C9-Pro farther away from your Zyxel Device as the WiFi status is **Too Close to the Router**.

- 3 To quickly block a client device from accessing your WiFi network, click **Block From Internet**. In this example, click **Block from Internet** in the **Galaxy-C9-Pro** screen. Click **Block** to save the changes.

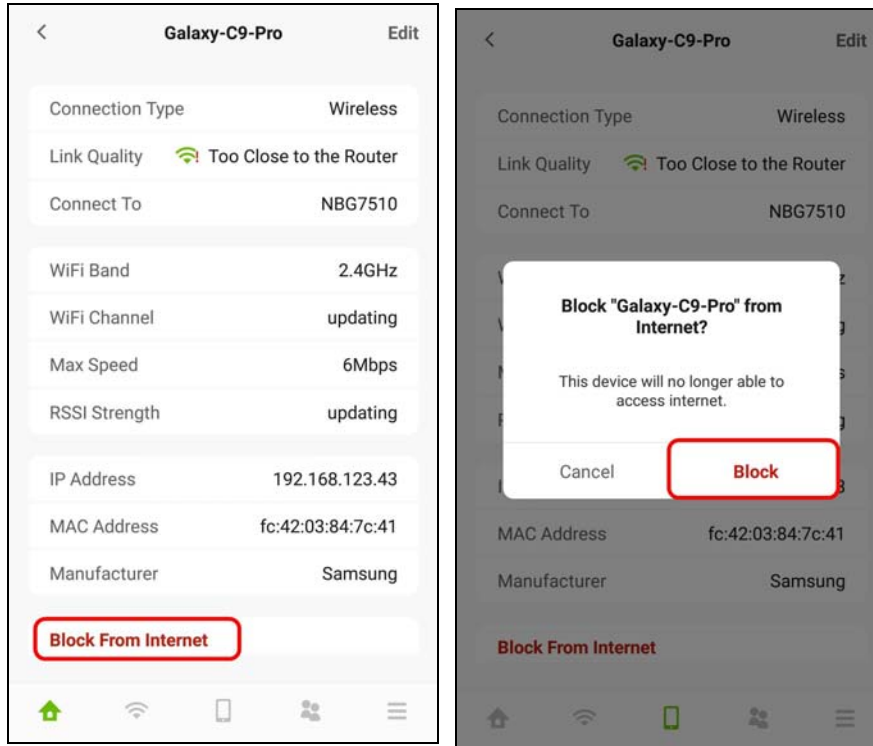

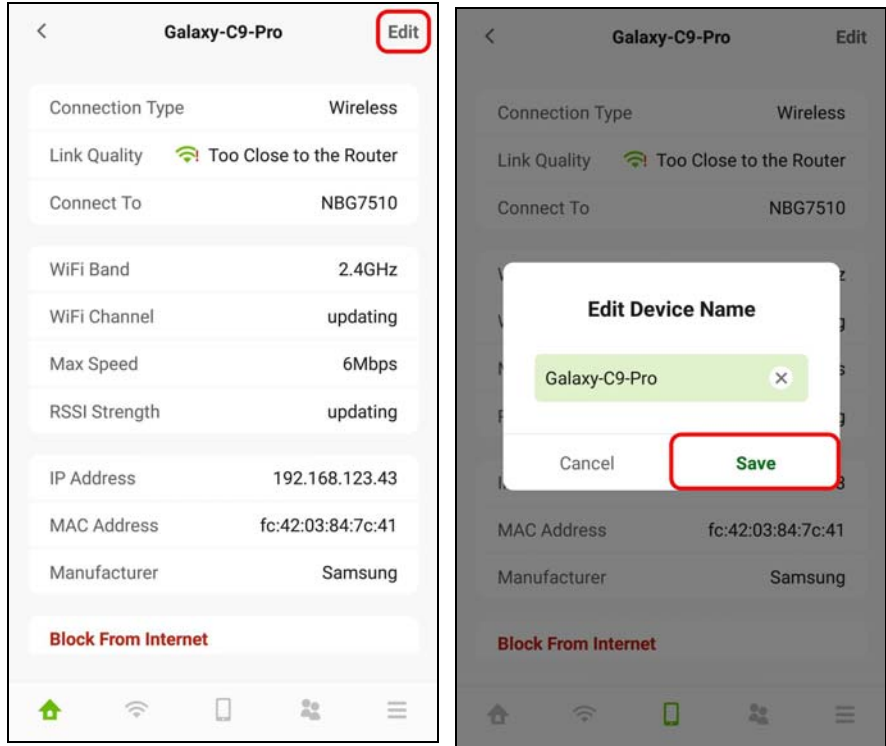

- 4 Click **Edit** if you want to modify your device name. Enter your device name and then click **Save** to save the changes.

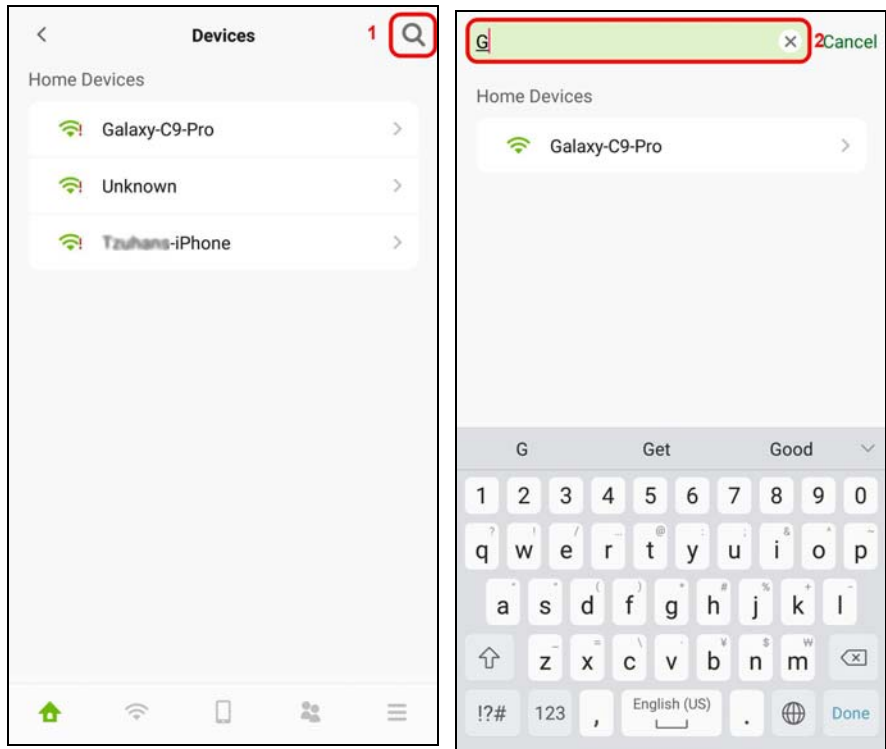

- 5 To look for a specific device, tap on the Search icon (🔍) in the **Devices** screen. Enter keywords to look for a device. Tap **Cancel** if you want to go back to the previous screen.



6.9 Parental Control Settings

- 1 Parental Control allows you to create and repeat a weekly schedule to restrict Internet usage for users. Tap on the **Parental Control** icon (). The **Parental Control** screen displays. Tap **Create Profile** (only appears at the first time) or the **Add** icon () to create a new parental control profile. The **New Profile** screen appears as shown.

The following example shows you how to create a studying schedule and block users from accessing the Internet for a certain period of time. Use the parameter below to create a profile. Tap **Create Profile** and then the **New Profile** screen appears. Enter Studying Schedule as the profile name.

Table 20 Parental Control Settings Parameters Example

PROFILE NAME	START TIME	END TIME	REPEAT ON
Studying Schedule	8:00 am	11:00 am	from Monday to Friday

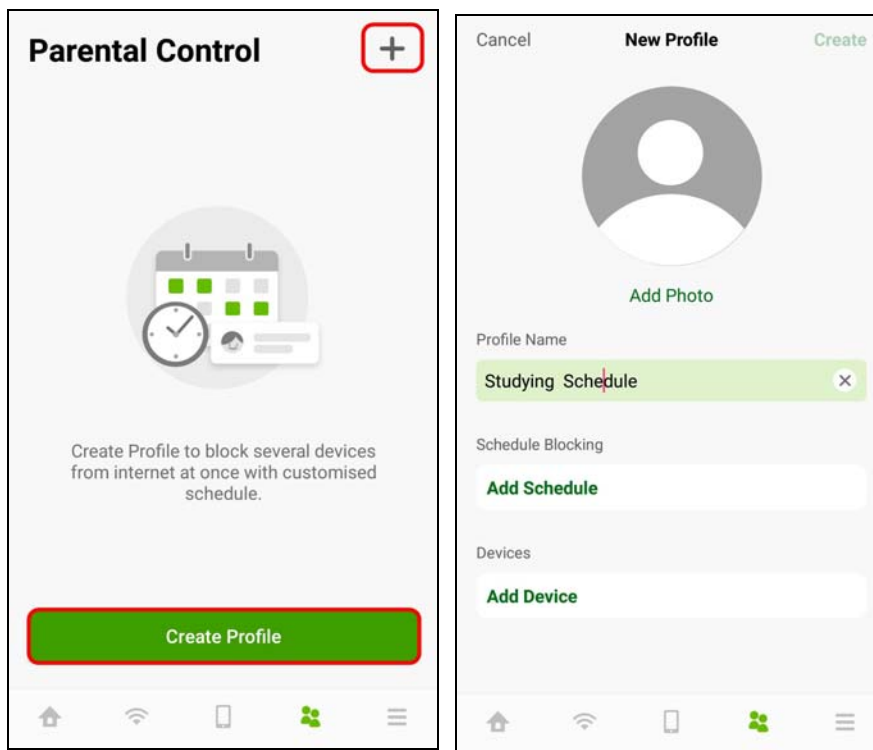

- 2 Click **Add Schedule** on the **Studying Schedule** screen to create a schedule. The **Add Schedule** screen displays. Select the day(s) of the week to repeat the rule and then enter the **Start Time** and **End Time** in the **Add Schedule** screen. In this example, select from Monday to Friday. Then, enter 8:00 as **Start Time**, and 11:00 as **End Time**.
Click **Add Device** to apply the **Studying Schedule** profile to a device. The **Add Device** screen appears as shown. Select the device you want to add and then click **Add** to save the changes.

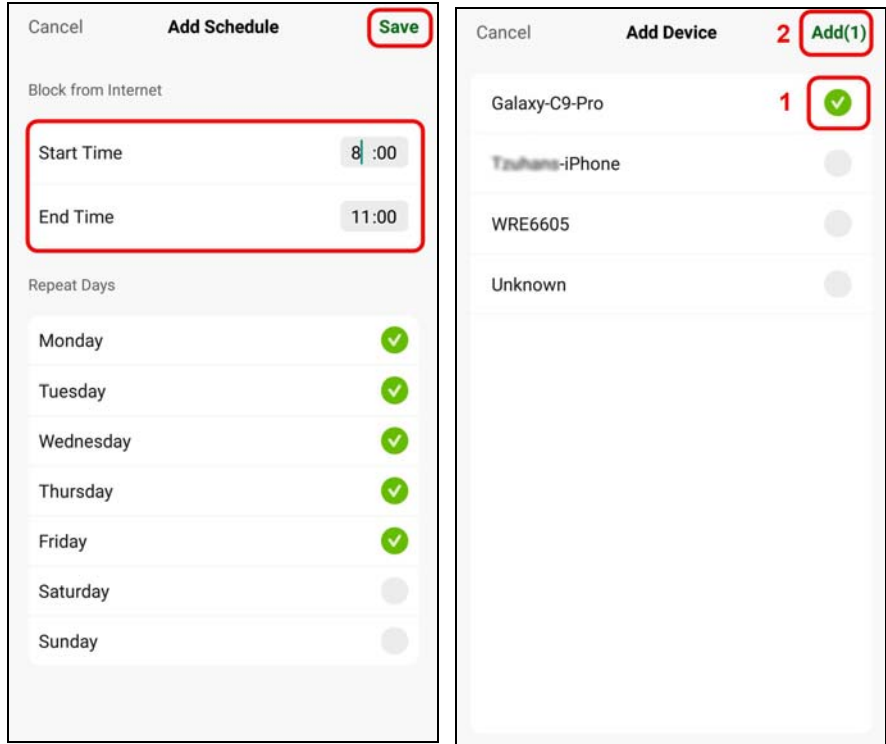

- 3 Tap on the Arrow icon (>) next to the profile to go back and continue modifying your profile. In this example, click the Arrow icon (>) next to Studying Schedule. The **Studying Schedule** screen will appear.

Click **Edit** if you want to modify the name of the profile. Click the switch to enable or disable this WiFi schedule profile. Click the (...) icon if you want to edit the parental control schedule or apply this profile to another device. Click **Delete Profile** to remove this profile.

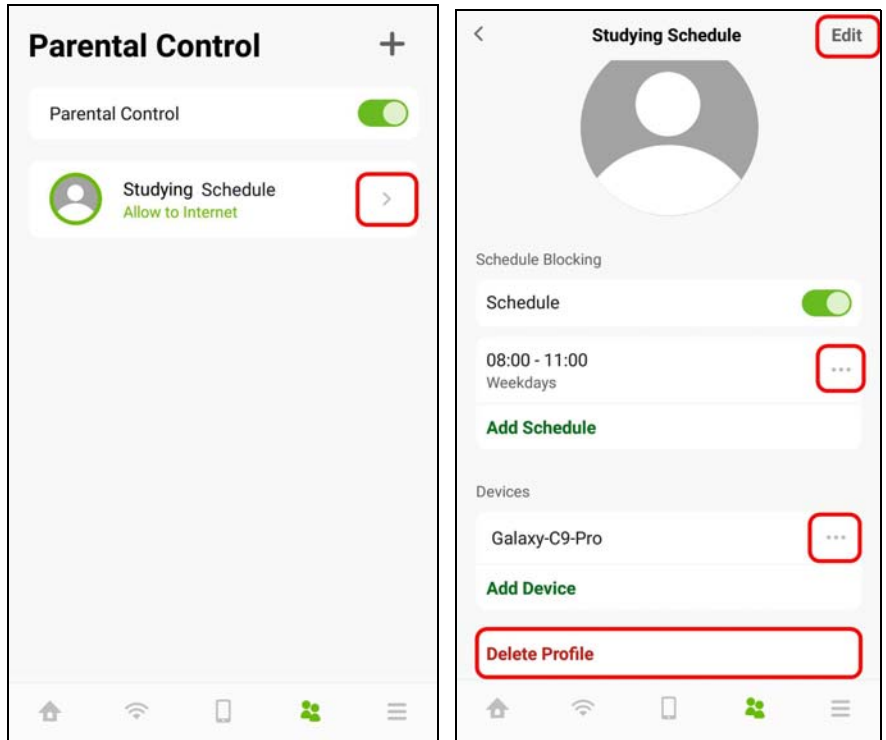

6.10 Others Settings

- 1 Tap on the **Others** icon (☰) in the navigation panel. The **Others** screen appears. Click **Speed Test** if you want to conduct a speed test for downstream and upstream data rates. The **Speed Test** screen appears. Click **Start** to perform a test.

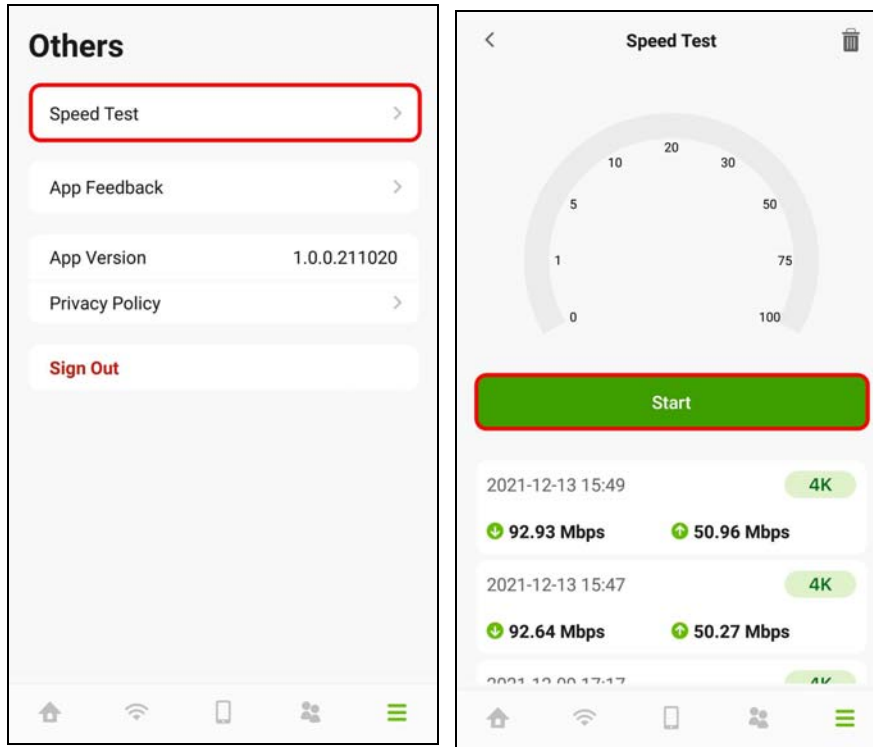

- 2 Click the Delete icon (🗑️) if you want to remove all previous test results. Click **Delete** to confirm the changes.

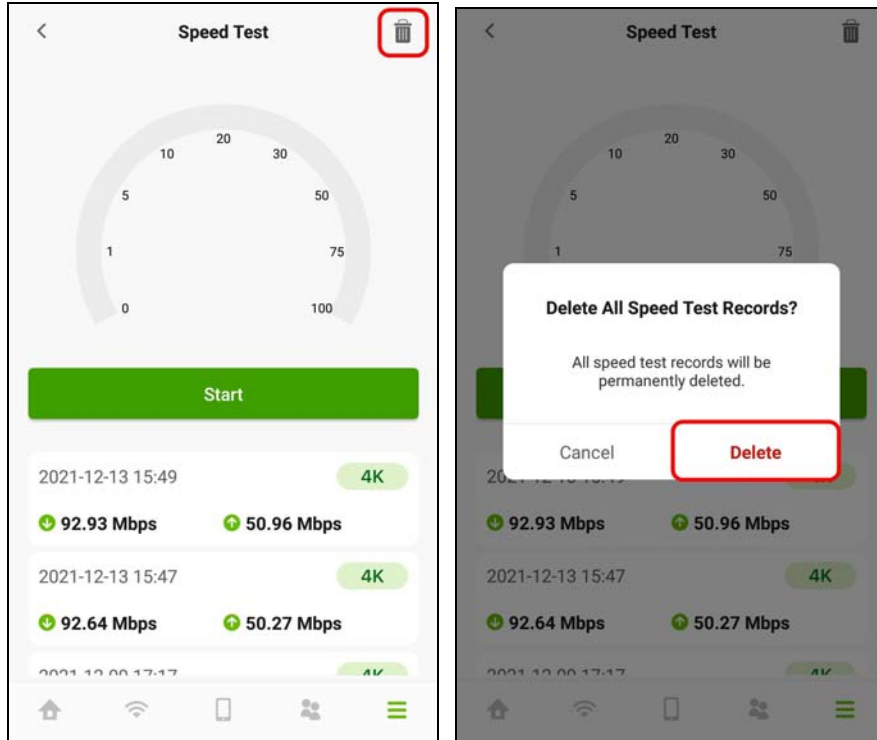

3 You can also use this screen to do the following:

- Give us feedback.
- View the app version.
- View the privacy policy.
- Log out of the app.

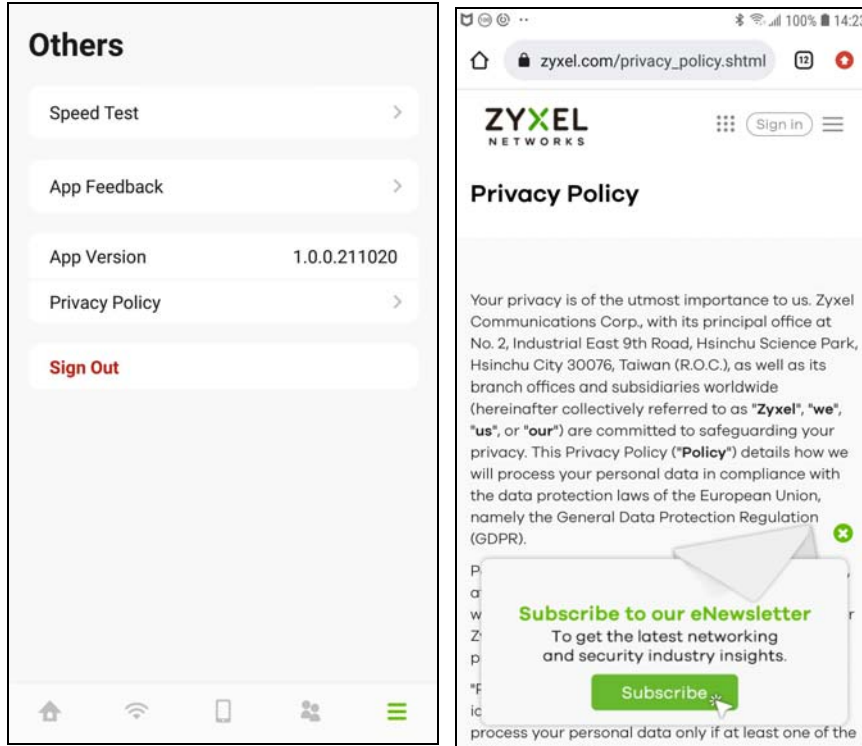

PART II

Technical Reference

CHAPTER 7

Connection Status

7.1 Connection Status Overview

After you log into the Web Configurator, the **Connection Status** screen appears. You can configure basic Internet access and WiFi settings in this screen. It also shows the network status of the Zyxel Device and computers or devices connected to it.

7.1.1 Connectivity

Use this screen to view the network connection status of the Zyxel Device and its clients.

Figure 41 Connectivity

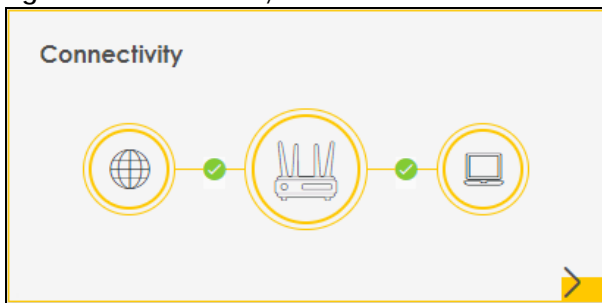

Click the Arrow icon (➤) to view IP addresses and MAC addresses of the wireless and wired devices connected to the Zyxel Device.

Figure 42 Connectivity: Connected Devices

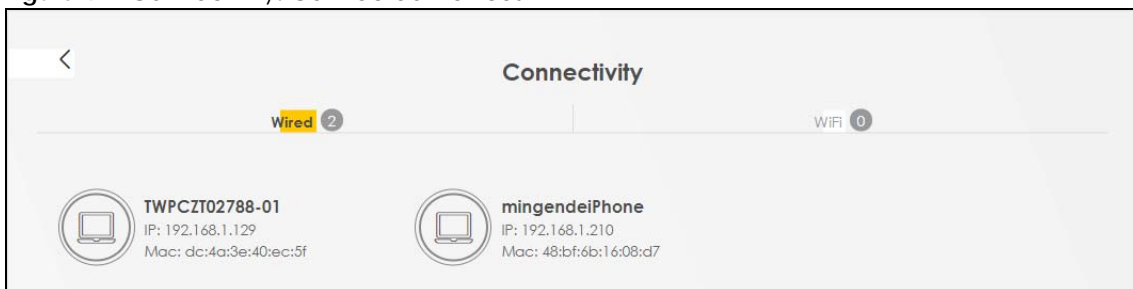

You can change the icon and name of a connected device. Place your mouse within the device block, and an Edit icon (✎) will appear. Click the Edit icon, and you'll see there are several icon choices for you to select. Enter a name in the **Device Name** field for a connected device. Click to enable (☑) **Internet Blocking** for a connected WiFi client. Click **Save** to save your changes.

7.1.2 Icon and Device Name

Select an icon and/or enter a name in the **Device Name** field for a connected device. Click to enable

() **Internet Blocking** (or **Active**) for a connected WiFi client. Click **Save** to save your changes.

Figure 43 Connectivity: Edit



7.1.3 System Info

Use this screen to view the basic system information of the Zyxel Device.

Figure 44 System Info

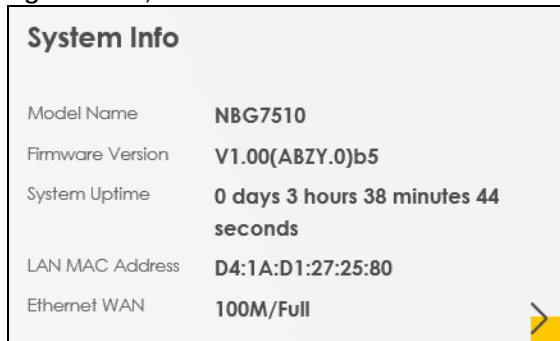

Click the Arrow icon () to view more information on the status of your firewall and interfaces (WAN, LAN, and WLAN).

Figure 45 System Info: Detailed Information

System Info

Host Name: NBG7510
 Model Name: NBG7510
 Serial Number: S210Y45016855
 Firmware Version: V1.00[ABZY.0])b5
 System Uptime: 0 days 3 hours 39 minutes 57 seconds
 Interface Up Time: 0 days 3 hours 38 minutes 23 seconds
 CPU Usage: 0%
 Memory Usage: 47.6%

Interface Status

LAN1 LAN2 LAN3 WAN WLAN 2.4G WLAN 5G
 1000M/Full - - 100M/Full 573 Mbps 1201 Mbps

WAN Information (Ethernet WAN)

Name	ETHWAN
Encapsulation	IPoE
IP Address	10.214.35.39 Release
IP Subnet Mask	255.255.255.0
IPv6 Address	N/A
MAC Address	D4:1A:D1:27:25:83
Primary DNS server	8.8.8.8
Secondary DNS server	168.95.1.1

LAN Information

IP Address	192.168.123.1
Subnet Mask	255.255.255.0
IPv6 Address	N/A
IPv6 Link Local Address	fe80::d61a:d1ff:fe27:2580
DHCP	Server
MAC Address	D4:1A:D1:27:25:80

Security

Firewall	Medium
----------	--------

WLAN Information

	2.4GHz	5GHz
MAC Address	D4:1A:D1:27:25:81	D4:1A:D1:27:25:82
Status	On	On
SSID	Zyxel_2581	Zyxel_2581
Channel	Auto(Current 3)	Auto(Current 36)
Security	WPA3-Personal-Transition	WPA3-Personal-Transition
802.11 Mode	802.11b/g/n/ax Mixed	802.11a/n/ac/ax Mixed
WPS	On	On

Each field is described in the following table.

Table 21 System Info: Detailed Information

LABEL	DESCRIPTION
Host Name	This field displays the ZyXel Device system name. It is used for identification.
Model Name	This shows the model number of your ZyXel Device.
Serial Number	This field displays the serial number of the ZyXel Device.
Firmware Version	This is the current version of the firmware inside the ZyXel Device.
System Uptime	This field displays how long the ZyXel Device has been running since it last started up. The ZyXel Device starts up when you plug it in, when you restart it (Maintenance > Reboot), or when you reset it.
CPU Usage	This displays the current CPU usage percentage.
Memory Usage	This displays the current RAM usage percentage.

Table 21 System Info: Detailed Information (continued)

LABEL	DESCRIPTION
WAN Information (These fields display when you have an Ethernet WAN connection.)	
IP Subnet Mask	This field displays the current subnet mask in the WAN.
Primary DNS server	This field displays the first DNS server address assigned by the ISP.
Secondary DNS server	This field displays the second DNS server address assigned by the ISP.
Primary DNSv6 server	This field displays the first DNS server IPv6 address assigned by the ISP.
Secondary DNSv6 server	This field displays the second DNS server IPv6 address assigned by the ISP.
LAN Information	
IP Address	This is the current IP address of the Zyxel Device in the LAN.
Subnet Mask	This is the current subnet mask in the LAN.
IPv6 Address	This is the current IPv6 address of the Zyxel Device in the LAN.
IPv6 Link Local Address	This field displays the current link-local address of the Zyxel Device for the LAN interface. A link-local address is a special type of the IP address that is therefore only valid for communication within the local network segment or broadcast domain of the device. Typically, link-local addresses are used for automatic address configuration and neighbor discovery protocols.
DHCP	This field displays what DHCP services the Zyxel Device is providing to the LAN. The possible values are: Server – The Zyxel Device is a DHCP server in the LAN. It assigns IP addresses to other computers in the LAN. Relay – The Zyxel Device acts as a surrogate DHCP server and relays DHCP requests and responses between the remote server and the clients. None – The Zyxel Device is not providing any DHCP services to the LAN.
MAC Address	This shows the network adapter MAC (Media Access Control) Address of the LAN interface.
Security	
Firewall	This displays the firewall's current security level (High, Medium, Low, or Disabled).
WLAN Information	
MAC Address	This shows the WiFi adapter MAC (Media Access Control) Address of the WiFi interface.
Status	This displays whether the WLAN is activated.
SSID	This is the descriptive name used to identify the Zyxel Device in a WLAN.
Channel	This is the channel number currently used by the WiFi interface.
Security	This displays the type of security mode the WiFi interface is using in the WLAN.
802.11 Mode	This displays the type of 802.11 mode the WiFi interface is using in the WLAN.
WPS	This displays whether WPS is activated on the WiFi interface.

7.1.4 WiFi Settings



Use this screen to enable or disable the main WiFi network. When the switch turns blue () , the function is enabled. You can use this screen or the QR code on the upper right corner to check the SSIDs (WiFi network name) and passwords of the main WiFi networks. If you want to show or hide your WiFi passwords, click the Eye icon ().

Figure 46 WiFi Settings



Click the Arrow icon (➔) to configure the SSIDs and/or passwords for your main WiFi networks. Click the Eye icon (👁) to display the characters as you enter the WiFi Password.

Scanning the QR code is an alternative way to connect your WiFi client to the WiFi network.

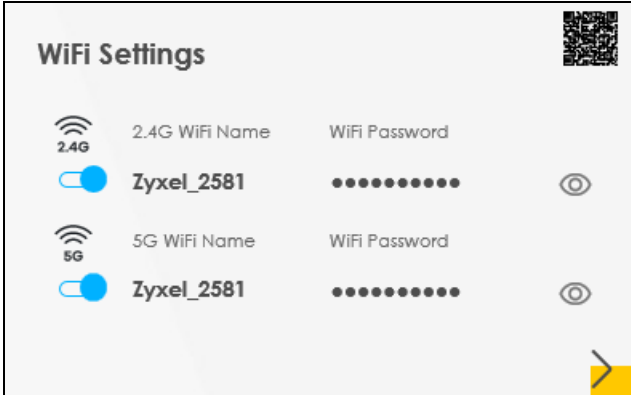
Select **Smart Connect** to use the same SSID for 2.4 GHz and 5 GHz bands.

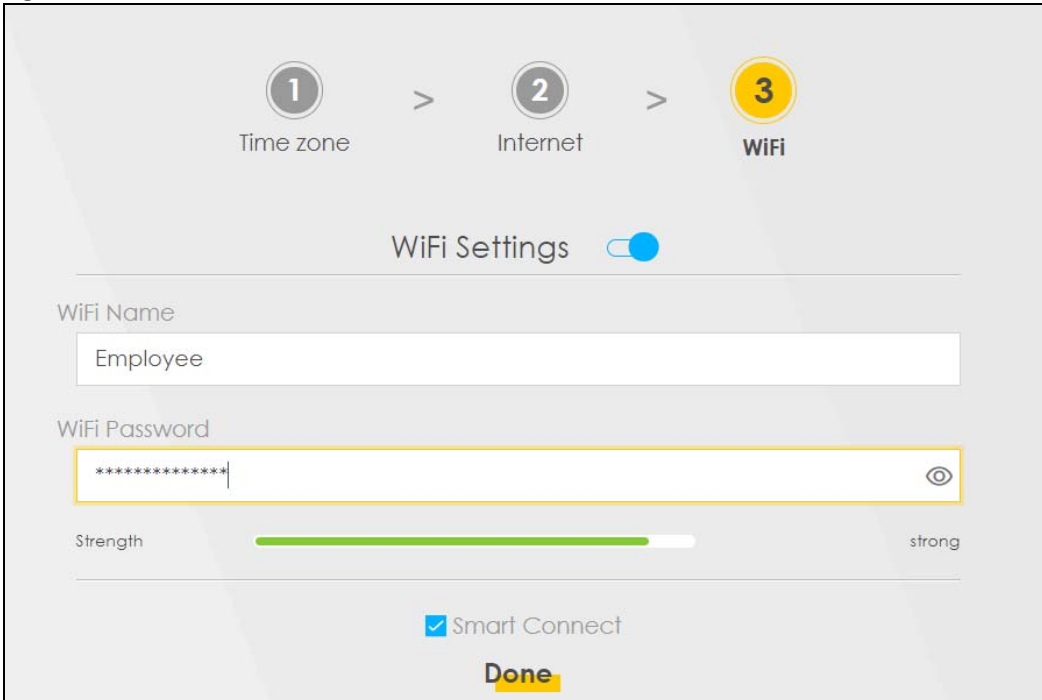

Note: Note that you have to disable Zyxel MESH in the **Network Setting > Wireless > Mesh** screen to deselect the **Smart Connect** check box.

Figure 47 WiFi Settings: Configuration



Each field is described in the following table.

Table 22 WiFi Settings: Configuration

LABEL	DESCRIPTION
Smart Connect	Select this and the 2.4 GHz and 5 GHz WiFi networks will use the same SSID. If you deselect this, the screen will change. You need to assign different SSIDs for the 2.4 GHz and 5 GHz WiFi networks.
2.4 GHz / 5 GHz WiFi	Click this switch to enable or disable the 2.4G / 5G WiFi network. When the switch turns blue  , the function is enabled.
WiFi Name	The SSID (Service Set IDentity) identifies the service set with which a wireless device is associated. Wireless devices associating to the access point (AP) must have the same SSID. Enter a descriptive name (up to 32 English keyboard characters) for the WiFi.
WiFi Password	If you selected Random Password , this field displays a pre-shared key generated by the Zyxel Device. If you did not select Random Password , you can manually type a pre-shared key from 8 to 64 case-sensitive keyboard characters. Click the Eye icon to show or hide the password for your WiFi network. When the Eye icon is slashed  , you will see the password in plain text. Otherwise, it is hidden.
Random Password	Select this to have the Zyxel Device automatically generate a password. The WiFi Password field will not be configurable when you select this option.
Hide WiFi network name	Select this to hide the SSID in the outgoing beacon frame so a station cannot obtain the SSID through scanning using a site survey tool. Note: Disable WPS in the Network Setting > Wireless > WPS screen to hide the SSID.
Save	Click Save to save your changes.

7.2 Guest WiFi Settings

Use this screen to enable or disable the guest 2.4 GHz and/or 5 GHz WiFi networks. When the switch goes to the right () , the function is enabled. Otherwise, it is not. You can check their SSIDs (WiFi network name) and passwords from this screen. If you want to show or hide your WiFi passwords, click the Eye icon.

Figure 48 Guest WiFi Settings



Click the Arrow icon () to open the following screen. Use this screen configure the SSIDs and/or passwords for your guest WiFi networks.

Figure 49 Guest WiFi Settings: Configuration

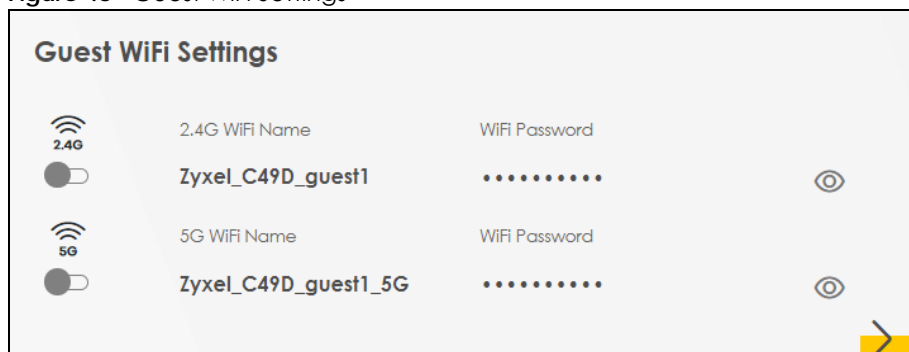
To assign different SSIDs to the 2.4 GHz and 5 GHz guest WiFi networks, clear the **Smart Connect** check box in the **WiFi Settings** screen, and the **Guest WiFi Settings** screen will change.

Note: Note that you have to disable Zyxel MESH in the **Network Setting > Wireless > Mesh** screen to clear the **Smart Connect** check box.

Figure 50 Guest WiFi Settings: Different SSIDs

Each field is described in the following table.

Table 23 WiFi Settings: Configuration



LABEL	DESCRIPTION
2.4G/5G WiFi	Click this switch to enable or disable the 2.4 GHz and/or 5 GHz WiFi networks. When the switch goes to the right  , the function is enabled. Otherwise, it is not.
WiFi Name	The SSID (Service Set IDentity) identifies the service set with which a wireless device is associated. Wireless devices associating to the access point (AP) must have the same SSID. Enter a descriptive name (up to 32 English keyboard characters) for the WiFi.

Table 23 WiFi Settings: Configuration (continued)

LABEL	DESCRIPTION
WiFi Password	If you selected Random Password , this field displays a pre-shared key generated by the Zyxel Device. If you did not select Random Password , you can manually type a pre-shared key from 8 to 64 case-sensitive keyboard characters.
	Click the Eye icon to show or hide the password of your WiFi network. When the Eye icon is slashed  , you will see the password in plain text. Otherwise, it is hidden.
Random Password	Select this option to have the Zyxel Device automatically generate a password. The WiFi Password field will not be configurable when you select this option.
Hide WiFi network name	Select this check box to hide the SSID in the outgoing beacon frame so a station cannot obtain the SSID through scanning using a site survey tool. Note: Disable WPS in the Network Setting > Wireless > WPS screen to hide the SSID.
Save	Click Save to save your changes.

7.2.1 LAN

Use this screen to view the LAN IP address, subnet mask, and DHCP settings of your Zyxel Device. Click the switch button to turn on/off the DHCP server.

Figure 51 LAN

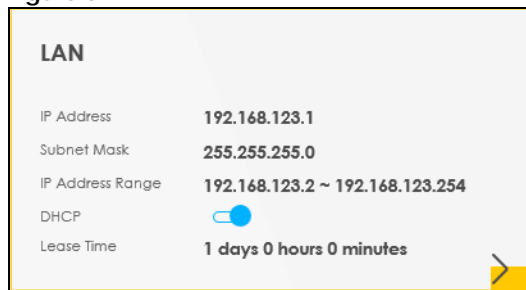

Click the Arrow icon () to configure the LAN IP settings and DHCP setting for your Zyxel Device.

Figure 52 LAN Setup

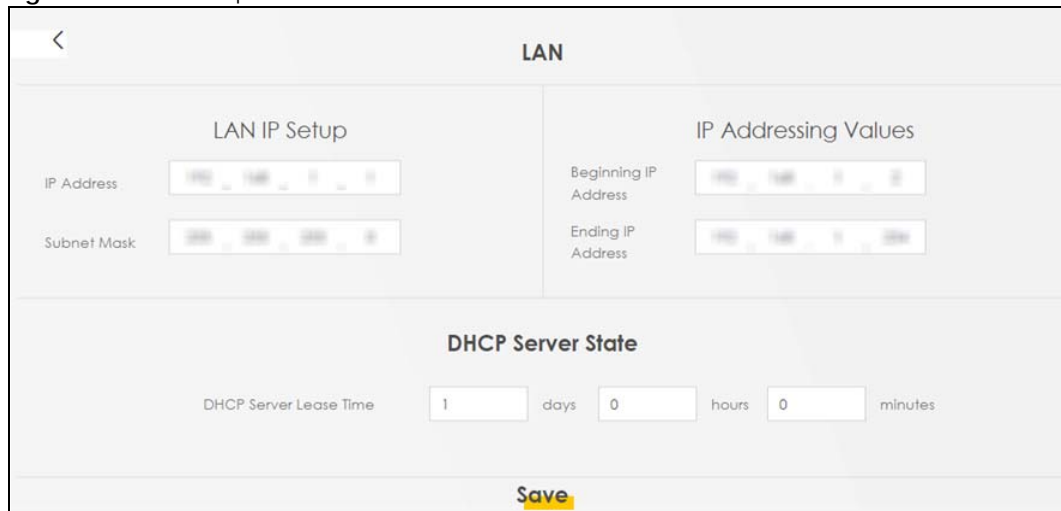

Each field is described in the following table.

Table 24 LAN Setup

LABEL	DESCRIPTION
LAN IP Setup	
IP Address	Enter the LAN IPv4 IP address you want to assign to your Zyxel Device in dotted decimal notation, for example, 192.168.123.1 (factory default).
Subnet Mask	Type the subnet mask of your network in dotted decimal notation, for example 255.255.255.0 (factory default). Your Zyxel Device automatically computes the subnet mask based on the IP Address you enter, so do not change this field unless you are instructed to do so.
IP Addressing Values	
Beginning IP Address	This field specifies the first of the contiguous addresses in the IP address pool.
Ending IP Address	This field specifies the last of the contiguous addresses in the IP address pool.
DHCP Server State	
DHCP Server Lease Time	This is the period of time a DHCP-assigned address is valid, before it expires. When a client connects to the Zyxel Device, DHCP automatically assigns the client an IP addresses from the IP address pool. DHCP leases each addresses for a limited period of time, which means that past addresses are "recycled" and made available for future reassignment to other devices.
Days/Hours/Minutes	Enter the lease time of the DHCP server.

7.3 The Parental Control Screen

Use this screen to view the number of profiles that were created for parental control.

Figure 53 Parental Control

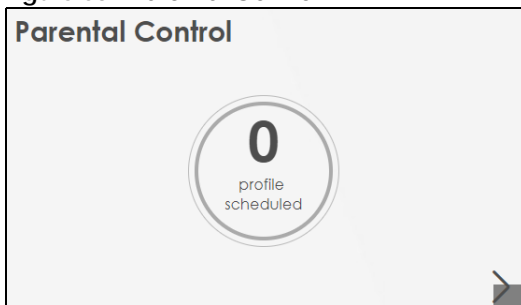

Click the yellow Arrow icon to open the following screen. Use this screen to enable parental control and add more profiles..

Figure 54 Parental Control

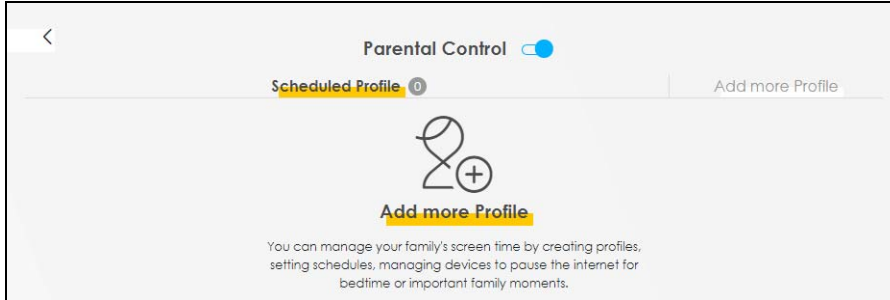

Each field is described in the following table.

Table 25 Parental Control: Schedule

LABEL	DESCRIPTION
Parental Control	Click this switch to enable or disable parental control. When the switch goes to the right (), the function is enabled. Otherwise, it is not.
Scheduled Profile	This screen shows all the created profiles.
Add More Profile	Click this to create a new profile.

7.3.1 Create a Parental Control Profile

Click **Add more Profile** to create a profile. Use this screen to add a devices in a profile and block Internet access on the profile devices.

Figure 55 Parental Control: Add More Profile

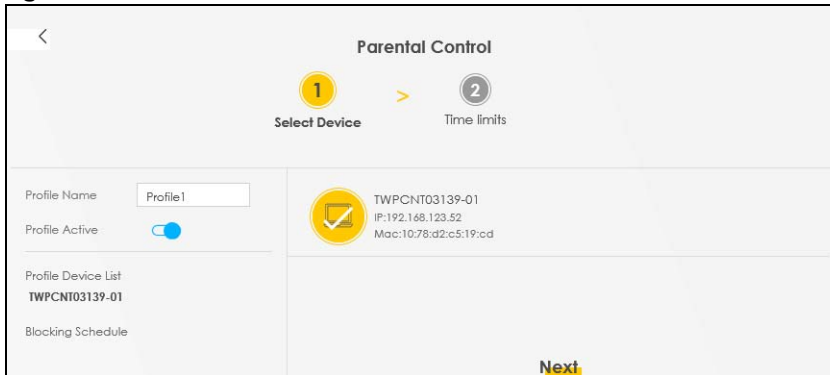

Each field is described in the following table.

Table 26 Parental Control: Add More Profile

LABEL	DESCRIPTION
Profile Name	Enter a descriptive name for the profile.
Profile Active	Click this switch to enable or disable Internet access. When the switch goes to the right  , the function is enabled. Otherwise, it is not.
Profile Device List	This field shows the devices selected on the right for this profile.
Blocking Schedule	This field shows the time during which Internet access is blocked on the profile device(s).
	Select a device(s) on your network for this profile.

7.3.2 Define a Schedule

Click **Next** to define time periods and days during which Internet access is blocked on the profile devices.

Figure 56 Parental Control: Schedule

The screenshot shows the 'Parental Control' interface. On the left, the profile name is 'Berto', it is active, and the device list includes 'TWPC2T02788-01'. The schedule is defined for 'Sun' from 7:00 am to 11:45 am. The 'Repeat On' section shows 'Sun' selected. The 'Active' switch is turned on. Buttons for 'Back' and 'Save' are visible at the bottom.

Each field is described in the following table.

Table 27 Parental Control: Schedule

LABEL	DESCRIPTION
Profile Name	Enter a descriptive name for the profile.
Profile Active	Click this switch to enable or disable Internet access. When the switch goes to the right  , the function is enabled. Otherwise, it is not.
Profile Device List	This field shows the devices selected on the right for this profile.
Blocking Schedule	This field shows the time during which Internet access is blocked on the profile devices.
Schedule	
Add New Schedule	Click this to add a new block for scheduling.
Start/End blocking	Select the time period when Internet access is blocked on the profile devices. Select All Day and the scheduler rule will be activated for 24 hours.
Repeat On	Select the days when Internet access is blocked on the profile devices.
Back	Click Back to return to the previous screen.
Save	Click Save to save your changes.

Once a profile is created, it will show in the following screen. Click this  to **Delete** or **Edit** a profile.

Figure 57 Parental Control: Edit_Delete

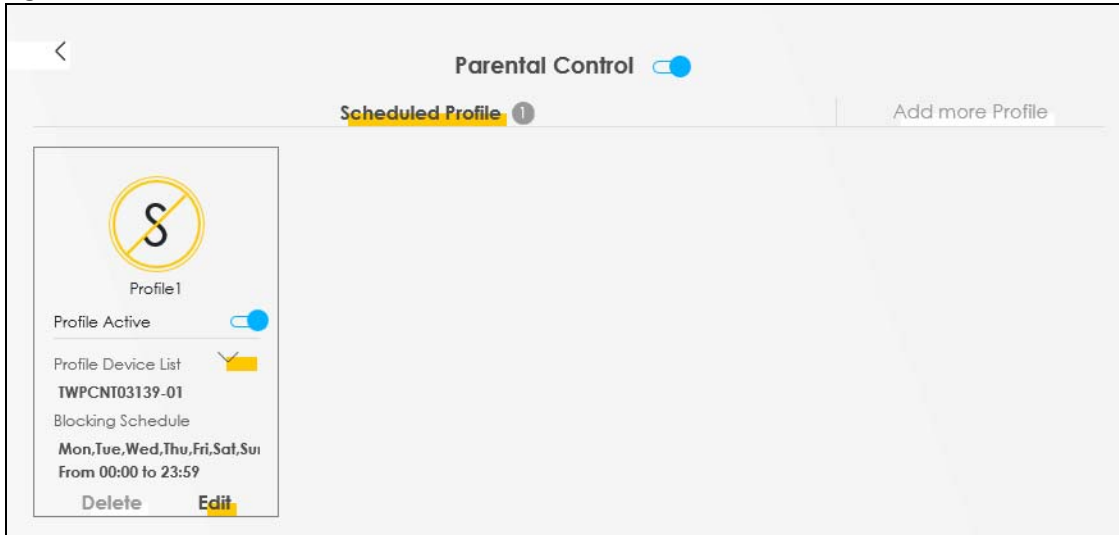

CHAPTER 8

Broadband

8.1 Broadband Overview

This chapter discusses the Zyxel Device's **Broadband** screens. Use these screens to configure your Zyxel Device for Internet access.

A WAN (Wide Area Network) connection is an outside connection to another network or the Internet. It connects your private networks, such as a LAN (Local Area Network) and other networks, so that a computer in one location can communicate with computers in other locations.

Figure 58 LAN and WAN

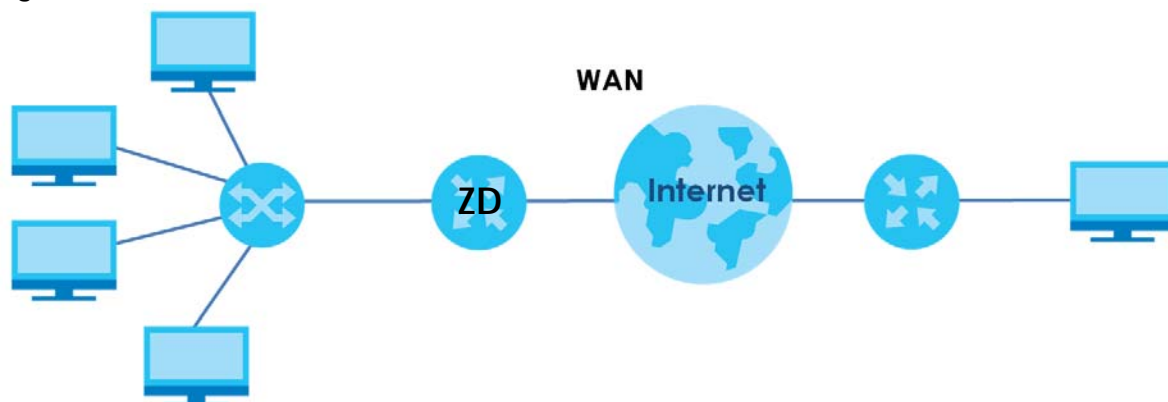

8.1.1 What You Can Do in this Chapter

- Use **Broadband** screens to view, remove or add a WAN interface. You can also configure the WAN settings on the Zyxel Device for Internet access ([Section 8.2 on page 109](#)).

Table 28 WAN Setup Overview

LAYER-2 INTERFACE	INTERNET CONNECTION		
	CONNECTION	MODE	ENCAPSULATION
Ethernet	Routing	PPPoE	PPP user name and password, WAN IPv4/IPv6 IP address, routing feature, DNS server, VLAN, and MTU
		IPoE	WAN IPv4/IPv6 IP address, NAT, DNS server and routing feature
	Bridge	N/A	VLAN

8.1.2 What You Need to Know

The following terms and concepts may help as you read this chapter.

WAN IP Address

The WAN IP address is an IP address for the Zyxel Device, which makes it accessible from an outside network. It is used by the Zyxel Device to communicate with other devices in other networks. It can be static (fixed) or dynamically assigned by the ISP each time the Zyxel Device tries to access the Internet.

If your ISP assigns you a static WAN IP address, they should also assign you the subnet mask and DNS server IP addresses.

IPv6 Introduction

IPv6 (Internet Protocol version 6), is designed to enhance IP address size and features. The increase in IPv6 address size to 128 bits (from the 32-bit IPv4 address) allows up to 3.4×10^{38} IP addresses. The Zyxel Device can use IPv4/IPv6 dual stack to connect to IPv4 and IPv6 networks, and supports IPv6 rapid deployment (6RD).

IPv6 Addressing

The 128-bit IPv6 address is written as eight 16-bit hexadecimal blocks separated by colons (:). This is an example IPv6 address `2001:0db8:1a2b:0015:0000:0000:1a2f:0000`.

IPv6 addresses can be abbreviated in two ways:

- Leading zeros in a block can be omitted. So `2001:0db8:1a2b:0015:0000:0000:1a2f:0000` can be written as `2001:db8:1a2b:15:0:0:1a2f:0`.
- Any number of consecutive blocks of zeros can be replaced by a double colon. A double colon can only appear once in an IPv6 address. So `2001:0db8:0000:0000:1a2f:0000:0000:0015` can be written as `2001:0db8::1a2f:0000:0000:0015`, `2001:0db8:0000:0000:1a2f::0015`, `2001:db8::1a2f:0:0:15` or `2001:db8:0:0:1a2f::15`.

IPv6 Prefix and Prefix Length

Similar to an IPv4 subnet mask, IPv6 uses an address prefix to represent the network address. An IPv6 prefix length specifies how many most significant bits (start from the left) in the address compose the network address. The prefix length is written as "/x" where x is a number. For example,

```
2001:db8:1a2b:15::1a2f:0/32
```

means that the first 32 bits (`2001:db8`) is the subnet prefix.

IPv6 Subnet Masking

Both an IPv6 address and IPv6 subnet mask compose of 128-bit binary digits, which are divided into eight 16-bit blocks and written in hexadecimal notation. Hexadecimal uses four bits for each character (1 – 10, A – F). Each block's 16 bits are then represented by four hexadecimal characters. For example, `FFFF:FFFF:FFFF:FFFF:FC00:0000:0000:0000`.

IPv6 Rapid Deployment

Use IPv6 Rapid Deployment (6rd) when the local network uses IPv6 and the ISP has an IPv4 network. When the Zyxel Device has an IPv4 WAN address and you set **IPv6/IPv4 Mode** to **IPv4 Only**, you can enable 6rd to encapsulate IPv6 packets in IPv4 packets to cross the ISP's IPv4 network.

The Zyxel Device generates a global IPv6 prefix from its IPv4 WAN address and tunnels IPv6 traffic to the ISP's Border Relay router (BR in the figure) to connect to the native IPv6 Internet. The local network can also use IPv4 services. The Zyxel Device uses its configured IPv4 WAN IP to route IPv4 traffic to the IPv4 Internet.

Figure 59 IPv6 Rapid Deployment

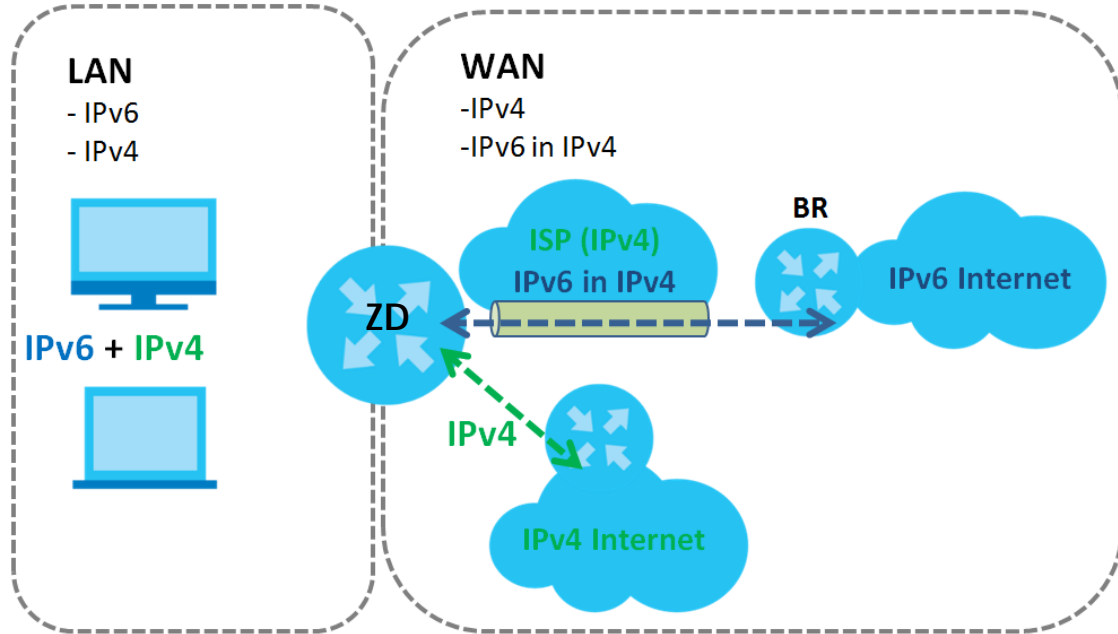

Dual Stack Lite

Use Dual Stack Lite when local network computers use IPv4 and the ISP has an IPv6 network. When the Zyxel Device has an IPv6 WAN address and you set **IPv6/IPv4 Mode** to **IPv6 Only**, you can enable Dual Stack Lite to use IPv4 computers and services.

The Zyxel Device tunnels IPv4 packets inside IPv6 encapsulation packets to the ISP's Address Family Transition Router (AFTR in the graphic) to connect to the IPv4 Internet. The local network can also use IPv6 services. The Zyxel Device uses its configured IPv6 WAN IP to route IPv6 traffic to the IPv6 Internet.

Figure 60 Dual Stack Lite

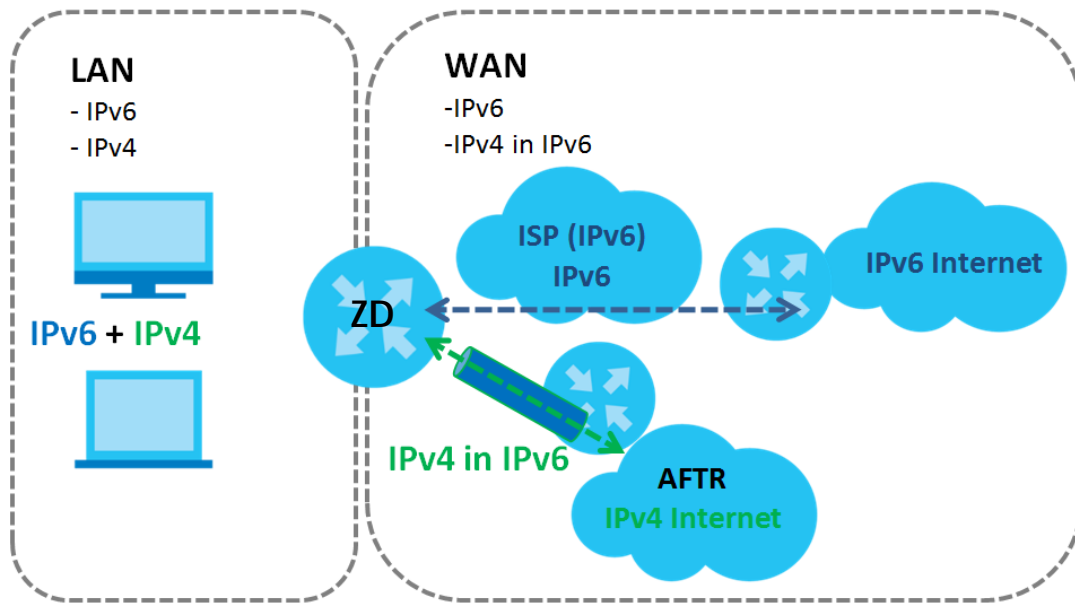

8.1.3 Before You Begin

You need to know your Internet access settings such as encapsulation and WAN IP address. Get this information from your ISP.

8.2 Broadband Settings

Use this screen to change your Zyxel Device's Internet access settings. The summary table shows you the configured WAN services (connections) on the Zyxel Device. Use information provided by your ISP to configure WAN settings.

Click **Network Setting > Broadband** to access this screen.

Figure 61 Network Setting > Broadband

Broadband												
Use this screen to change your Zyxel Device's Internet access settings. The summary table shows you the configured WAN services (connections) on the Zyxel Device. Use information provided by your ISP to configure WAN settings.												
#	Name	Type	Mode	Encapsulation	802.1p	802.1q	IGMP Proxy	NAT	Default Gateway	IPv6	MLD Proxy	Modify
1	ETHWAN	ETH	Routing	IPoE	N/A	N/A	Y	Y	Y	Y	Y	

The following table describes the labels in this screen.

Table 29 Network Setting > Broadband

LABEL	DESCRIPTION
#	This is the index number of the entry.
Name	This is the service name of the connection.
Type	This shows types of connections the Zyxel Device has.
Mode	This shows whether the connection is in routing or bridge mode.
Encapsulation	This is the method of encapsulation used by this connection.
802.1p	This indicates the 802.1p priority level assigned to traffic sent through this connection. This displays N/A when there is no priority level assigned.
802.1q	This indicates the VLAN ID number assigned to traffic sent through this connection. This displays N/A when there is no VLAN ID number assigned.
IGMP Proxy	This shows whether the Zyxel Device act as an IGMP proxy on this connection.
NAT	This shows whether NAT is activated or not for this connection.
Default Gateway	This shows whether the Zyxel Device use the WAN interface of this connection as the system default gateway.
IPv6	This shows whether IPv6 is activated or not for this connection. IPv6 is not available when the connection uses the bridging service.
MLD Proxy	This shows whether Multicast Listener Discovery (MLD) is activated or not for this connection. MLD is not available when the connection uses the bridging service.
Modify	Click the Edit icon to configure the WAN connection. Click the Delete icon to remove the WAN connection.

8.2.1 Edit Internet Connection

Click the Edit icon in the **Networking > Broadband** screen to open the following screen. Use this screen to configure a WAN connection. The screen varies depending on the mode, encapsulation, and IPv6 or IPv4 mode you select.

Routing Mode

Use **Routing** mode if your ISP give you one IP address only and you want multiple computers to share an Internet account.

The following example screen displays when you select the **Routing** mode and **IPoE** encapsulation. The screen varies when you select other encapsulation and IPv6 or IPv4 mode.

Figure 62 Network Setting > Broadband > Edit New WAN Interface (Ethernet)

The screenshot shows the 'Edit WAN Interface' configuration page. It is organized into a grid of sections:

- General:** Includes a toggle switch for 'General' (turned on), and fields for Name (ETHWAN), Type (Ethernet), Mode (Routing), Encapsulation (IPoE), and IPv4/IPv6 Mode (IPv4 IPv6 DualStack).
- VLAN:** Includes fields for 802.1p (0) and 802.1q (1-4094), and a section for MTU (1500).
- IP Address:** Radio buttons for 'Obtain an IP Address Automatically' (selected) and 'Static IP Address'.
- DNS Server:** Radio buttons for 'Obtain DNS Info Automatically' (selected) and 'Use Following Static DNS Address'.
- IPv6 Address:** Radio buttons for 'Obtain an IPv6 Address Automatically' (selected) and 'Static IPv6 Address'.
- IPv6 DNS Server:** Radio buttons for 'Obtain IPv6 DNS Info Automatically' (selected) and 'Use Following Static IPv6 DNS Address'.
- Routing Feature:** Toggle switches for 'NAT', 'IGMP Proxy', and 'Apply as Default Gateway', all of which are turned on.
- IPv6 Routing Feature:** Toggle switches for 'MLD Proxy' and 'Apply as Default Gateway', both of which are turned on.

At the bottom of the screen, there are 'Cancel' and 'Apply' buttons.

The following table describes the labels in this screen.

Table 30 Network Setting > Broadband > Edit New WAN Interface (Routing Mode)

LABEL	DESCRIPTION
General	Click this switch to enable or disable the interface. When the switch goes to the right  , the function is enabled. Otherwise, it is not.
Name	Specify a descriptive name for this connection. This field is read-only if you are editing the WAN interface.
Type	This field shows the types of available connections. This field is read-only if you are editing the WAN interface.
Mode	Select Routing if your ISP give you one IP address only and you want multiple computers to share an Internet account.
Encapsulation	Select the method of encapsulation used by your ISP from the drop-down list box. This option is available only when you select Routing in the Mode field. When you select Ethernet , the choices are PPPoE and IPoE .
IPv4/IPv6 Mode	Select IPv4 Only if you want the Zyxel Device to run IPv4 only. Select IPv4 IPv6 DualStack to allow the Zyxel Device to run IPv4 and IPv6 at the same time. Select IPv6 Only if you want the Zyxel Device to run IPv6 only.

Table 30 Network Setting > Broadband > Edit New WAN Interface (Routing Mode) (continued)





LABEL	DESCRIPTION
VLAN	Click this switch to enable or disable VLAN on this WAN interface. When the switch goes to the right  , the function is enabled. Otherwise, it is not.
802.1p	IEEE 802.1p defines up to 8 separate traffic types by inserting a tag into a MAC-layer frame that contains bits to define class of service. Select the IEEE 802.1p priority level (from 0 to 7) to add to traffic through this connection. The greater the number, the higher the priority level.
802.1q	Type the VLAN ID number (from 1 to 4094) for traffic through this connection.
MTU	Enter the MTU (Maximum Transfer Unit) size for traffic through this connection.
IP Address (This is available only when you select IPv4 Only or IPv4 IPv6 DualStack in the IPv4/IPv6 Mode field.)	
Obtain an IP Address Automatically	A static IP address is a fixed IP that your ISP gives you. A dynamic IP address is not fixed; the ISP assigns you a different one each time you connect to the Internet. Select this if you have a dynamic IP address.
Static IP Address	Select this option if the ISP assigned a fixed IP address.
IP Address	Enter the static IP address provided by your ISP.
Subnet Mask	Enter the subnet mask provided by your ISP. This is available only when you set the Encapsulation to IPoE .
Gateway IP Address	Enter the gateway IP address provided by your ISP. This is available only when you set the Encapsulation to IPoE .
DNS Server (This is available only when you select IPv4 Only or IPv4 IPv6 DualStack in the IPv4/IPv6 Mode field.)	
Obtain DNS Info Automatically	Select Obtain DNS Info Automatically if you want the Zyxel Device to use the DNS server addresses assigned by your ISP.
Use Following Static DNS Address	Select Use Following Static DNS Address if you want the Zyxel Device to use the DNS server addresses you configure manually.
Primary DNS Server	Enter the first DNS server address assigned by the ISP.
Secondary DNS Server	Enter the second DNS server address assigned by the ISP.
Routing Feature (This is available only when you select IPv4 Only or IPv4 IPv6 DualStack in the IPv4/IPv6 Mode field.)	
NAT	Click this switch to activate or deactivate NAT on this connection. When the switch goes to the right  , the function is enabled. Otherwise, it is not.
IGMP Proxy	Internet Group Multicast Protocol (IGMP) is a network-layer protocol used to establish membership in a Multicast group – it is not used to carry user data. Click this switch to have the Zyxel Device act as an IGMP proxy on this connection. When the switch goes to the right  , the function is enabled. Otherwise, it is not. This allows the Zyxel Device to get subscribing information and maintain a joined member list for each multicast group. It can reduce multicast traffic significantly.
Apply as Default Gateway	Click this switch to have the Zyxel Device use the WAN interface of this connection as the system default gateway. When the switch goes to the right  , the function is enabled. Otherwise, it is not.

Table 30 Network Setting > Broadband > Edit New WAN Interface (Routing Mode) (continued)



LABEL	DESCRIPTION
Fullcone NAT Enable	Click this switch to enable or disable full cone NAT on this connection. When the switch goes to the right  , the function is enabled. Otherwise, it is not. This field is available only when you activate NAT . In full cone NAT, the Zyxel Device maps all outgoing packets from an internal IP address and port to a single IP address and port on the external network. The Zyxel Device also maps packets coming to that external IP address and port to the internal IP address and port.
6RD	The 6RD (IPv6 rapid deployment) fields display when you set the IPv6/IPv4 Mode field to IPv4 Only . See IPv6 Rapid Deployment on page 108 for more information. Click this switch to tunnel IPv6 traffic from the local network through the ISP's IPv4 network. When the switch goes to the right  , the function is enabled. Otherwise, it is not.
Automatically configured by DHCP	The Automatically configured by DHCP option is configurable only when you set the method of encapsulation to IPoE .
Manually Configured	Select Manually Configured if you have the IPv4 address of the relay server. Otherwise, select Automatically configured by DHCP to have the Zyxel Device detect it automatically through DHCP.
Service Provider IPv6 Prefix	Enter an IPv6 prefix for tunneling IPv6 traffic to the ISP's border relay router and connecting to the native IPv6 Internet.
IPv4 Mask Length	Enter the subnet mask number (1 – 32) for the IPv4 network.
IPv6 Address (This is available only when you select IPv4 IPv6 DualStack or IPv6 Only in the IPv4/IPv6 Mode field.)	
Obtain an IPv6 Address Automatically	Select Obtain an IPv6 Address Automatically if you want to have the Zyxel Device use the IPv6 prefix from the connected router's Router Advertisement (RA) to generate an IPv6 address.
Static IPv6 Address	Select Static IPv6 Address if you have a fixed IPv6 address assigned by your ISP. When you select this, the following fields appear.
IPv6 Address	Enter an IPv6 IP address that your ISP gave to you for this WAN interface.
Prefix Length	Enter the address prefix length to specify how many most significant bits in an IPv6 address compose the network address.
IPv6 Default Gateway	Enter the IP address of the next-hop gateway. The gateway is a router or switch on the same segment as your Zyxel Device's interfaces. The gateway helps forward packets to their destinations.
IPv6 DNS Server (This is available only when you select IPv4 IPv6 DualStack or IPv6 Only in the IPv4/IPv6 Mode field. Configure the IPv6 DNS server in the following section.)	
Obtain IPv6 DNS Info Automatically	Select Obtain IPv6 DNS Info Automatically to have the Zyxel Device get the IPv6 DNS server addresses from the ISP automatically.
Use Following Static IPv6 DNS Address	Select Use Following Static IPv6 DNS Address to have the Zyxel Device use the IPv6 DNS server addresses you configure manually.
Primary DNS Server	Enter the first IPv6 DNS server address assigned by the ISP.
Secondary DNS Server	Enter the second IPv6 DNS server address assigned by the ISP.
IPv6 Routing Feature (This is available only when you select IPv4 IPv6 DualStack or IPv6 Only in the IPv4/IPv6 Mode field. You can enable IPv6 routing features in the following section.)	
MLD Proxy Enable	Select this check box to have the Zyxel Device act as an MLD proxy on this connection. This allows the Zyxel Device to get subscription information and maintain a joined member list for each multicast group. It can reduce multicast traffic significantly.

Table 30 Network Setting > Broadband > Edit New WAN Interface (Routing Mode) (continued)

LABEL	DESCRIPTION
Apply as Default Gateway	Select this option to have the Zyxel Device use the WAN interface of this connection as the system default gateway.
DS-Lite	This is available only when you select IPv6 Only in the IPv4/IPv6 Mode field. Enable Dual Stack Lite to let local computers use IPv4 through an ISP's IPv6 network. See Dual Stack Lite on page 108 for more information. Click this switch to let local computers use IPv4 through an ISP's IPv6 network. When the switch goes to the right  , the function is enabled. Otherwise, it is not.
DS-Lite Relay Server IP	Specify the transition router's IPv6 address.
Cancel	Click Cancel to restore your previously saved settings.
Apply	Click Apply to save your changes.

Bridge Mode

Click the **Edit** icon next to the connection you want to configure in the **Network Setting > Broadband** screen. The following example screen displays when you select **Bridge** mode.

Figure 63 Network Setting > Broadband > Edit New WAN Interface (Ethernet-Bridge Mode)

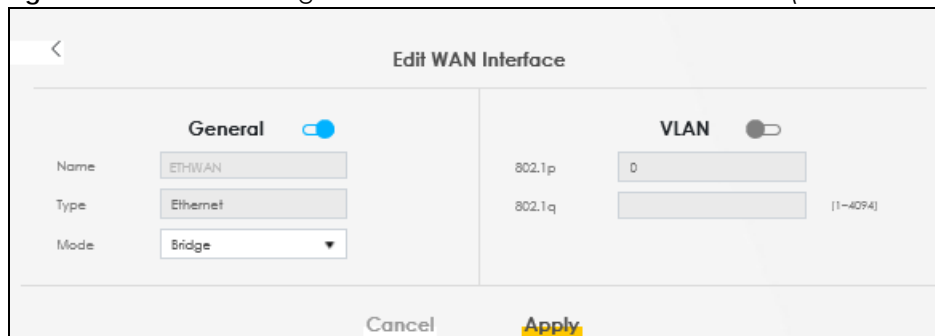

The following table describes the fields in this screen.

Table 31 Network Setting > Broadband > Edit New WAN Interface (VDSL over PTM or Ethernet-Bridge Mode)



LABEL	DESCRIPTION
General	Click this switch to enable or disable the interface. When the switch goes to the right  , the function is enabled. Otherwise, it is not.
Name	Enter a service name of the connection.
Type (Ethernet)	Select Ethernet as the interface that you want to configure. This field is read-only if you are editing the WAN interface.
Mode	Select Bridge when your ISP provides you more than one IP address and you want the connected computers to get individual IP address from ISP's DHCP server directly. If you select Bridge , you cannot use routing functions, such as Firewall, DHCP server and NAT on traffic from the selected LAN port(s).
VLAN	Click this switch to enable or disable VLAN on this WAN interface. When the switch goes to the right  , the function is enabled. Otherwise, it's not.

Table 31 Network Setting > Broadband > Edit New WAN Interface (VDSL over PTM or Ethernet-Bridge Mode) (continued)

LABEL	DESCRIPTION
802.1p	IEEE 802.1p defines up to 8 separate traffic types by inserting a tag into a MAC-layer frame that contains bits to define class of service. Select the IEEE 802.1p priority level (from 0 to 7) to add to traffic through this connection. The greater the number, the higher the priority level.
802.1q	Type the VLAN ID number (from 0 to 4094) for traffic through this connection.
Cancel	Click Cancel to exit this screen without saving.
Apply	Click Apply to save your changes.

8.3 Technical Reference

The following section contains additional technical information about the Zyxel Device features described in this chapter.

Encapsulation

Be sure to use the encapsulation method required by your ISP. The Zyxel Device can work in bridge mode or routing mode. When the Zyxel Device is in routing mode, it supports the following methods.

IP Address Assignment

A static IP is a fixed IP that your ISP gives you. A dynamic IP is not fixed; the ISP assigns you a different one each time. The Single User Account feature can be enabled or disabled if you have either a dynamic or static IP. However, the encapsulation method assigned influences your choices for IP address and default gateway.

Introduction to VLANs

A Virtual Local Area Network (VLAN) allows a physical network to be partitioned into multiple logical networks. Devices on a logical network belong to one group. A device can belong to more than one group. With VLAN, a device cannot directly talk to or hear from devices that are not in the same groups; the traffic must first go through a router.

In Multi-Tenant Unit (MTU) applications, VLAN is vital in providing isolation and security among the subscribers. When properly configured, VLAN prevents one subscriber from accessing the network resources of another on the same LAN, thus a user will not see the printers and hard disks of another user in the same building.

VLAN also increases network performance by limiting broadcasts to a smaller and more manageable logical broadcast domain. In traditional switched environments, all broadcast packets go to each and every individual port. With VLAN, all broadcasts are confined to a specific broadcast domain.

Introduction to IEEE 802.1Q Tagged VLAN

A tagged VLAN uses an explicit tag (VLAN ID) in the MAC header to identify the VLAN membership of a frame across bridges – they are not confined to the switch on which they were created. The VLANs can be created statically by hand or dynamically through GVRP. The VLAN ID associates a frame with a specific VLAN and provides the information that switches need to process the frame across the network. A tagged frame is 4 bytes longer than an untagged frame and contains 2 bytes of TPID (Tag Protocol Identifier), residing within the type/length field of the Ethernet frame) and 2 bytes of TCI (Tag Control Information), starts after the source address field of the Ethernet frame).

The CFI (Canonical Format Indicator) is a single-bit flag, always set to zero for Ethernet switches. If a frame received at an Ethernet port has a CFI set to 1, then that frame should not be forwarded as it is to an untagged port. The remaining twelve bits define the VLAN ID, giving a possible maximum number of 4,096 VLANs. Note that user priority and VLAN ID are independent of each other. A frame with VID (VLAN Identifier) of null (0) is called a priority frame, meaning that only the priority level is significant and the default VID of the ingress port is given as the VID of the frame. Of the 4096 possible VIDs, a VID of 0 is used to identify priority frames and value 4095 (FFF) is reserved, so the maximum possible VLAN configurations are 4,094.

TPID	User Priority	CFI	VLAN ID
2 Bytes	3 Bits	1 Bit	12 Bits

Multicast

IP packets are transmitted in either one of two ways – Unicast (1 sender – 1 recipient) or Broadcast (1 sender – everybody on the network). Multicast delivers IP packets to a group of hosts on the network – not everybody and not just 1.

Internet Group Multicast Protocol (IGMP) is a network-layer protocol used to establish membership in a Multicast group - it is not used to carry user data. IGMP version 2 (RFC 2236) is an improvement over version 1 (RFC 1112) but IGMP version 1 is still in wide use. If you would like to read more detailed information about interoperability between IGMP version 2 and version 1, please see sections 4 and 5 of RFC 2236. The class D IP address is used to identify host groups and can be in the range 224.0.0.0 to 239.255.255.255. The address 224.0.0.0 is not assigned to any group and is used by IP multicast computers. The address 224.0.0.1 is used for query messages and is assigned to the permanent group of all IP hosts (including gateways). All hosts must join the 224.0.0.1 group in order to participate in IGMP. The address 224.0.0.2 is assigned to the multicast routers group.

At start up, the Zyxel Device queries all directly connected networks to gather group membership. After that, the Zyxel Device periodically updates this information.

DNS Server Address Assignment

Use Domain Name System (DNS) to map a domain name to its corresponding IP address and vice versa, for instance, the IP address of www.zyxel.com is 204.217.0.2. The DNS server is extremely important because without it, you must know the IP address of a computer before you can access it.

The Zyxel Device can get the DNS server addresses in the following ways.

- 1 The ISP tells you the DNS server addresses, usually in the form of an information sheet, when you sign up. If your ISP gives you DNS server addresses, manually enter them in the DNS server fields.

- 2 If your ISP dynamically assigns the DNS server IP addresses (along with the Zyxel Device's WAN IP address), set the DNS server fields to get the DNS server address from the ISP.

IPv6 Addressing

The 128-bit IPv6 address is written as eight 16-bit hexadecimal blocks separated by colons (:). This is an example IPv6 address `2001:0db8:1a2b:0015:0000:0000:1a2f:0000`.

IPv6 addresses can be abbreviated in two ways:

- Leading zeros in a block can be omitted. So `2001:0db8:1a2b:0015:0000:0000:1a2f:0000` can be written as `2001:db8:1a2b:15:0:0:1a2f:0`.
- Any number of consecutive blocks of zeros can be replaced by a double colon. A double colon can only appear once in an IPv6 address. So `2001:0db8:0000:0000:1a2f:0000:0000:0015` can be written as `2001:0db8::1a2f:0000:0000:0015`, `2001:0db8:0000:0000:1a2f::0015`, `2001:db8::1a2f:0:0:15` or `2001:db8:0:0:1a2f::15`.

IPv6 Prefix and Prefix Length

Similar to an IPv4 subnet mask, IPv6 uses an address prefix to represent the network address. An IPv6 prefix length specifies how many most significant bits (start from the left) in the address compose the network address. The prefix length is written as "/x" where x is a number. For example,

`2001:db8:1a2b:15::1a2f:0/32`

means that the first 32 bits (`2001:db8`) is the subnet prefix.

CHAPTER 9

Wireless

9.1 Wireless Overview

This chapter describes the Zyxel Device's **Network Setting > Wireless** screens. Use these screens to set up your Zyxel Device's WiFi network and security settings.

9.1.1 What You Can Do in this Chapter

This section describes the Zyxel Device's **Wireless** screens. Use these screens to set up your Zyxel Device's WiFi connection.

- Use the **General** screen to enable the Wireless LAN, enter the SSID and select the WiFi security mode ([Section 9.2 on page 119](#)).
- Use the **Guest/More AP** screen to set up multiple WiFi networks on your Zyxel Device ([Section 9.3 on page 123](#)).
- Use the **MAC Authentication** screen to allow or deny WiFi clients based on their MAC addresses from connecting to the Zyxel Device ([Section 9.4 on page 127](#)).
- Use the **WPS** screen to enable or disable WPS, view or generate a security PIN (Personal Identification Number) ([Section 9.5 on page 128](#)).
- Use the **WMM** screen to enable WiFi MultiMedia (WMM) to ensure quality of service in WiFi networks for multimedia applications ([Section 9.6 on page 129](#)).
- Use the **Others** screen to configure WiFi advanced features, such as the RTS/CTS Threshold ([Section 9.7 on page 130](#)).
- Use the **Channel Status** screen to scan the number of accessing points and view the results ([Section 9.8 on page 133](#)).
- Use the **Mesh** screen to enable or disable Mesh on your Zyxel Device ([Section 9.9 on page 133](#)).
- Use the **Mesh Topology** screen to view the topology information ([Section 9.10 on page 134](#)).

9.1.2 What You Need to Know

Wireless Basics

"Wireless" is essentially radio communication. In the same way that walkie-talkie radios send and receive information over the airwaves, wireless networking devices exchange information with one another. A wireless networking device is just like a radio that lets your computer exchange information with radios attached to other computers. Like walkie-talkies, most wireless networking devices operate at radio frequency bands that are open to the public and do not require a license to use. However, wireless networking is different from that of most traditional radio communications in that there are a number of wireless networking standards available with different methods of data encryption.

WiFi6 / IEEE 802.11ax

WiFi6 is backwards compatible with IEEE 802.11a/b/g/n/ac and is most suitable in areas with a high concentration of users. WiFi6 devices support Target Wakeup Time (TWT) allowing them to automatically power down when they are inactive.

The following table displays the comparison of the different WiFi standards.

Table 32 WiFi Standards Comparison

WIFI STANDARD	MAXIMUM LINK RATE *	BAND	SIMULTANEOUS CONNECTIONS
802.11b	11 Mbps	2.4 GHz	1
802.11a/g	54 Mbps	2.4 GHz and 5 GHz	1
802.11n	600 Mbps	2.4 GHz and 5 GHz	1
802.11ac	6.93 Gbps	5 GHz	4
802.11ax	2.4 Gbps	2.4 GHz	128
	9.61 Gbps	5 GHz and 6 GHz	

* The maximum link rate is for reference under ideal conditions only.

Finding Out More

See [Section 9.11 on page 135](#) for advanced technical information on WiFi networks.

9.2 Wireless General Settings

Use this screen to enable the WiFi, enter the SSID and select the WiFi security mode. We recommend that you select **More Secure** to enable **WPA3-SAE** data encryption.

Note: If you are configuring the Zyxel Device from a computer connected by WiFi and you change the Zyxel Device's SSID, channel or security settings, you will lose your WiFi connection when you press **Apply**. You must change the WiFi settings of your computer to match the new settings on the Zyxel Device.

Click **Network Setting > Wireless** to open the **General** screen.

Figure 64 Network Setting > Wireless > General

General Guest/More AP MAC Authentication WPS WMM Others Channel Status Mesh Mesh Topology

Use this screen to enable the Wireless LAN, enter the SSID and select the wireless security mode. We recommend that you select **More Secure** to enable **WPA3-SAE/WPA2-PSK** data encryption.

Wireless

Wireless Smart Connect

Wireless Network Setup

Band: 2.4GHz

Wireless:

Channel: Auto Current: 5 / 40 MHz

Bandwidth: 20/40MHz

Control Sideband: Upper

Wireless Network Settings

Wireless Network Name: Zyxel_F801

Max Clients: 32

Hide SSID ⓘ

Multicast Forwarding

Note

(1) If you are configuring the Zyxel Device from a computer connected by WiFi and you change the Zyxel Device's SSID, channel or security settings, you will lose your WiFi connection when you press **Apply**. You must change the WiFi settings of your computer to match the new settings on the Zyxel Device.

BSSID: D4:1A:D1:3F:F8:01

Security Level

No Security More Secure (Recommended)

Progress bar: [Red bar] [Green bar]

Security Mode: WPA2-PSK

Generate password automatically

Enter 8-63 ASCII characters or 64 hexadecimal digits ("0-9", "A-F").

Password: [Masked password] ⓘ

Strength: [Progress bar] medium

Cancel **Apply**

The following table describes the general WiFi labels in this screen.

Table 33 Network Setting > Wireless > General

LABEL	DESCRIPTION
Wireless	
Smart Connect	Select Smart Connect and the 2.4 GHz and 5 GHz WiFi networks will use the same SSID and WiFi security settings.
Wireless/WiFi Network Setup	
Band	This shows the WiFi band which this radio profile is using. 2.4GHz is the frequency used by IEEE 802.11b/g/n/ax WiFi clients while 5GHz is used by IEEE 802.11a/n/ac/ax WiFi clients.
Wireless/WiFi	Click this switch to enable or disable WiFi in this field. When the switch turns blue  , the function is enabled. Otherwise, it is not.
Channel	Select a channel from the drop-down list box. The options vary depending on the frequency band and the country you are in. Use Auto to have the Zyxel Device automatically determine a channel to use.
Bandwidth	Select whether the Zyxel Device uses a WiFi channel width of 20MHz , 40MHz , 20/40MHz , 20/40/80MHz or 20/40/80/160MHz . A standard 20 MHz channel offers transfer speeds of up to 150 Mbps whereas a 40 MHz channel uses two standard channels and offers speeds of up to 300 Mbps. 40 MHz (channel bonding or dual channel) bonds two adjacent radio channels to increase throughput. The WiFi clients must also support 40 MHz. It is often better to use the 20 MHz setting in a location where the environment hinders the WiFi signal. An 80 MHz channel groups adjacent 40 MHz channels into pairs to increase bandwidth even higher. Select 20MHz if you want to lessen radio interference with other wireless devices in your neighborhood or the WiFi clients do not support channel bonding. Because not all devices support 40 MHz and/or 160 MHz channels, select 20/40MHz or 20/40/80/160MHz to allow the Zyxel Device to adjust the channel bandwidth automatically.
Control Sideband	This is available for some regions when you select a specific channel and set the Bandwidth field to 40MHz or 20/40MHz . Set whether the control channel (set in the Channel field) should be in the Lower or Upper range of channel bands.
Wireless/WiFi Network Settings	
Wireless/WiFi Network Name	The SSID (Service Set IDentity) identifies the service set with which a wireless device is associated. Wireless devices associating to the access point (AP) must have the same SSID. Enter a descriptive name (up to 32 English keyboard characters) for WiFi.
Max Clients	Specify the maximum number of clients that can connect to this network at the same time.
Hide SSID	Select this check box to hide the SSID in the outgoing beacon frame so a station cannot obtain the SSID through scanning using a site survey tool. This check box is grayed out if the WPS function is enabled in the Network Setting > Wireless > WPS screen.
Multicast Forwarding	Select this check box to allow the Zyxel Device to convert wireless multicast traffic into wireless unicast traffic.
BSSID	This shows the MAC address of the wireless interface on the Zyxel Device when WiFi is enabled.
Security Level	

Table 33 Network Setting > Wireless > General (continued)

LABEL	DESCRIPTION
Security Mode	Select More Secure (Recommended) to add security on this WiFi network. The WiFi clients which want to associate to this network must have same WiFi security settings as the Zyxel Device. When you select to use a security, additional options appears in this screen. Or you can select No Security to allow any client to associate this network without any data encryption or authentication. See the following sections for more details about this field.
Cancel	Click Cancel to restore your previously saved settings.
Apply	Click Apply to save your changes.

9.2.1 No Security

Select **No Security** to allow wireless stations to communicate with the access points without any data encryption or authentication.

Note: If you do not enable any WiFi security on your Zyxel Device, your network is accessible to any wireless networking device that is within range.

Figure 65 Wireless > General: No Security

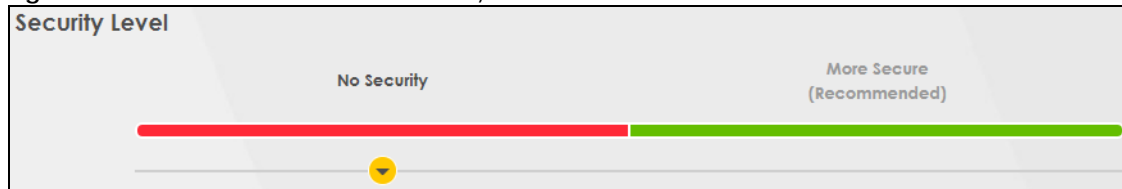

The following table describes the labels in this screen.

Table 34 Wireless > General: No Security

LABEL	DESCRIPTION
Security Level	Choose No Security to allow all WiFi connections without data encryption or authentication.

9.2.2 More Secure (Recommended)

The WPA-PSK (WiFi Protected Access-Pre-Shared Key) security mode provides both improved data encryption and user authentication over WEP. Using a pre-shared key, both the Zyxel Device and the connecting client share a common password in order to validate the connection. This type of encryption, while robust, is not as strong as WPA, WPA2 or even WPA2-PSK. The WPA2-PSK security mode is a more robust version of the WPA encryption standard. It offers better security, although the use of PSK makes it less robust than it could be.

The WPA3-SAE (Simultaneous Authentication of Equals handshake) security mode protects against dictionary attacks (password guessing attempts). It improves security by requiring a new encryption key every time a WPA3 connection is made. A handshake is the communication between the Zyxel Device and a connecting client at the beginning of a WiFi session.

Click **Network Setting > Wireless** to display the **General** screen. Select **More Secure** as the security level. Then select **WPA3-SAE** from the **Security Mode** list if your WiFi client supports it. If you are not sure, select **WPA3-SAE/WPA2-PSK** or **WPA2-PSK**.

Figure 66 Wireless > General: More Secure: WPA3-SAE/WPA2-PSK

The following table describes the labels in this screen.

Table 35 Wireless > General: More Secure: WPA3-SAE/WPA2-PSK

LABEL	DESCRIPTION
Security Level	Select More Secure to enable data encryption.
Security Mode	Select a security mode from the drop-down list box.
Generate password automatically	Select this option to have the Zyxel Device automatically generate a password. The password field will not be configurable when you select this option.
Password	Select Generate password automatically or enter a Password . The password has two uses. <ol style="list-style-type: none"> 1. Manual. Manually enter the same password on the Zyxel Device and the client. Enter 8 – 63 ASCII characters or exactly 64 hexadecimal ('0 – 9', 'a – f') characters. 2. WPS. When using WPS, the Zyxel Device sends this password to the client. Click the Eye icon to show or hide the password of your WiFi network. When the Eye icon is slashed  , you will see the password in plain text. Otherwise, it is hidden.

9.3 Guest/More AP Screen

Use this screen to configure a guest WiFi network that allows access to the Internet through the Zyxel Device. You can use one access point to provide several BSSs simultaneously. You can then assign varying security types to different SSIDs. WiFi clients can use different SSIDs to associate with the same access point.

Click **Network Setting > Wireless > Guest/More AP**.







The following table introduces the supported WiFi networks.

Table 36 Supported WiFi Networks

WIFI NETWORKS	WHERE TO CONFIGURE
Main/1	Network Setting > Wireless > General screen
Guest/3	Network Setting > Wireless > Guest/More AP screen

The following screen displays.

Figure 67 Network Setting > Wireless > Guest/More AP

This device can enable up to 4 wireless networks to work at the same time. Assign a name and a security level (if needed) to start the 2nd, 3rd, and 4th wireless network services.					
#	Status	SSID	Security	Guest WLAN	Modify
1		Zyxel_9DE5_guest1	WPA2-Personal	External Guest	
2		Zyxel_9DE5_guest2	WPA2-Personal	External Guest	
3		Zyxel_9DE5_guest3	WPA2-Personal	External Guest	

The following table describes the labels in this screen.

Table 37 Network Setting > Wireless > Guest/More AP

LABEL	DESCRIPTION
#	This is the index number of the entry.
Status	This field indicates whether this SSID is active. A yellow bulb signifies that this SSID is active, while a gray bulb signifies that this SSID is not active.
SSID	An SSID profile is the set of parameters relating to one of the Zyxel Device's BSSs. The SSID (Service Set Identifier) identifies the Service Set with which a wireless device is associated. This field displays the name of the WiFi profile on the network. When a WiFi client scans for an AP to associate with, this is the name that is broadcast and seen in the WiFi client utility.
Security	This field indicates the security mode of the SSID profile.
Guest WLAN	This displays if the guest WLAN function has been enabled for this WLAN. If Home Guest displays, clients can connect to each other directly. If External Guest displays, clients are blocked from connecting to each other directly. N/A displays if guest WLAN is disabled.
Modify	Click the Edit icon of an SSID profile to configure the SSID profile.

9.3.1 The Edit Guest/More AP Screen

Use this screen to create Guest and additional WiFi networks with different security settings.

Note: If upstream/downstream bandwidth is empty, the Zyxel Device sets the value automatically. Setting a maximum upstream/downstream bandwidth will significantly decrease WiFi performance.

Click the **Edit** icon next to an SSID in the **Guest/More AP** screen. The following screen displays.

Figure 68 Network Setting > Wireless > Guest/More AP > Edit

The following table describes the fields in this screen.

Table 38 Network Setting > Wireless > Guest/More AP > Edit



LABEL	DESCRIPTION
WiFi/Wireless Network Setup	
WiFi/Wireless	Click this switch to enable or disable the WiFi in this field. When the switch turns blue  , the function is enabled; otherwise, it is not.
WiFi/Wireless Network Settings	
WiFi/Wireless Network Name	The SSID (Service Set Identity) identifies the service set with which a wireless device is associated. Wireless devices associating to the access point (AP) must have the same SSID. Enter a descriptive name (up to 32 English keyboard characters) for the WiFi.
Hide SSID	Select this check box to hide the SSID in the outgoing beacon frame so a station cannot obtain the SSID through scanning using a site survey tool.

Table 38 Network Setting > Wireless > Guest/More AP > Edit (continued)

LABEL	DESCRIPTION
Guest WLAN	Select this to create Guest WLANs for home and external clients. Select the WLAN type in the Access Scenario field.
Access Scenario	If you select Home Guest , clients can connect to each other directly. If you select External Guest , clients are blocked from connecting to each other directly.
BSSID	This shows the MAC address of the WiFi interface on the Zyxel Device when WiFi is enabled.
SSID Subnet	Click on this switch to Enable this function if you want the WiFi network interface to assign DHCP IP addresses to the associated WiFi clients. This option cannot be used if the WPS function is enabled in the Network Setting > Wireless > WPS screen or if the Smart Connect check box is selected in Network Setting > Wireless > General .
DHCP Start Address	Specify the first of the contiguous addresses in the DHCP IP address pool. The Zyxel Device assigns IP addresses from this DHCP pool to WiFi clients connecting to the SSID.
DHCP End Address	Specify the last of the contiguous addresses in the DHCP IP address pool.
SSID Subnet Mask	Specify the subnet mask of the Zyxel Device for the SSID subnet.
LAN IP Address	Specify the IP address of the Zyxel Device for the SSID subnet.
Security Level	
Security Mode	Select More Secure (Recommended) to add security on this WiFi network. The WiFi clients which want to associate to this network must have the same WiFi security settings as the Zyxel Device. After you select to use a security, additional options appears in this screen. Or you can select No Security to allow any client to associate this network without any data encryption or authentication. See Section 9.2.1 on page 122 for more details about this field.
Generate password automatically	Select this option to have the Zyxel Device automatically generate a password. The password field will not be configurable when you select this option.
Password	WPA2-PSK uses a simple common password, instead of user-specific credentials. If you did not select Generate password automatically , you can manually type a pre-shared key from 8 to 64 case-sensitive keyboard characters. Click the Eye icon to show or hide the password of your WiFi network. When the Eye icon is slashed  , you'll see the password in plain text. Otherwise, it's hidden.
Strength	This displays the current password strength – weak, medium, strong . Click this  to show more fields in this section. Click again to hide them.
Encryption	Select the encryption type (AES or TKIP+AES) for data encryption. Select AES if your WiFi clients can all use AES. Select TKIP+AES to allow the WiFi clients to use either TKIP or AES. Not all models support the TKIP+AES option.
Timer	The Timer is the rate at which the RADIUS server sends a new group key out to all clients.
Cancel	Click Cancel to exit this screen without saving.
OK	Click OK to save your changes.

9.4 MAC Authentication

Use this screen to give exclusive access to specific devices (**Allow**) or exclude specific devices from accessing the Zyxel Device (**Deny**), based on the MAC address of each device. Every Ethernet device has a unique factory-assigned MAC (Media Access Control) address, which consists of six pairs of hexadecimal characters, for example: 00:A0:C5:00:00:02. You need to know the MAC addresses of the device you want to allow/deny to configure this screen.

Note: You can have up to 25 MAC authentication rules.

Use this screen to view your Zyxel Device's MAC filter settings and add new MAC filter rules. Click **Network Setting > Wireless > MAC Authentication**. The screen appears as shown.

Figure 69 Network Setting > Wireless > MAC Authentication

The screenshot shows the MAC Authentication configuration interface. Under the 'General' section, the SSID is 'Zyxel_IDF1'. The 'MAC Restrict Mode' is set to 'Allow' (radio button selected). Below this is the 'MAC address List' section, which contains a table with three columns: '#', 'MAC Address', and 'Modify'. To the right of the table is a '+ Add new MAC address' button. At the bottom of the screen are 'Cancel' and 'Apply' buttons.

The following table describes the labels in this screen.

Table 39 Network Setting > Wireless > MAC Authentication

LABEL	DESCRIPTION
General	
SSID	Select the SSID for which you want to configure MAC filter settings.
MAC Restrict Mode	Define the filter action for the list of MAC addresses in the MAC Address table. Select Disable to turn off MAC filtering. Select Deny to block access to the Zyxel Device. MAC addresses not listed will be allowed to access the Zyxel Device. Select Allow to permit access to the Zyxel Device. MAC addresses not listed will be denied access to the Zyxel Device.
MAC address List	

Table 39 Network Setting > Wireless > MAC Authentication (continued)

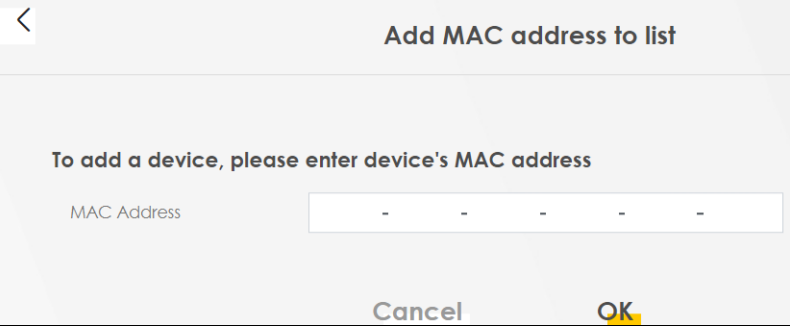
LABEL	DESCRIPTION
Add new MAC address	<p>This field is available when you select Deny or Allow in the MAC Restrict Mode field.</p> <p>Click this if you want to add a new MAC address entry to the MAC filter list below.</p> <p>Enter the MAC addresses of the WiFi devices that are allowed or denied access to the Zyxel Device in these address fields. Enter the MAC addresses in a valid MAC address format, that is, six hexadecimal character pairs, for example, 12:34:56:78:9a:bc.</p> 
#	This is the index number of the entry.
MAC Address	This is the MAC addresses of the WiFi devices that are allowed or denied access to the Zyxel Device.
Modify	<p>Click the Edit icon and type the MAC address of the peer device in a valid MAC address format (six hexadecimal character pairs, for example 12:34:56:78:9a:bc).</p> <p>Click the Delete icon to delete the entry.</p>
Cancel	Click Cancel to exit this screen without saving.
Apply	Click Apply to save your changes.

9.5 WPS

Use this screen to configure WiFi Protected Setup (WPS) on your Zyxel Device.

WiFi Protected Setup (WPS) allows you to quickly set up a WiFi network with strong security, without having to configure security settings manually. Select one of the WPS methods and follow the instructions to establish a WPS connection. Your devices must support WPS to use this feature. We recommend using Push Button Configuration (**PBC**) if your device supports it. See [Section 9.11.8.1 on page 140](#) for more information about WPS.

Note: The Zyxel Device applies the security settings of the main SSID (**SSID1**) profile to the WPS WiFi connection (see [Section 9.2.2 on page 122](#)).

Note: The WPS switch is unavailable if the WiFi is disabled.
If WPS is enabled, UPnP will automatically be turned on.

Click **Network Setting > Wireless > WPS**. The following screen displays. Click this switch and it will turn blue. Click **Apply** to activate the WPS function. Then you can configure the WPS settings in this screen.

Figure 70 Network Setting > Wireless > WPS

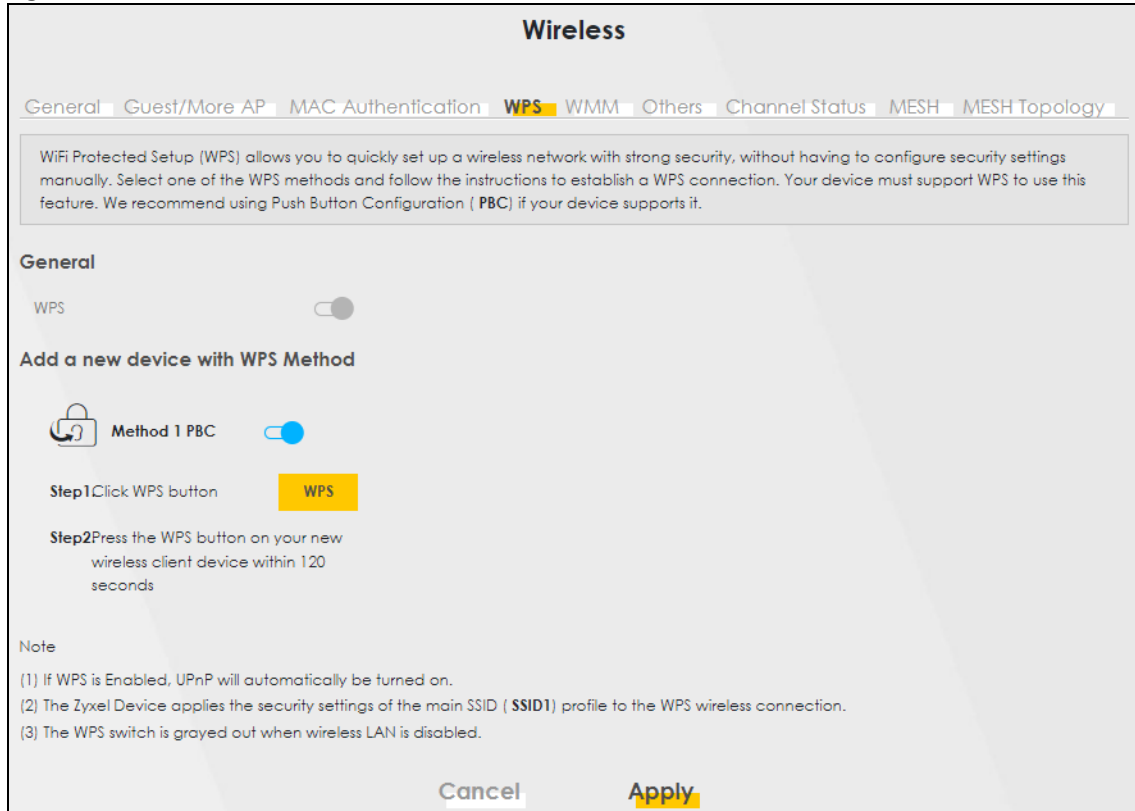

The following table describes the labels in this screen.

Table 40 Network Setting > Wireless > WPS

LABEL	DESCRIPTION
General	
WPS	Click to enable () and have the Zyxel Device activate WPS. Otherwise, it is disabled.
Add a new device with WPS Method	
Method 1 PBC	Use this section to set up a WPS WiFi network using Push Button Configuration (PBC). Click this switch to make it turn blue. Click Apply to activate WPS method 1 on the Zyxel Device.
WPS	Click this button to add another WPS-enabled WiFi device (within WiFi range of the Zyxel Device) to your WiFi network. This button may either be a physical button on the outside of a device, or a menu button similar to the WPS button on this screen. Note: You must press the other WiFi device's WPS button within 2 minutes of pressing this button.
Cancel	Click Cancel to restore your previously saved settings.
Apply	Click Apply to save your changes.

9.6 WMM

Use this screen to enable WiFi MultiMedia (WMM) and WMM Automatic Power Save (APSD) in WiFi networks for multimedia applications. WMM enhances data transmission quality, while APSD improves

power management of WiFi clients. This allows delay-sensitive applications, such as voice and videos, to run more smoothly.

Click **Network Setting > Wireless > WMM** to display the following screen.

Figure 71 Network Setting > Wireless > WMM

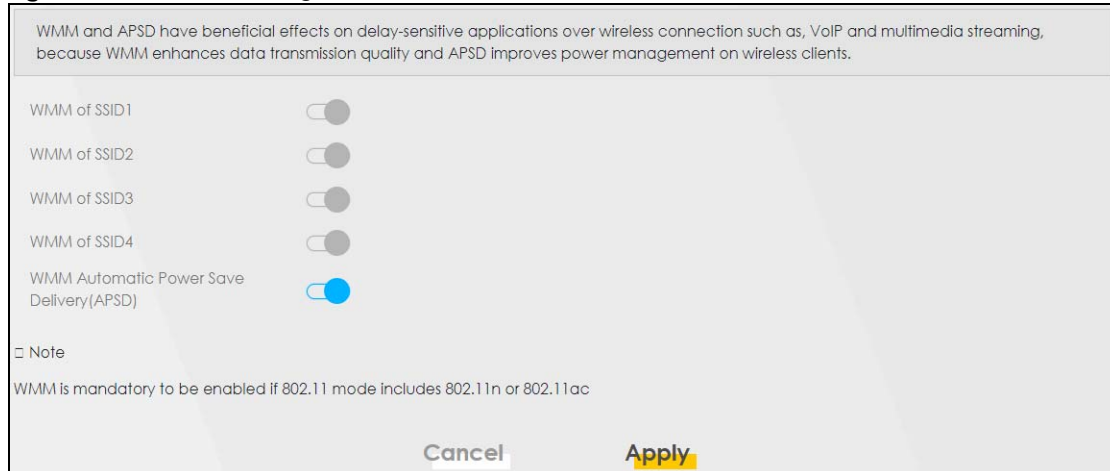

Note: **WMM** cannot be disabled if 802.11 mode includes 802.11n or 802.11ac.

Note: APSD only affects SSID1. For SSID2-SSID4, APSD is always enabled.

The following table describes the labels in this screen.

Table 41 Network Setting > Wireless > WMM

LABEL	DESCRIPTION
WMM of SSID	Select On to have the Zyxel Device automatically give the WiFi network (SSIDx) a priority level according to the ToS value in the IP header of packets it sends. WMM QoS (WiFi MultiMedia Quality of Service) gives high priority to video, which makes them run more smoothly. If the 802.11 Mode in Network Setting > Wireless > Others is set to include 802.11n or 802.11ac, WMM cannot be disabled.
WMM Automatic Power Save Delivery (APSD)	Select this option to extend the battery life of your mobile devices (especially useful for small devices that are running multimedia applications). The Zyxel Device goes to sleep mode to save power when it is not transmitting data. The AP buffers the packets sent to the Zyxel Device until the Zyxel Device "wakes up." The Zyxel Device wakes up periodically to check for incoming data. Note: This works only if the WiFi device to which the Zyxel Device is connected also supports this feature.
Cancel	Click Cancel to restore your previously saved settings.
Apply	Click Apply to save your changes.

9.7 Others Screen

Use this screen to configure advanced WiFi settings, such as additional security settings, power saving, and data transmission settings. Click **Network Setting > Wireless > Others**. The screen appears as shown.

See [Section 9.11.2 on page 136](#) for detailed definitions of the terms listed here.

Figure 72 Network Setting > Wireless > Others

RTS/CTS Threshold	<input type="text" value="2347"/>	
Fragmentation Threshold	<input type="text" value="2346"/>	
Output Power	<input type="text" value="100%"/>	▼
Beacon Interval	<input type="text" value="100"/>	ms
DTIM Interval	<input type="text" value="1"/>	ms
802.11 Mode	<input type="text" value="802.11b/g/n/ax Mixed"/>	▼
802.11 Protection	<input type="text" value="Auto"/>	▼
Preamble	<input type="text" value="Long"/>	
Protected Management Frames	<input type="text" value="Capable"/>	▼
<input type="button" value="Cancel"/> <input type="button" value="Apply"/>		

The following table describes the labels in this screen.

Table 42 Network Setting > Wireless > Others

LABEL	DESCRIPTION
RTS/CTS Threshold	Data with its frame size larger than this value will perform the RTS (Request To Send)/CTS (Clear To Send) handshake. Enter a value between 0 and 2347.
Fragmentation Threshold	This is the maximum data fragment size that can be sent. Enter a value between 256 and 2346.
Output Power	Set the output power of the Zyxel Device. If there is a high density of APs in an area, decrease the output power to reduce interference with other APs. Select one of the following: 20%, 40%, 60%, 80% or 100% .
Beacon Interval	When a wirelessly networked device sends a beacon, it includes with it a beacon interval. This specifies the time period before the device sends the beacon again. The interval tells receiving devices on the network how long they can wait in low power mode before waking up to handle the beacon. This value can be set from 50 ms to 1000 ms. A high value helps save current consumption of the access point.
DTIM Interval	Delivery Traffic Indication Message (DTIM) is the time period after which broadcast and multicast packets are transmitted to mobile clients in the Power Saving mode. A high DTIM value can cause clients to lose connectivity with the network. This value can be set from 1 to 255.

Table 42 Network Setting > Wireless > Others (continued)

LABEL	DESCRIPTION
802.11 Mode	<p>For 2.4 GHz frequency WiFi devices:</p> <ul style="list-style-type: none"> • Select 802.11b Only to allow only IEEE 802.11b compliant WiFi devices to associate with the Zyxel Device. • Select 802.11g Only to allow only IEEE 802.11g compliant WiFi devices to associate with the Zyxel Device. • Select 802.11n Only to allow only IEEE 802.11n compliant WiFi devices to associate with the Zyxel Device. • Select 802.11b/g Mixed to allow either IEEE 802.11b or IEEE 802.11g compliant WiFi devices to associate with the Zyxel Device. The transmission rate of your Zyxel Device might be reduced. • Select 802.11b/g/n Mixed to allow IEEE 802.11b, IEEE 802.11g or IEEE 802.11n compliant WiFi devices to associate with the Zyxel Device. The transmission rate of your Zyxel Device might be reduced. • Select 802.11b/g/n/ax Mixed to allow IEEE 802.11b, IEEE 802.11g, IEEE 802.11n or IEEE 802.11ax compliant WiFi devices to associate with the Zyxel Device. The transmission rate of your Zyxel Device might be reduced. <p>For 5 GHz frequency WiFi devices:</p> <ul style="list-style-type: none"> • Select 802.11a Only to allow only IEEE 802.11a compliant WiFi devices to associate with the Zyxel Device. • Select 802.11n Only to allow only IEEE 802.11n compliant WiFi devices to associate with the Zyxel Device. • Select 802.11ac Only to allow only IEEE 802.11ac compliant WiFi devices to associate with the Zyxel Device. • Select 802.11a/n Mixed to allow either IEEE 802.11a or IEEE 802.11n compliant WiFi devices to associate with the Zyxel Device. The transmission rate of your Zyxel Device might be reduced. • Select 802.11n/ac Mixed to allow either IEEE 802.11n or IEEE 802.11ac compliant WiFi devices to associate with the Zyxel Device. The transmission rate of your Zyxel Device might be reduced. • Select 802.11a/n/ac Mixed to allow IEEE 802.11a, IEEE 802.11n or IEEE 802.11ac compliant WiFi devices to associate with the Zyxel Device. The transmission rate of your Zyxel Device might be reduced. • Select 802.11a/n/ac/ax Mixed to allow IEEE 802.11a, IEEE 802.11n, IEEE 802.11ac or IEEE 802.11ax compliant WiFi devices to associate with the Zyxel Device. The transmission rate of your Zyxel Device might be reduced.
802.11 Protection	<p>Enabling this feature can help prevent collisions in mixed-mode networks (networks with both IEEE 802.11b and IEEE 802.11g traffic).</p> <p>Select Auto to have the wireless devices transmit data after a RTS/CTS handshake. This helps improve IEEE 802.11g performance.</p> <p>Select Off to disable 802.11 protection. The transmission rate of your Zyxel Device might be reduced in a mixed-mode network.</p> <p>This field displays Off and is not configurable when you set 802.11 Mode to 802.11b Only.</p>
Preamble	<p>Select a preamble type from the drop-down list box. Choices are Long or Short. See Section 9.11.7 on page 139 for more information.</p> <p>This field is configurable only when you set 802.11 Mode to 802.11b.</p>
Protected Management Frames	<p>WiFi with Protected Management Frames (PMF) provides protection for unicast and multicast management action frames. Unicast management action frames are protected from both eavesdropping and forging, and multicast management action frames are protected from forging. Select Capable if the WiFi client supports PMF, then the management frames will be encrypted. Select Required to force the WiFi client to support PMF; otherwise the authentication cannot be performed by the Zyxel Device. Otherwise, select Disabled.</p>
Cancel	<p>Click Cancel to restore your previously saved settings.</p>
Apply	<p>Click Apply to save your changes.</p>

9.8 Channel Status

Use this screen to scan for WiFi channel noise and view the results. Click **Scan** to start, and then view the results in the **Channel Scan Result** section. The value on each channel number indicates the number of Access Points (AP) using that channel. The Auto-channel-selection algorithm does not always directly follow the AP count; other factors about the channels are also considered. Click **Network Setting > Wireless > Channel Status**. The screen appears as shown.

Note: If the current channel is a DFS channel, the warning 'Channel scan process is denied because current channel is a DFS channel (Channel: 52 – 140). If you want to run channel scan, please select a non-DFS channel and try again.' appears.

Note: The AP count may not be a real-time value.

Figure 73 Network Setting > Wireless > Channel Status



9.9 Mesh

Use this screen to enable or disable **Mesh** on the Zyxel Device. Click **Network Setting > Wireless > Mesh** to open the following screen.

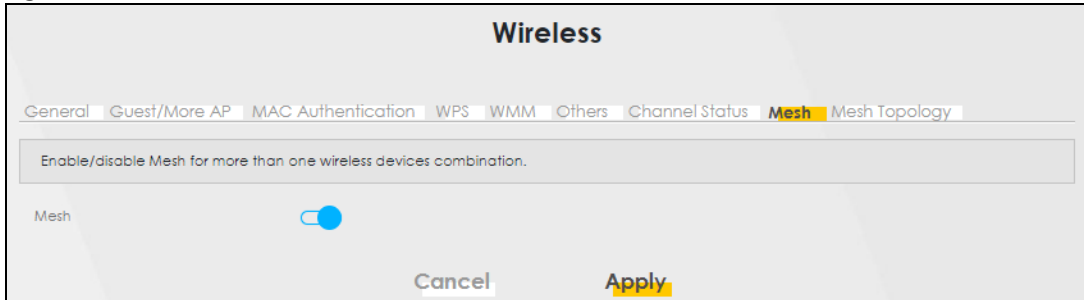
Figure 74 Network Setting > Wireless > Mesh

The following table describes the labels in this screen.

Table 43 Network Setting > Wireless > Mesh

LABEL	DESCRIPTION
Mesh	Slide the switch to the right () to enable Mesh .
OK	Click OK to save the changes back to the Zyxel Device.
Cancel	Click Cancel to close the window with changes unsaved.

9.10 Mesh Topology

Use this screen to configure the MAC address of the extender connected to the Zyxel Device. Click **Network Setting > Wireless > Mesh Topology** to open the following screen.

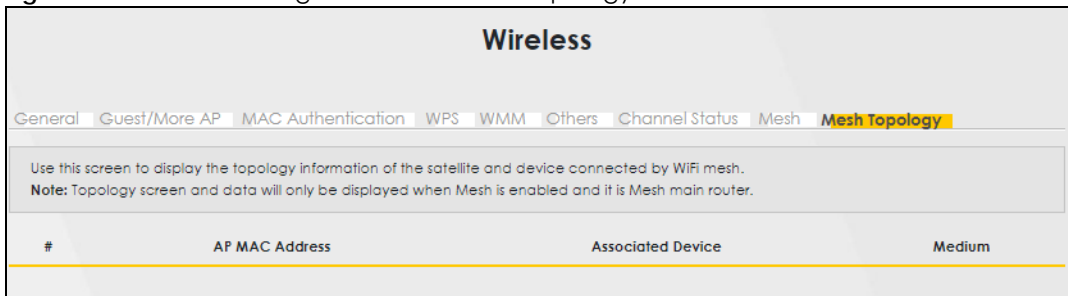
Figure 75 Network Setting > Wireless > Mesh Topology

The following table describes the labels in this screen.

Table 44 Network Setting > Wireless > Mesh Topology

LABEL	DESCRIPTION
#	This is the index number of the entry.
AP MAC Address	This show the MAC address of the satellites connected to the router. The router functions as a network controller to coordinate and optimize WiFi activity In a Mesh network. The controller collects Channel Availability Check responses and scan reports from the satellites. Then, the controller selects the best channel and the final optimized topology based on the current situation.
Associated Device	This shows the MAC address of the client devices connected to the Mesh network.
Medium	This shows the WiFi channel through which the WiFi networks can send and receive data.

9.11 Technical Reference

This section discusses WiFi in depth.

9.11.1 WiFi Network Overview

WiFi networks consist of WiFi clients, access points and bridges.

- A WiFi client is a radio connected to a user's computer.
- An access point is a radio with a wired connection to a network, which can connect with numerous WiFi clients and let them access the network.
- A bridge is a radio that relays communications between access points and WiFi clients, extending a network's range.

Normally, a WiFi network operates in an "infrastructure" type of network. An "infrastructure" type of network has one or more access points and one or more WiFi clients. The WiFi clients connect to the access points.

The following figure provides an example of a WiFi network.

Figure 76 Example of a WiFi Network

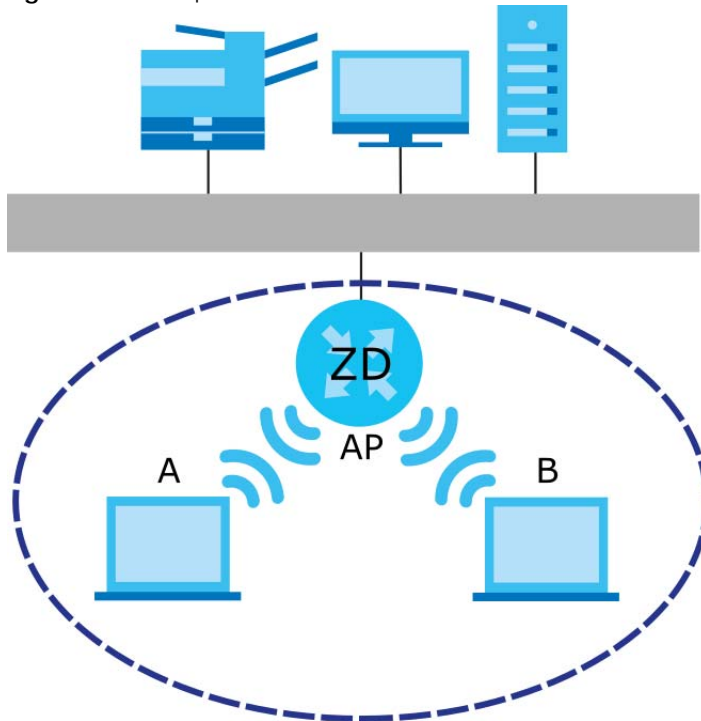

The WiFi network is the part in the blue circle. In this WiFi network, devices **A** and **B** use the access point (**AP**) to interact with the other devices (such as the printer) or with the Internet. Your Zyxel Device is the AP.

Every WiFi network must follow these basic guidelines.

- Every device in the same WiFi network must use the same SSID.
The SSID is the name of the WiFi network. It stands for Service Set Identifier.

- If two WiFi networks overlap, they should use a different channel.

Like radio stations or television channels, each WiFi network uses a specific channel, or frequency, to send and receive information.

- Every device in the same WiFi network must use security compatible with the AP.

Security stops unauthorized devices from using the WiFi network. It can also protect the information that is sent in the WiFi network.

9.11.2 Additional WiFi Terms

The following table describes some WiFi network terms and acronyms used in the Zyxel Device's Web Configurator.

Table 45 Additional WiFi Terms

TERM	DESCRIPTION
RTS/CTS Threshold	<p>In a WiFi network which covers a large area, WiFi devices are sometimes not aware of each other's presence. This may cause them to send information to the AP at the same time and result in information colliding and not getting through.</p> <p>By setting this value lower than the default value, the WiFi devices must sometimes get permission to send information to the Zyxel Device. The lower the value, the more often the devices must get permission.</p> <p>If this value is greater than the fragmentation threshold value (see below), then WiFi devices never have to get permission to send information to the Zyxel Device.</p>
Preamble	A preamble affects the timing in your WiFi network. There are two preamble modes: long and short. If a device uses a different preamble mode than the Zyxel Device does, it cannot communicate with the Zyxel Device.
Authentication	The process of verifying whether a WiFi device is allowed to use the WiFi network.
Fragmentation Threshold	A small fragmentation threshold is recommended for busy networks, while a larger threshold provides faster performance if the network is not very busy.

9.11.3 WiFi Security Overview

By their nature, radio communications are simple to intercept. For WiFi data networks, this means that anyone within range of a WiFi network without security can not only read the data passing over the airwaves, but also join the network. Once an unauthorized person has access to the network, he or she can steal information or introduce malware (malicious software) intended to compromise the network. For these reasons, a variety of security systems have been developed to ensure that only authorized people can use a WiFi data network, or understand the data carried on it.

These security standards do two things. First, they authenticate. This means that only people presenting the right credentials (often a username and password, or a "key" phrase) can access the network. Second, they encrypt. This means that the information sent over the air is encoded. Only people with the code key can understand the information, and only people who have been authenticated are given the code key.

These security standards vary in effectiveness. Some can be broken, such as the old Wired Equivalent Protocol (WEP). Using WEP is better than using no security at all, but it will not keep a determined attacker out. Other security standards are secure in themselves but can be broken if a user does not use them properly. For example, the WPA-PSK security standard is very secure if you use a long key which is difficult for an attacker's software to guess – for example, a twenty-letter long string of apparently random numbers and letters – but it is not very secure if you use a short key which is very easy to guess – for example, a three-letter word from the dictionary.

Because of the damage that can be done by a malicious attacker, it is not just people who have sensitive information on their network who should use security. Everybody who uses any WiFi network should ensure that effective security is in place.

A good way to come up with effective security keys, passwords and so on is to use obscure information that you personally will easily remember, and to enter it in a way that appears random and does not include real words. For example, if your mother owns a 1970 Dodge Challenger and her favorite movie is Vanishing Point (which you know was made in 1971) you could use "70dodchal71vanpoi" as your security key.

The following sections introduce different types of WiFi security you can set up in the WiFi network.

9.11.3.1 SSID

Normally, the Zyxel Device acts like a beacon and regularly broadcasts the SSID in the area. You can hide the SSID instead, in which case the Zyxel Device does not broadcast the SSID. In addition, you should change the default SSID to something that is difficult to guess.

This type of security is fairly weak, however, because there are ways for unauthorized WiFi devices to get the SSID. In addition, unauthorized WiFi devices can still see the information that is sent in the WiFi network.

9.11.3.2 MAC Address Filter

Every device that can use a WiFi network has a unique identification number, called a MAC address.¹ A MAC address is usually written using twelve hexadecimal characters²; for example, 00A0C5000002 or 00:A0:C5:00:00:02. To get the MAC address for each device in the WiFi network, see the device's User's Guide or other documentation.

You can use the MAC address filter to tell the Zyxel Device which devices are allowed or not allowed to use the WiFi network. If a device is allowed to use the WiFi network, it still has to have the correct information (SSID, channel, and security). If a device is not allowed to use the WiFi network, it does not matter if it has the correct information.

This type of security does not protect the information that is sent in the WiFi network. Furthermore, there are ways for unauthorized WiFi devices to get the MAC address of an authorized device. Then, they can use that MAC address to use the WiFi network.

9.11.3.3 Encryption

WiFi networks can use encryption to protect the information that is sent in the WiFi network. Encryption is like a secret code. If you do not know the secret code, you cannot understand the message.

The types of encryption you can choose depend on the type of authentication. (See [Section 9.11.3.3 on page 137](#) for information about this.)

-
1. Some wireless devices, such as scanners, can detect WiFi networks but cannot use WiFi networks. These kinds of wireless devices might not have MAC addresses.
 2. Hexadecimal characters are 0, 1, 2, 3, 4, 5, 6, 7, 8, 9, A, B, C, D, E, and F.

Table 46 Types of Encryption for Each Type of Authentication

	NO AUTHENTICATION	RADIUS SERVER
Weakest	No Security	WPA
↑ ↓	WPA-PSK	WPA2
	WPA2	
Strongest	WPA3-SAE	WPA3 (server certificate validation)

For example, if the WiFi network has a RADIUS server, you can choose **WPA**, **WPA2**, or **WPA3**. If users do not log in to the WiFi network, you can choose no encryption, **WPA2-PSK**, or **WPA3-SAE**.

Note: It is recommended that WiFi networks use **WPA3-SAE**, **WPA2-PSK**, or stronger encryption. The other types of encryption are better than none at all, but it is still possible for unauthorized WiFi devices to figure out the original information pretty quickly.

Many types of encryption use a key to protect the information in the WiFi network. The longer the key, the stronger the encryption. Every device in the WiFi network must have the same key.

9.11.4 Signal Problems

Because WiFi networks are radio networks, their signals are subject to limitations of distance, interference and absorption.

Problems with distance occur when the two radios are too far apart. Problems with interference occur when other radio waves interrupt the data signal. Interference may come from other radio transmissions, such as military or air traffic control communications, or from machines that are coincidental emitters such as electric motors or microwaves. Problems with absorption occur when physical objects (such as thick walls) are between the two radios, muffling the signal.

9.11.5 BSS

A Basic Service Set (BSS) exists when all communications between wireless stations go through one access point (AP).

Intra-BSS traffic is traffic between wireless stations in the BSS. When Intra-BSS traffic blocking is disabled, wireless station A and B can access the wired network and communicate with each other. When Intra-BSS traffic blocking is enabled, wireless station A and B can still access the wired network but cannot communicate with each other.

Figure 77 Basic Service Set

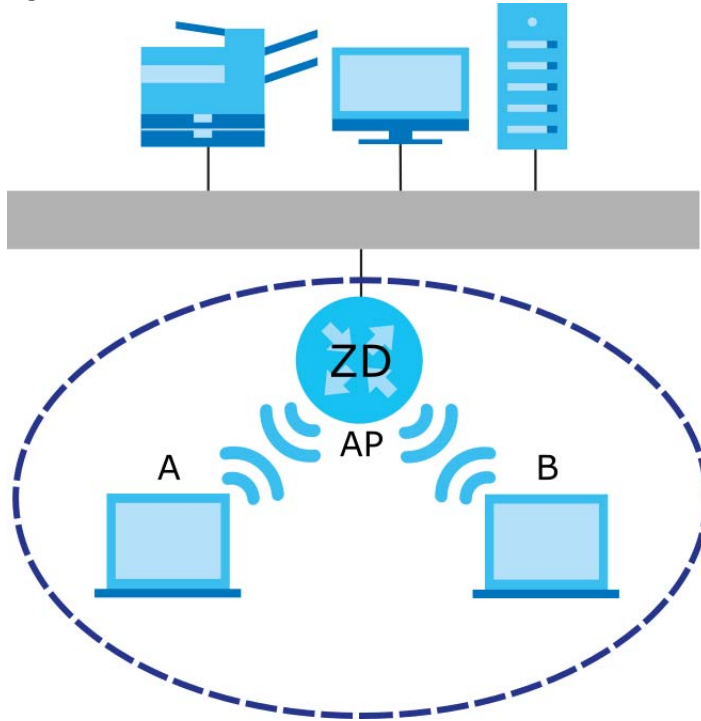

9.11.6 MBSSID

Traditionally, you need to use different APs to configure different Basic Service Sets (BSSs). As well as the cost of buying extra APs, there is also the possibility of channel interference. The Zyxel Device's MBSSID (Multiple Basic Service Set Identifier) function allows you to use one access point to provide several BSSs simultaneously. You can then assign varying QoS priorities and/or security modes to different SSIDs.

Wireless devices can use different BSSIDs to associate with the same AP.

9.11.6.1 Notes on Multiple BSSs

- A maximum of eight BSSs are allowed on one AP simultaneously.
- You must use different keys for different BSSs. If two wireless devices have different BSSIDs (they are in different BSSs), but have the same keys, they may hear each other's communications (but not communicate with each other).
- MBSSID should not replace but rather be used in conjunction with 802.1x security.

9.11.7 Preamble Type

Preamble is used to signal that data is coming to the receiver. Short and long refer to the length of the synchronization field in a packet.

Short preamble increases performance as less time sending preamble means more time for sending data. All IEEE 802.11 compliant WiFi adapters support long preamble, but not all support short preamble.

Use long preamble if you are unsure what preamble mode other WiFi devices on the network support, and to provide more reliable communications in busy WiFi networks.

Use short preamble if you are sure all WiFi devices on the network support it, and to provide more efficient communications.

Use the dynamic setting to automatically use short preamble when all WiFi devices on the network support it, otherwise the Zyxel Device uses long preamble.

Note: The WiFi devices **MUST** use the same preamble mode in order to communicate.

9.11.8 WiFi Protected Setup (WPS)

Your Zyxel Device supports WiFi Protected Setup (WPS), which is an easy way to set up a secure WiFi network. WPS is an industry standard specification, defined by the WiFi Alliance.

WPS allows you to quickly set up a WiFi network with strong security, without having to configure security settings manually. Each WPS connection works between two devices. Both devices must support WPS (check each device's documentation to make sure).

Depending on the devices you have, you can either press a button (on the device itself, or in its configuration utility) or enter a PIN (a unique Personal Identification Number that allows one device to authenticate the other) in each of the two devices. When WPS is activated on a device, it has 2 minutes to find another device that also has WPS activated. Then, the two devices connect and set up a secure network by themselves.

9.11.8.1 Push Button Configuration

WPS Push Button Configuration (PBC) is initiated by pressing a button on each WPS-enabled device, and allowing them to connect automatically. You do not need to enter any information.

Not every WPS-enabled device has a physical WPS button. Some may have a WPS PBC button in their configuration utilities instead of or in addition to the physical button.

Take the following steps to set up WPS using the button.

- 1 Ensure that the two devices you want to set up are within WiFi range of one another.
- 2 Look for a WPS button on each device. If the device does not have one, log into its configuration utility and locate the button (see the device's User's Guide for how to do this – for the Zyxel Device, see [Section 9.5 on page 128](#)).
- 3 Press the button on one of the devices (it doesn't matter which). For the Zyxel Device you must press the **WiFi** button for more than 5 seconds.
- 4 Within 2 minutes, press the button on the other device. The registrar sends the network name (SSID) and security key through a secure connection to the enrollee.

If you need to make sure that WPS worked, check the list of associated WiFi clients in the AP's configuration utility. If you see the WiFi client in the list, WPS was successful.

9.11.8.2 How WPS Works

When two WPS-enabled devices connect, each device must assume a specific role. One device acts as the registrar (the device that supplies network and security settings) and the other device acts as the enrollee (the device that receives network and security settings). The registrar creates a secure EAP (Extensible Authentication Protocol) tunnel and sends the network name (SSID) and the WPA-PSK or

WPA2-PSK pre-shared key to the enrollee. Whether WPA-PSK or WPA2-PSK is used depends on the standards supported by the devices. If the registrar is already part of a network, it sends the existing information. If not, it generates the SSID and WPA2-PSK randomly.

The following figure shows a WPS-enabled client (installed in a notebook computer) connecting to a WPS-enabled access point.

Figure 78 How WPS Works

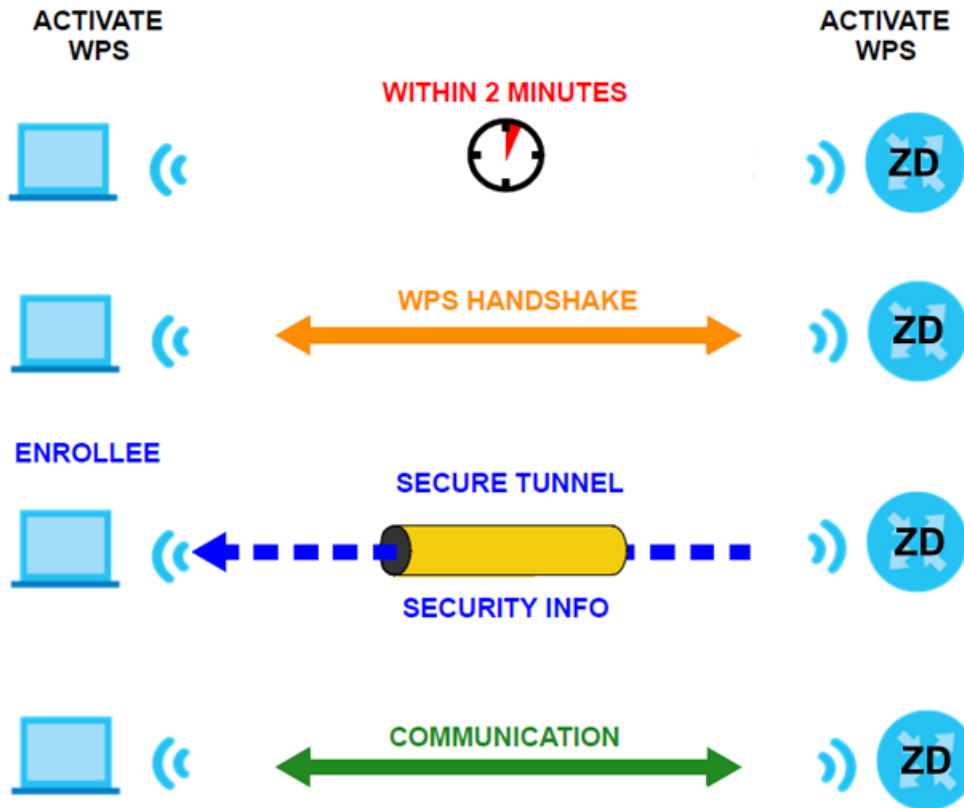

The roles of registrar and enrollee last only as long as the WPS setup process is active (2 minutes). The next time you use WPS, a different device can be the registrar if necessary.

The WPS connection process is like a handshake; only two devices participate in each WPS transaction. If you want to add more devices you should repeat the process with one of the existing networked devices and the new device.

Note that the access point (AP) is not always the registrar, and the WiFi client is not always the enrollee. All WPS-certified APs can be a registrar, and so can some WPS-enabled WiFi clients.

By default, a WPS device is 'un-configured'. This means that it is not part of an existing network and can act as either enrollee or registrar (if it supports both functions). If the registrar is un-configured, the security settings it transmits to the enrollee are randomly-generated. Once a WPS-enabled device has connected to another device using WPS, it becomes 'configured'. A configured WiFi client can still act as enrollee or registrar in subsequent WPS connections, but a configured access point can no longer act as enrollee. It will be the registrar in all subsequent WPS connections in which it is involved. If you want a configured AP to act as an enrollee, you must reset it to its factory defaults.

9.11.8.3 Example WPS Network Setup

This section shows how security settings are distributed in a sample WPS setup.

The following figure shows a sample network. In step 1, both **AP1** and **Client 1** are un-configured. When WPS is activated on both, they perform the handshake. In this example, **AP1** is the registrar, and **Client 1** is the enrollee. The registrar randomly generates the security information to set up the network, since it is un-configured and has no existing information.

Figure 79 WPS: Example Network Step 1



In step 2, you add another WiFi client to the network. You know that **Client 1** supports registrar mode, but it is better to use **AP1** for the WPS handshake with the new client since you must connect to the access point anyway in order to use the network. In this case, **AP1** must be the registrar, since it is configured (it already has security information for the network). **AP1** supplies the existing security information to **Client 2**.

Figure 80 WPS: Example Network Step 2

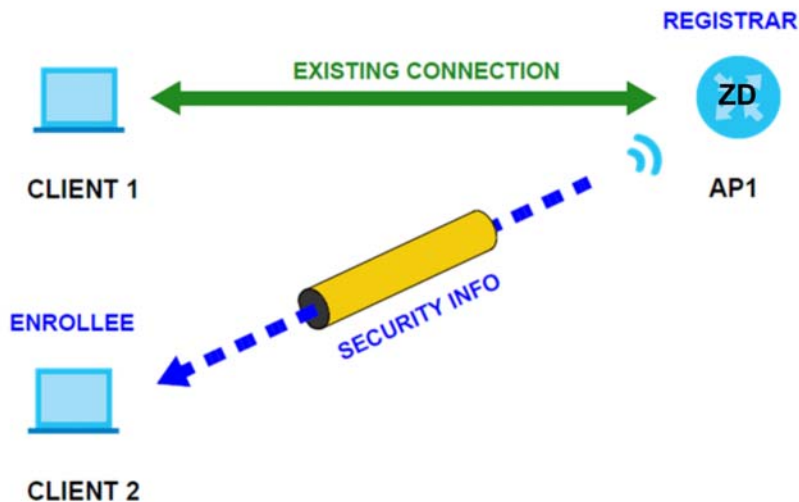

In step 3, you add another access point (**AP2**) to your network. **AP2** is out of range of **AP1**, so you cannot use **AP1** for the WPS handshake with the new access point. However, you know that **Client 2** supports the registrar function, so you use it to perform the WPS handshake instead.

Figure 81 WPS: Example Network Step 3

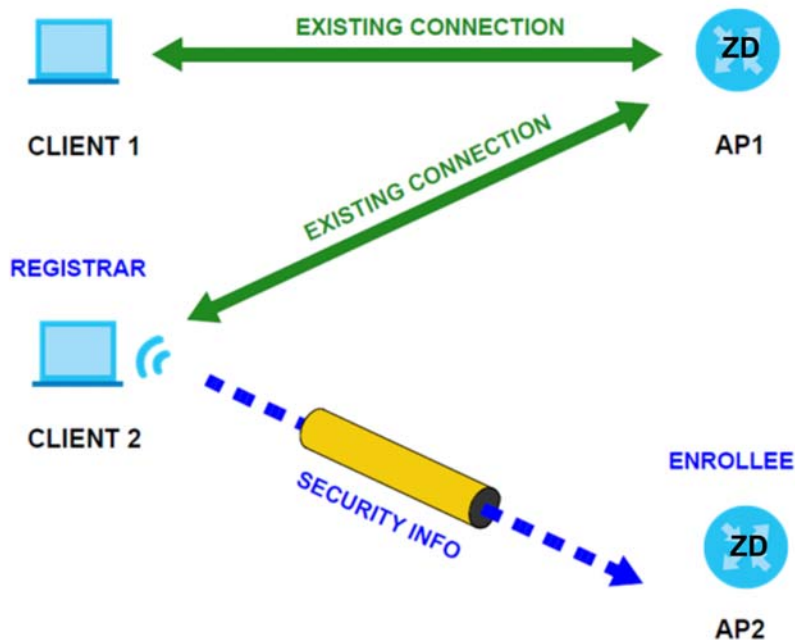

9.11.8.4 Limitations of WPS

WPS has some limitations of which you should be aware.

- When you use WPS, it works between two devices only. You cannot enroll multiple devices simultaneously, you must enroll one after the other.

For instance, if you have two enrollees and one registrar you must set up the first enrollee (by pressing the WPS button on the registrar and the first enrollee, for example), then check that it was successfully enrolled, then set up the second device in the same way.

- WPS works only with other WPS-enabled devices. However, you can still add non-WPS devices to a network you already set up using WPS.

WPS works by automatically issuing a randomly-generated WPA-PSK or WPA2-PSK pre-shared key from the registrar device to the enrollee devices. Whether the network uses WPA-PSK or WPA2-PSK depends on the device. You can check the configuration interface of the registrar device to discover the key the network is using (if the device supports this feature). Then, you can enter the key into the non-WPS device and join the network as normal (the non-WPS device must also support WPA-PSK or WPA2-PSK).

- When you use the PBC method, there is a short period (from the moment you press the button on one device to the moment you press the button on the other device) when any WPS-enabled device could join the network. This is because the registrar has no way of identifying the 'correct' enrollee, and cannot differentiate between your enrollee and a rogue device. This is a possible way for a hacker to gain access to a network.

You can easily check to see if this has happened. WPS only works simultaneously between two devices, so if another device has enrolled your device will be unable to enroll, and will not have access to the network. If this happens, open the access point's configuration interface and look at the list of associated clients (usually displayed by MAC address). It does not matter if the access point is the WPS registrar, the enrollee, or was not involved in the WPS handshake; a rogue device must still associate with the access point to gain access to the network. Check the MAC addresses of your WiFi clients (usually printed on a label on the bottom of the device). If there is an unknown MAC address you can remove it or reset the AP.

CHAPTER 10

Home Networking

10.1 Home Networking Overview

A Local Area Network (LAN) is a shared communication system to which many computers are attached. A LAN is usually located in one immediate area such as a building or floor of a building.

The LAN screens can help you configure a LAN DHCP server and manage IP addresses.

Figure 82 Home Networking Example

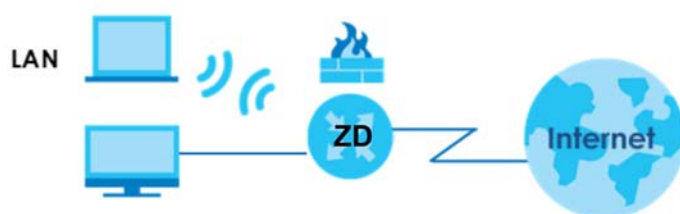

10.1.1 What You Can Do in this Chapter

- Use the **LAN Setup** screen to set the LAN IP address, subnet mask, and DHCP settings ([Section 10.2 on page 146](#)).
- Use the **Static DHCP** screen to assign IP addresses on the LAN to specific individual computers based on their MAC addresses ([Section 10.3 on page 150](#)).
- Use the **UPnP** screen to enable UPnP ([Section 10.4 on page 152](#)).
- Use the **Additional Subnet** screen to configure IP alias and public static IP ([Section 10.5 on page 153](#)).
- Use the **Wake on LAN** screen to remotely turn on a device on the network. ([Section 10.6 on page 155](#)).
- Use the **TFTP Server Name** screen to identify a TFTP server for configuration file download using DHCP option 66. ([Section 10.7 on page 156](#)).

10.1.2 What You Need To Know

The following terms and concepts may help as you read this chapter.

10.1.2.1 About LAN

IP Address

Similar to the way houses on a street share a common street name, so too do computers on a LAN share one common network number. This is known as an Internet Protocol address.

Subnet Mask

The subnet mask specifies the network number portion of an IP address. Your Zyxel Device will compute the subnet mask automatically based on the IP address that you entered. You do not need to change the subnet mask computed by the Zyxel Device unless you are instructed to do otherwise.

DHCP

DHCP (Dynamic Host Configuration Protocol) allows clients to obtain TCP/IP configuration at start-up from a server. This Zyxel Device has a built-in DHCP server capability that assigns IP addresses and DNS servers to systems that support DHCP client capability.

DNS

DNS (Domain Name System) maps a domain name to its corresponding IP address and vice versa. The DNS server is extremely important because without it, you must know the IP address of a computer before you can access it. The DNS server addresses you enter when you set up DHCP are passed to the client machines along with the assigned IP address and subnet mask.

RADVD (Router Advertisement Daemon)

When an IPv6 host sends a Router Solicitation (RS) request to discover the available routers, RADVD with Router Advertisement (RA) messages in response to the request. It specifies the minimum and maximum intervals of RA broadcasts. RA messages containing the address prefix. IPv6 hosts can be generated with the IPv6 prefix an IPv6 address.

10.1.2.2 About UPnP

How do I know if I am using UPnP?

UPnP hardware is identified as an icon in the Network Connections folder (Windows 7). Each UPnP compatible device installed on your network will appear as a separate icon. Selecting the icon of a UPnP device will allow you to access the information and properties of that device.

NAT Traversal

UPnP NAT traversal automates the process of allowing an application to operate through NAT. UPnP network devices can automatically configure network addressing, announce their presence in the network to other UPnP devices and enable exchange of simple product and service descriptions. NAT traversal allows the following:

- Dynamic port mapping
- Learning public IP addresses
- Assigning lease times to mappings

Windows Messenger is an example of an application that supports NAT traversal and UPnP.

Cautions with UPnP

The automated nature of NAT traversal applications in establishing their own services and opening firewall ports may present network security issues. Network information and configuration may also be obtained and modified by users in some network environments.

When a UPnP device joins a network, it announces its presence with a multicast message. For security reasons, the Zyxel Device allows multicast messages on the LAN only.

All UPnP-enabled devices may communicate freely with each other without additional configuration. Disable UPnP if this is not your intention.

UPnP and Zyxel

Zyxel has achieved UPnP certification from the Universal Plug and Play Forum UPnP™ Implementers Corp. (UIC).

See [Section 10.9 on page 159](#) for examples on installing and using UPnP.

10.1.3 Before You Begin

Find out the MAC addresses of your network devices if you intend to add them to the DHCP Client List screen.

10.2 LAN Setup

A LAN IP address is the IP address of a networking device in the LAN. You can use the Zyxel Device's LAN IP address to access its Web Configurator from the LAN. The DHCP server settings define the rules on assigning IP addresses to LAN clients on your network.

Use this screen to set the Local Area Network IP address and subnet mask of your Zyxel Device. Configure DHCP settings to have the Zyxel Device or a DHCP server assign IP addresses to devices. Click **Network Setting > Home Networking** to open the **LAN Setup** screen.

Follow these steps to configure your LAN settings.

- 1 Enter an IP address into the **IP Address** field. The IP address must be in dotted decimal notation. This will become the IP address of your Zyxel Device.
- 2 Enter the IP subnet mask into the **IP Subnet Mask** field. Unless instructed otherwise it is best to leave this alone, the configurator will automatically compute a subnet mask based upon the IP address you entered.
- 3 Click **Apply** to save your settings.

Figure 83 Network Setting > Home Networking > LAN Setup

The LAN IP address is the IP address you use to log into the web configurator. The DHCP server settings define the rules on how to assign IP addresses to the LAN clients on your network.

Interface Group
Group Name:

LAN IP Setup
IP Address:
Subnet Mask:

DHCP Server State
DHCP: Enable Disable DHCP Relay

IP Addressing Values
Beginning IP Address:
Ending IP Address:
Auto reserve IP for the same host:

DHCP Server Lease Time
 days hours minutes

DNS Values
DNS: DNS Proxy Static From ISP

LAN IPv6 Mode Setup
IPv6 Active:

Link Local Address Type
 EUI64
 Manual

LAN Global Identifier Type
 EUI64
 Manual

LAN IPv6 Prefix Setup
 Delegate prefix from WAN
 Static

LAN IPv6 Address Assign Setup

LAN IPv6 DNS Assign Setup

DHCPv6 Configuration
DHCPv6 Active: DHCPv6 Server:

IPv6 Router Advertisement State
RA/DVD Active: Enable:

IPv6 DNS Values
IPv6 DNS Server 1:
IPv6 DNS Server 2:
IPv6 DNS Server 3:

DNS Query Scenario

The following table describes the fields in this screen.

Table 47 Network Setting > Home Networking > LAN Setup

LABEL	DESCRIPTION
Interface Group	
Group Name	This displays the name of the group that your Zyxel Device belongs to.
LAN IP Setup	
IP Address	Enter the LAN IP address you want to assign to your Zyxel Device in dotted decimal notation, for example, 192.168.123.1 (factory default).
Subnet Mask	Type the subnet mask of your network in dotted decimal notation, for example 255.255.255.0 (factory default). Your Zyxel Device automatically computes the subnet mask based on the IP address you enter, so do not change this field unless you are instructed to do so.
DHCP Server State	
DHCP	<p>Select Enable to have your Zyxel Device assign IP addresses, an IP default gateway and DNS servers to LAN computers and other devices that are DHCP clients.</p> <p>If you select Disable, you need to manually configure the IP addresses of the computers and other devices on your LAN.</p> <p>If you select DHCP Relay, the Zyxel Device acts as a surrogate DHCP server and relays DHCP requests and responses between the remote server and the clients.</p> <p>When DHCP is used, the following fields need to be set:</p>
IP Addressing Values	
The IP Addressing Values fields appear only when you select Enable in the DHCP field.	
Beginning IP Address	This field specifies the first of the contiguous addresses in the IP address pool.
Ending IP Address	This field specifies the last of the contiguous addresses in the IP address pool.
Auto reserve IP for the same host	Enable this if you want to reserve the IP address for the same host.
DHCP Server Lease Time	
<p>This is the period of time DHCP-assigned addresses is used. DHCP automatically assigns IP addresses to clients when they log in. DHCP centralizes IP address management on central computers that run the DHCP server program. DHCP leases addresses, for a period of time, which means that past addresses are "recycled" and made available for future reassignment to other systems.</p> <p>This field is only available when you select Enable in the DHCP field.</p>	
Days/Hours/Minutes	DHCP server leases an address to a new device for a period of time, called the DHCP lease time. When the lease expires, the DHCP server might assign the IP address to a different device.
DNS Values	
This field appears only when you select Enable in the DHCP field.	
DNS	<p>The Zyxel Device supports DNS proxy by default. The Zyxel Device sends out its own LAN IP address to the DHCP clients as the first DNS server address. DHCP clients use this first DNS server to send domain-name queries to the Zyxel Device. The Zyxel Device sends a response directly if it has a record of the domain-name to IP address mapping. If it does not, the Zyxel Device queries an outside DNS server and relays the response to the DHCP client.</p> <p>Select DNS Proxy to have the DHCP clients use the Zyxel Device's own LAN IP address. The Zyxel Device works as a DNS relay.</p> <p>Select Static if you have the IP address of a DNS server. Enter the DNS server's IP address in the field to the right.</p> <p>Select From ISP if your ISP dynamically assigns DNS server information (and the Zyxel Device's WAN IP address).</p>

Table 47 Network Setting > Home Networking > LAN Setup (continued)

LABEL	DESCRIPTION						
LAN IPv6 Mode Setup							
IPv6 Active	Use this to enable or disable IPv6 activation on the Zyxel Device. When IPv6 activation is used, the following fields need to be set.						
Link Local Address Type	<p>A link-local address uniquely identifies a device on the local network (the LAN). It is similar to a "private IP address" in IPv6. You can have the same link-local address on multiple interfaces on a device. A link-local unicast address has a predefined prefix of fe80::/10. The link-local unicast address format is as follows. Select EUI64 to allow the Zyxel Device to generate an interface ID for the LAN interface's link-local address using the EUI-64 format. Otherwise, enter an interface ID for the LAN interface's link-local address if you select Manual.</p> <p>Link-local Unicast Address Format</p> <table border="1"> <tr> <td>1111 1110 10</td> <td>0</td> <td>Interface ID</td> </tr> <tr> <td>10 bits</td> <td>54 bits</td> <td>64 bits</td> </tr> </table>	1111 1110 10	0	Interface ID	10 bits	54 bits	64 bits
1111 1110 10	0	Interface ID					
10 bits	54 bits	64 bits					
EUI64	Select this to have the Zyxel Device generate an interface ID for the LAN interface's link-local address using the EUI-64 format.						
Manual	Select this to manually enter an interface ID for the LAN interface's link-local address.						
LAN Global Identifier Type	Select EUI64 to have the Zyxel Device generate an interface ID using the EUI-64 format for its global address. Select Manual to manually enter an interface ID for the LAN interface's global IPv6 address.						
EUI64	Select this to have the Zyxel Device generate an interface ID using the EUI-64 format for its global address.						
Manual	Select this to manually enter an interface ID for the LAN interface's global IPv6 address.						
LAN IPv6 Prefix Setup	Select Delegate prefix from WAN to automatically obtain an IPv6 network prefix from the service provider or an uplink router. Select Static to configure a fixed IPv6 address for the Zyxel Device's LAN IPv6 address.						
Delegate prefix from WAN	Select this option to automatically obtain an IPv6 network prefix from the service provider or an uplink router.						
Static	Select this option to configure a fixed IPv6 address for the Zyxel Device's LAN IPv6 address.						
LAN IPv6 Address Assign Setup	<p>Select how you want to obtain an IPv6 address:</p> <p>Stateless: The Zyxel Device uses IPv6 stateless auto-configuration. RADVD (Router Advertisement Daemon) is enabled to have the Zyxel Device send IPv6 prefix information in router advertisements periodically and in response to router solicitations. DHCPv6 server is disabled.</p> <p>Stateful: The Zyxel Device uses IPv6 stateful auto-configuration. The DHCPv6 server is enabled to have the Zyxel Device act as a DHCPv6 server and pass IPv6 addresses to DHCPv6 clients.</p>						
LAN IPv6 DNS Assign Setup	<p>Select how the Zyxel Device provide DNS server and domain name information to the clients:</p> <p>From RA & DHCPv6 Server: The Zyxel Device provides DNS information through both router advertisements and DHCPv6.</p> <p>From DHCPv6 Server: The Zyxel Device provides DNS information through DHCPv6.</p> <p>From Router Advertisement: The Zyxel Device provides DNS information through router advertisements.</p>						
DHCPv6 Configuration							
DHCPv6 Active	This shows the status of the DHCPv6. DHCP Server displays if you configured the Zyxel Device to act as a DHCPv6 server which assigns IPv6 addresses and/or DNS information to clients.						
IPv6 Router Advertisement State							

Table 47 Network Setting > Home Networking > LAN Setup (continued)

LABEL	DESCRIPTION
RADVD Active	This shows whether RADVD is enabled or not.
IPv6 DNS Values	
IPv6 DNS Server 1 – 3	<p>Specify the IP addresses up to three DNS servers for the DHCP clients to use. Use one of the following ways to specify these IP addresses.</p> <p>User Defined – Select this if you have the IPv6 address of a DNS server. Enter the DNS server IPv6 addresses the Zyxel Device passes to the DHCP clients.</p> <p>From ISP – Select this if your ISP dynamically assigns IPv6 DNS server information.</p> <p>Proxy – Select this if the DHCP clients use the IP address of this interface and the Zyxel Device works as a DNS relay.</p> <p>Otherwise, select None if you do not want to configure IPv6 DNS servers.</p>
DNS Query Scenario	<p>Select how the Zyxel Device handles clients' DNS information requests.</p> <p>IPv4/IPv6 DNS Server: The Zyxel Device forwards the requests to both the IPv4 and IPv6 DNS servers and sends clients the first DNS information it receives.</p> <p>IPv6 DNS Server Only: The Zyxel Device forwards the requests to the IPv6 DNS server and sends clients the DNS information it receives.</p> <p>IPv4 DNS Server Only: The Zyxel Device forwards the requests to the IPv4 DNS server and sends clients the DNS information it receives.</p> <p>IPv6 DNS Server First: The Zyxel Device forwards the requests to the IPv6 DNS server first and then the IPv4 DNS server. Then it sends clients the first DNS information it receives.</p> <p>IPv4 DNS Server First: The Zyxel Device forwards the requests to the IPv4 DNS server first and then the IPv6 DNS server. Then it sends clients the first DNS information it receives.</p>
Apply	Click Apply to save your changes.
Cancel	Click Cancel to restore your previously saved settings.

10.3 Static DHCP

When any of the LAN clients in your network want an assigned fixed IP address, add a static lease for each LAN client. Knowing the LAN client's MAC addresses is necessary. This table allows you to assign IP addresses on the LAN to individual computers based on their MAC addresses.

Every Ethernet device has a unique MAC (Media Access Control) address. The MAC address is assigned at the factory and consists of six pairs of hexadecimal characters, for example, 00:A0:C5:00:00:02.

10.3.1 Before You Begin

Find out the MAC addresses of your network devices if you intend to add them to the **Static DHCP** screen.

Use this screen to change your Zyxel Device's static DHCP settings. Click **Network Setting > Home Networking > Static DHCP** to open the following screen.

Figure 84 Network Setting > Home Networking > Static DHCP

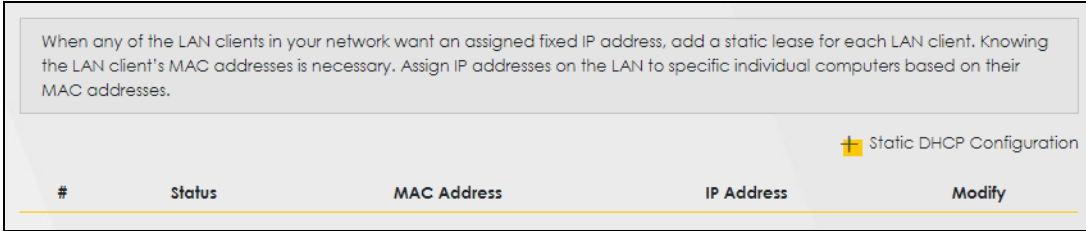

The following table describes the labels in this screen.

Table 48 Network Setting > Home Networking > Static DHCP

LABEL	DESCRIPTION
Static DHCP Configuration	Click this to configure a static DHCP entry.
#	This is the index number of the entry.
Status	This field displays whether the client is connected to the Zyxel Device.
MAC Address	The MAC (Media Access Control) or Ethernet address on a LAN (Local Area Network) is unique to your computer (six pairs of hexadecimal notation). A network interface card such as an Ethernet adapter has a hardwired address that is assigned at the factory. This address follows an industry standard that ensures no other adapter has a similar address.
IP Address	This field displays the IP address relative to the # field listed above.
Modify	Click the Edit icon to configure the connection. Click the Delete icon to remove the connection.

If you click **Static DHCP Configuration** in the **Static DHCP** screen, the following screen displays. Using a static DHCP means a client will always have the same IP address assigned to it by the DHCP server. Assign a fixed IP address to a device by selecting the interface group of this device and its IP address type and selecting the device/computer from a list or manually entering its MAC address and assigned IP address.

Figure 85 Network Setting > Home Networking > Static DHCP: Static DHCP Configuration

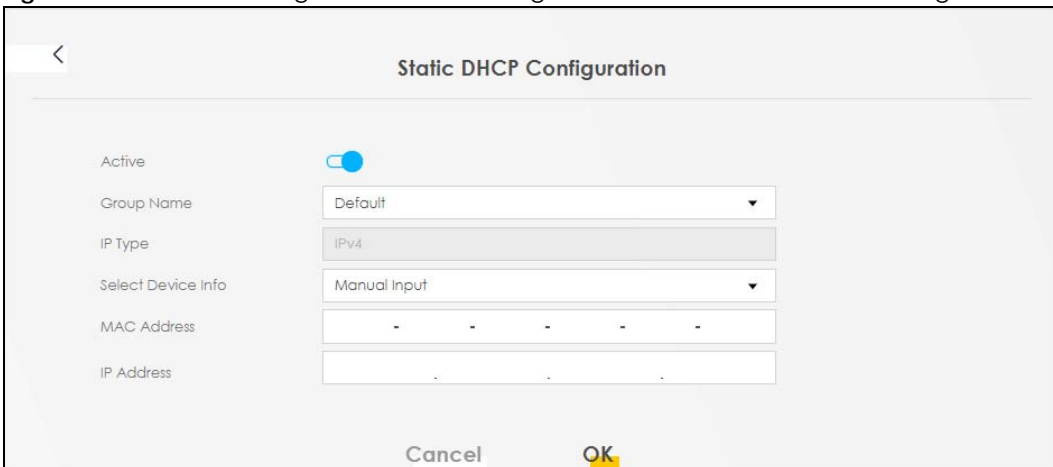

The following table describes the labels in this screen.

Table 49 Network Setting > Home Networking > Static DHCP: Static DHCP Configuration

LABEL	DESCRIPTION
Active	Select Enable to activate static DHCP in your Zyxel Device.
Group Name	The Group Name is normally Default .
IP Type	The IP Type is normally IPv4 (non-configurable).
Select Device Info	Select between Manual Input which allows you to enter the next two fields (MAC Address and IP Address); or selecting an existing device would show its MAC address and IP address.
MAC Address	Enter the MAC address of a computer on your LAN if you select Manual Input in the previous field.
IP Address	Enter the IP address that you want to assign to the computer on your LAN with the MAC address that you will also specify if you select Manual Input in the previous field.
OK	Click OK to save your changes.
Cancel	Click Cancel to exit this screen without saving.

10.4 UPnP

Universal Plug and Play (UPnP) is an open networking standard that uses TCP/IP for simple peer-to-peer network connectivity between networking devices or software applications which have UPnP enabled. A UPnP device can dynamically join a network, obtain an IP address, advertise its services, and learn about other devices on the network. A device can also leave a network automatically when it is no longer in use.

See [Section 10.9 on page 159](#) for more information on UPnP.

Note: To use **UPnP NAT-T**, enable **NAT** in the **Network Setting > Broadband > Edit or Add New WAN Interface** screen.

Use the following screen to configure the UPnP settings on your Zyxel Device. Click **Network Setting > Home Networking > UPnP** to display the screen shown next.

Figure 86 Network Setting > Home Networking > UPnP

Universal Plug and Play (UPnP) is a distributed, open networking standard that uses TCP/IP for simple peer-to-peer network connectivity between networking devices and software that also have UPnP enabled. A UPnP device can dynamically join a network, obtain an IP address, convey its capabilities and learn about other devices on the network. A device can leave a network smoothly and automatically when it is no longer in use.

UPnP State

UPnP

UPnP NAT-T State

UPnP NAT-T

Note
UPnP NAT-T only works when NAT is enable

#	Description	Destination IP Address	External Port	Internal Port	Protocol
<input type="button" value="Cancel"/> <input checked="" type="button" value="Apply"/>					

The following table describes the labels in this screen.

Table 50 Network Settings > Home Networking > UPnP

LABEL	DESCRIPTION
UPnP State	
UPnP	Select Enable to activate UPnP. Be aware that anyone could use a UPnP application to open the Web Configurator's login screen without entering the Zyxel Device's IP address (although you must still enter the password to access the Web Configurator).
UPnP NAT-T State	
UPnP NAT-T	Select Enable to activate UPnP with NAT enabled. UPnP NAT traversal automates the process of allowing an application to operate through NAT. UPnP network devices can automatically configure network addressing, announce their presence in the network to other UPnP devices and enable exchange of simple product and service descriptions.
#	This field displays the index number of the entry.
Description	This field displays the description of the UPnP NAT-T connection.
Destination IP Address	This field displays the IP address of the other connected UPnP-enabled device.
External Port	This field displays the external port number that identifies the service.
Internal Port	This field displays the internal port number that identifies the service.
Protocol	This field displays the protocol of the NAT mapping rule. Choices are TCP or UDP .
Apply	Click Apply to save your changes.
Cancel	Click Cancel to restore your previously saved settings.

10.5 LAN Additional Subnet

Use this screen to configure IP alias and public static IP.

IP alias allows you to partition a physical network into different logical networks over the same Ethernet interface. The Zyxel Device supports multiple logical LAN interfaces through its physical Ethernet

interface with the Zyxel Device itself as the gateway for the LAN network. When you use IP alias, you can also configure firewall rules to control access to the LAN's logical network (subnet).

If your ISP provides the **Public LAN** service, the Zyxel Device may use a LAN IP address that can be accessed from the WAN.

Click **Network Setting > Home Networking > Additional Subnet** to display the screen shown next.

Figure 87 Network Setting > Home Networking > Additional Subnet

The following table describes the labels in this screen.

Table 51 Network Setting > Home Networking > Additional Subnet





LABEL	DESCRIPTION
IP Alias Setup	
Group Name	Select the interface group name for which you want to configure the IP alias settings.
Active	Click this switch to configure a LAN network for the Zyxel Device. When the switch goes to the right  , the following fields will be configurable. Otherwise, they are not.
IPv4 Address	Enter the IP address of your Zyxel Device in dotted decimal notation.

Table 51 Network Setting > Home Networking > Additional Subnet (continued)

LABEL	DESCRIPTION
Subnet Mask	Your Zyxel Device will automatically calculate the subnet mask based on the IPv4 address that you assign. Unless you are implementing subnetting, use this value computed by the Zyxel Device.
Public LAN	
Active	Click this switch to enable or disable the Public LAN feature. When the switch goes to the right  , the function is enabled. Otherwise, it is not. Your ISP must support Public LAN and static IP.
IPv4 Address	Enter the public IP address provided by your ISP.
Subnet Mask	Enter the public IPv4 subnet mask provided by your ISP.
Offer Public IP by DHCP	Click this switch to enable or disable the Zyxel Device to provide public IP addresses by DHCP server. When the switch goes to the right  , the function is enabled. Otherwise, it is not.
Enable ARP Proxy	Click this switch to enable or disable the ARP (Address Resolution Protocol) proxy. When the switch goes to the right  , the function is enabled. Otherwise, it is not.
Cancel	Click Cancel to restore your previously saved settings.
Apply	Click Apply to save your changes.

10.6 Wake on LAN

Wake on LAN (WoL) allows you to remotely turn on a device on the network, such as a computer, storage device or media server. To use this feature the remote hardware (for example the network adapter on a computer) must support Wake On LAN using the 'Magic Packet' method.

You need to know the MAC address of the LAN device. It may be on a label on the device or in its documentation.

Click **Network Setting > Home Networking > Wake on LAN** to open this screen.

Figure 88 Network Setting > Home Networking > Wake on LAN

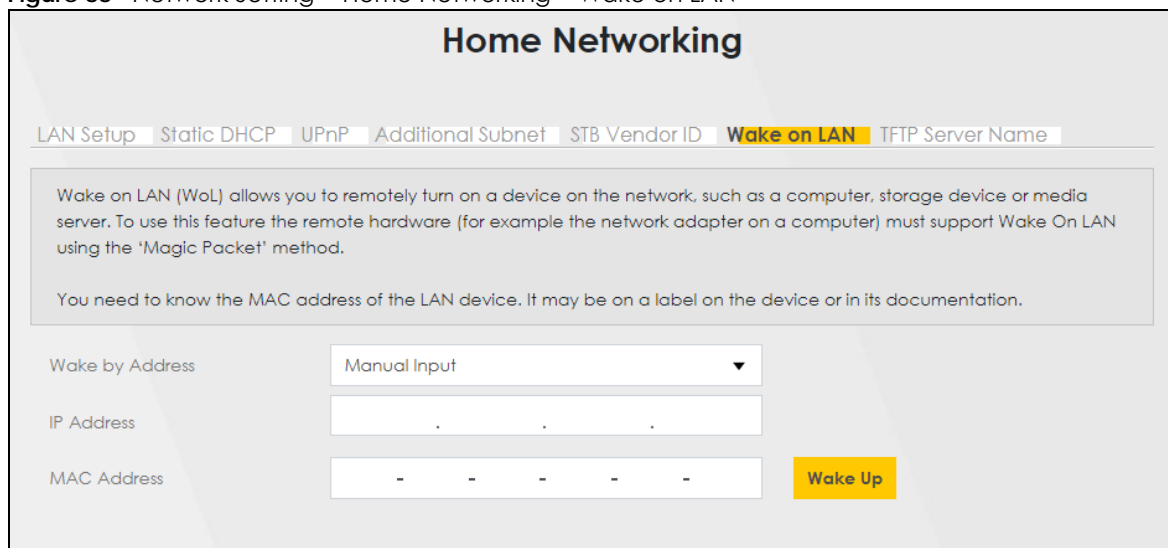

Home Networking

LAN Setup Static DHCP UPnP Additional Subnet **Wake on LAN** TFTP Server Name

Wake on LAN (WoL) allows you to remotely turn on a device on the network, such as a computer, storage device or media server. To use this feature the remote hardware (for example the network adapter on a computer) must support Wake On LAN using the 'Magic Packet' method.

You need to know the MAC address of the LAN device. It may be on a label on the device or in its documentation.

Wake by Address:

IP Address:

MAC Address:

Wake Up

The following table describes the labels in this screen.

Table 52 Network Setting > Home Networking > Wake on LAN

LABEL	DESCRIPTION
Wake by Address	Select Manual and enter the IP address or MAC address of the device to turn it on remotely. The drop-down list also lists the IP addresses that can be found in the Zyxel Device's ARP table. If you select an IP address, the MAC address of the device with the selected IP address then displays in the MAC Address field.
IP Address	Enter the IPv4 IP address of the device to turn it on. This field is not available if you select an IP address in the Wake by Address field.
MAC Address	Enter the MAC address of the device to turn it on. A MAC address consists of six hexadecimal character pairs.
Wake up	Click this to send a WoL magic packet to wake up the specified device.

10.7 TFTP Server Name

Use the **TFTP Server Name** screen to identify a TFTP server for configuration file download using DHCP option 66. RFC 2132 defines the option 66 open standard. DHCP option 66 supports the IP address or the host name of a single TFTP server.

Click **Network Setting > Home Networking > TFTP Server Name** to open this screen.

Figure 89 Network Setting > Home Networking > TFTP Server Name

The following table describes the labels in this screen.

Table 53 Network Setting > Home Networking > TFTP Server Name

LABEL	DESCRIPTION
TFTP Server Name	Enter the IP address or the host name of a single TFTP server.
Cancel	Click Cancel to restore your previously saved settings.
Apply	Click Apply to save your changes.

10.8 Technical Reference

This section provides some technical background information about the topics covered in this chapter.

LANs, WANs and the Zyxel Device

The actual physical connection determines whether the Zyxel Device ports are LAN or WAN ports. There are two separate IP networks, one inside the LAN network and the other outside the WAN network as shown next.

Figure 90 LAN and WAN IP Addresses

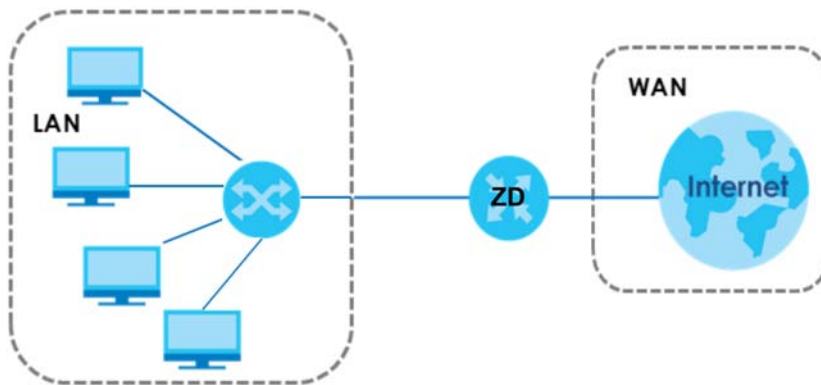

10.8.1 DHCP Setup

DHCP (Dynamic Host Configuration Protocol, RFC 2131 and RFC 2132) allows individual clients to obtain TCP/IP configuration at start-up from a server. You can configure the Zyxel Device as a DHCP server or disable it. When configured as a server, the Zyxel Device provides the TCP/IP configuration for the clients. If you turn DHCP service off, you must have another DHCP server on your LAN, or else the computer must be manually configured.

IP Pool Setup

The Zyxel Device is pre-configured with a pool of IP addresses for the DHCP clients (DHCP Pool). See the product specifications in the appendices. Do not assign static IP addresses from the DHCP pool to your LAN computers.

10.8.2 DNS Server Addresses

DNS (Domain Name System) maps a domain name to its corresponding IP address and vice versa. The DNS server is extremely important because without it, you must know the IP address of a computer before you can access it. The DNS server addresses you enter when you set up DHCP are passed to the client machines along with the assigned IP address and subnet mask.

There are two ways that an ISP disseminates the DNS server addresses.

- The ISP tells you the DNS server addresses, usually in the form of an information sheet, when you sign up. If your ISP gives you DNS server addresses, enter them in the **DNS Server** fields in the **DHCP Setup** screen.

- Some ISPs choose to disseminate the DNS server addresses using the DNS server extensions of IPCP (IP Control Protocol) after the connection is up. If your ISP did not give you explicit DNS servers, chances are the DNS servers are conveyed through IPCP negotiation. The Zyxel Device supports the IPCP DNS server extensions through the DNS proxy feature.

Please note that DNS proxy works only when the ISP uses the IPCP DNS server extensions. It does not mean you can leave the DNS servers out of the DHCP setup under all circumstances. If your ISP gives you explicit DNS servers, make sure that you enter their IP addresses in the **DHCP Setup** screen.

10.8.3 LAN TCP/IP

The Zyxel Device has built-in DHCP server capability that assigns IP addresses and DNS servers to systems that support DHCP client capability.

IP Address and Subnet Mask

Similar to the way houses on a street share a common street name, so too do computers on a LAN share one common network number.

Where you obtain your network number depends on your particular situation. If the ISP or your network administrator assigns you a block of registered IP addresses, follow their instructions in selecting the IP addresses and the subnet mask.

If the ISP did not explicitly give you an IP network number, then most likely you have a single user account and the ISP will assign you a dynamic IP address when the connection is established. If this is the case, it is recommended that you select a network number from 192.168.0.0 to 192.168.255.0 and you must enable the Network Address Translation (NAT) feature of the Zyxel Device. The Internet Assigned Number Authority (IANA) reserved this block of addresses specifically for private use; please do not use any other number unless you are told otherwise. Let's say you select 192.168.1.0 as the network number; which covers 254 individual addresses, from 192.168.1.1 to 192.168.1.254 (zero and 255 are reserved). In other words, the first three numbers specify the network number while the last number identifies an individual computer on that network.

Once you have decided on the network number, pick an IP address that is easy to remember, for instance, 192.168.1.1, for your Zyxel Device, but make sure that no other device on your network is using that IP address.

The subnet mask specifies the network number portion of an IP address. Your Zyxel Device will compute the subnet mask automatically based on the IP address that you entered. You do not need to change the subnet mask computed by the Zyxel Device unless you are instructed to do otherwise.

Private IP Addresses

Every machine on the Internet must have a unique address. If your networks are isolated from the Internet, for example, only between your two branch offices, you can assign any IP addresses to the hosts without problems. However, the Internet Assigned Numbers Authority (IANA) has reserved the following three blocks of IP addresses specifically for private networks:

- 10.0.0.0 — 10.255.255.255
- 172.16.0.0 — 172.31.255.255
- 192.168.0.0 — 192.168.255.255

You can obtain your IP address from the IANA, from an ISP or it can be assigned from a private network. If you belong to a small organization and your Internet access is through an ISP, the ISP can provide you with the Internet addresses for your local networks. On the other hand, if you are part of a much larger organization, you should consult your network administrator for the appropriate IP addresses.

Note: Regardless of your particular situation, do not create an arbitrary IP address; always follow the guidelines above. For more information on address assignment, please refer to RFC 1597, "Address Allocation for Private Internets" and RFC 1466, "Guidelines for Management of IP Address Space".

10.9 Turn on UPnP in Windows 10 Example

This section shows you how to use the UPnP feature in Windows 10. UPnP server is installed in Windows 10. Activate UPnP on the Zyxel Device by clicking **Network Setting > Home Networking > UPnP**.

Make sure the computer is connected to the LAN port of the Zyxel Device. Turn on your computer and the Zyxel Device.

- 1 Click the start icon, **Settings** and then **Network & Internet**.

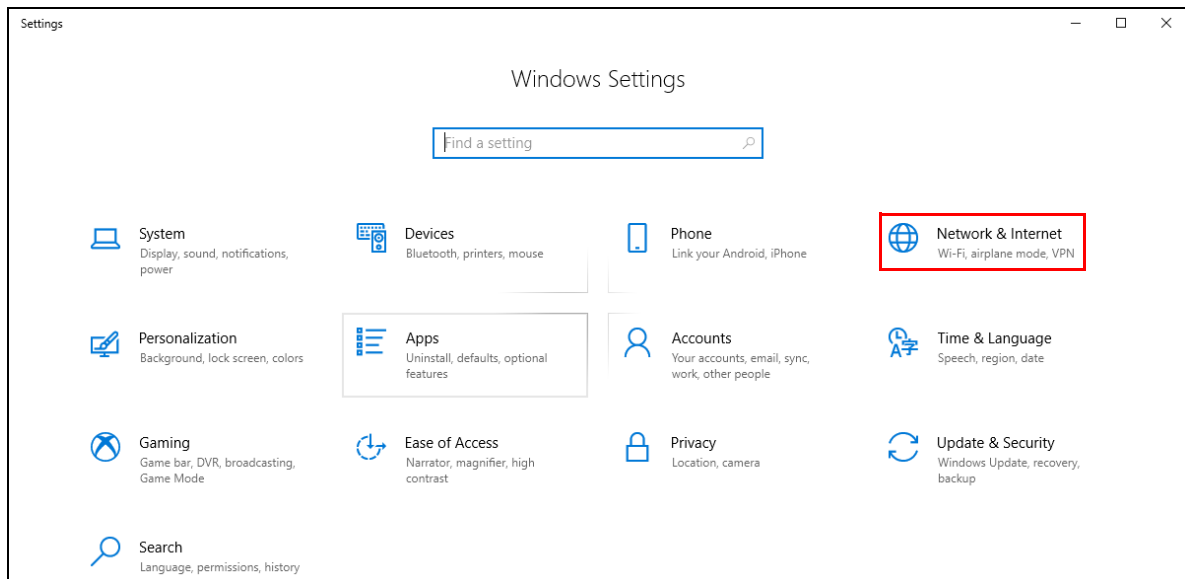

- 2 Click **Network and Sharing Center**.

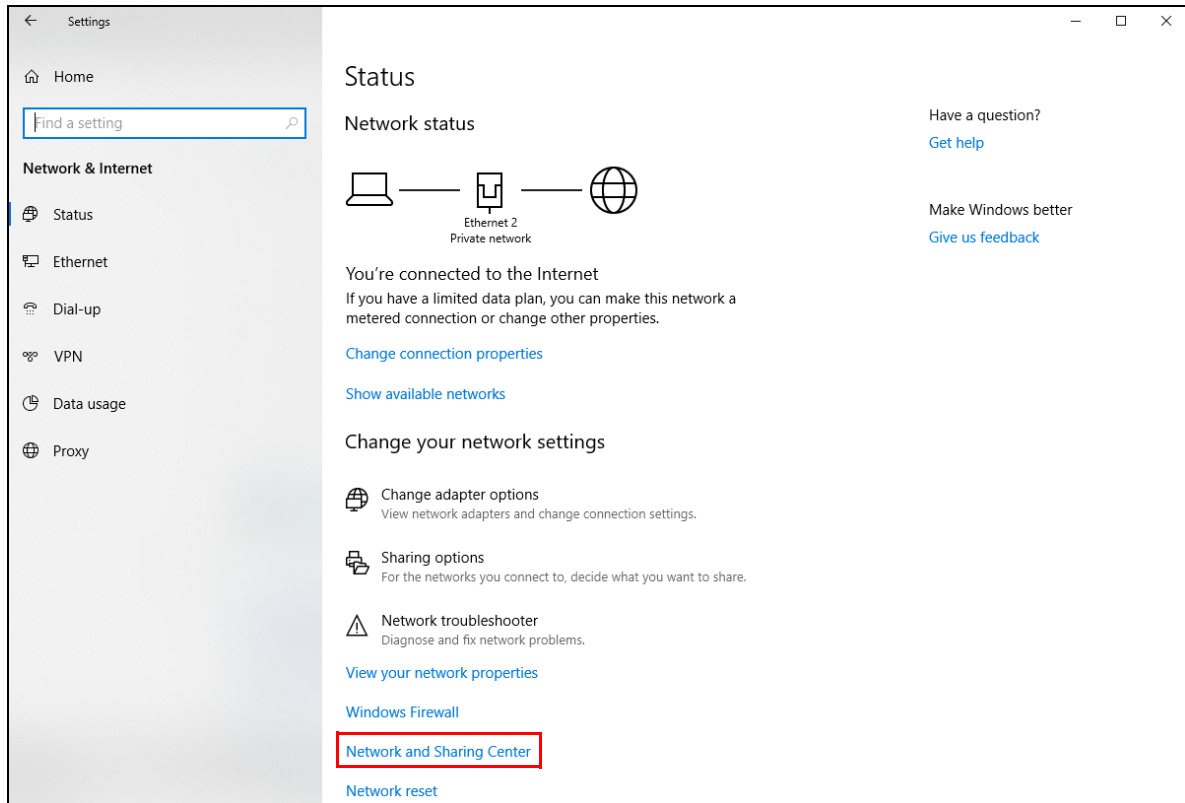

3 Click **Change advanced sharing settings**.

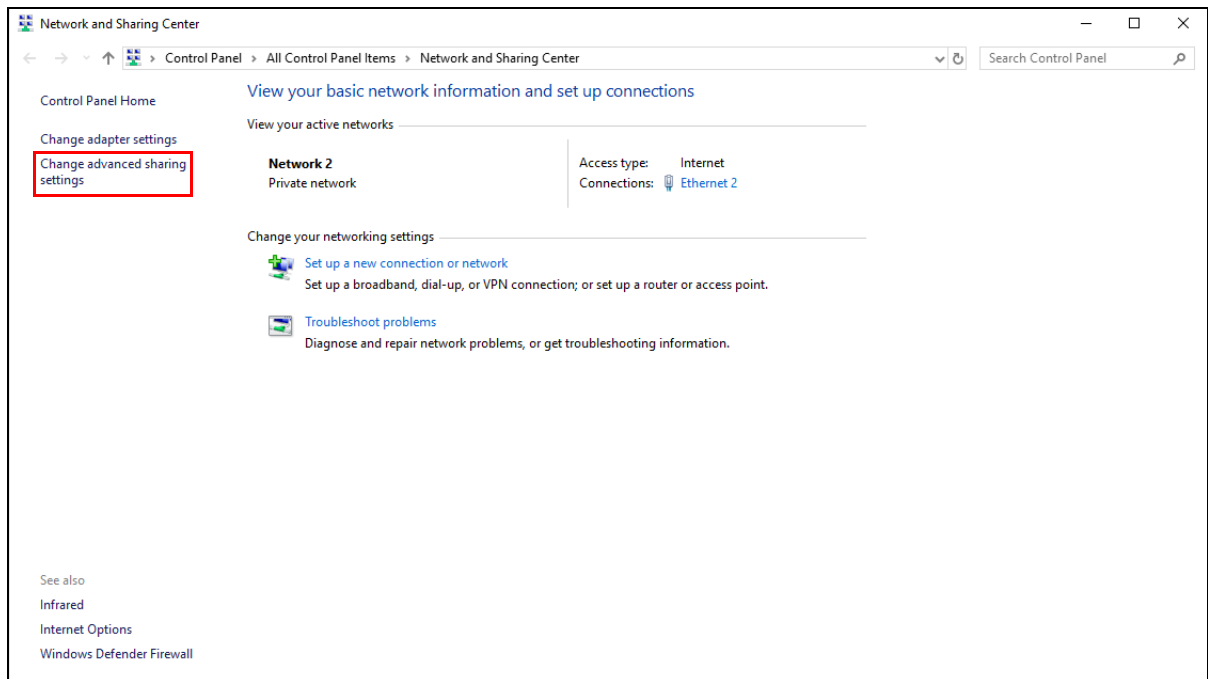

4 Under **Domain**, select **Turn on network discovery** and click **Save Changes**. Network discovery allows your computer to find other computers and devices on the network and other computers on the network to find your computer. This makes it easier to share files and printers.

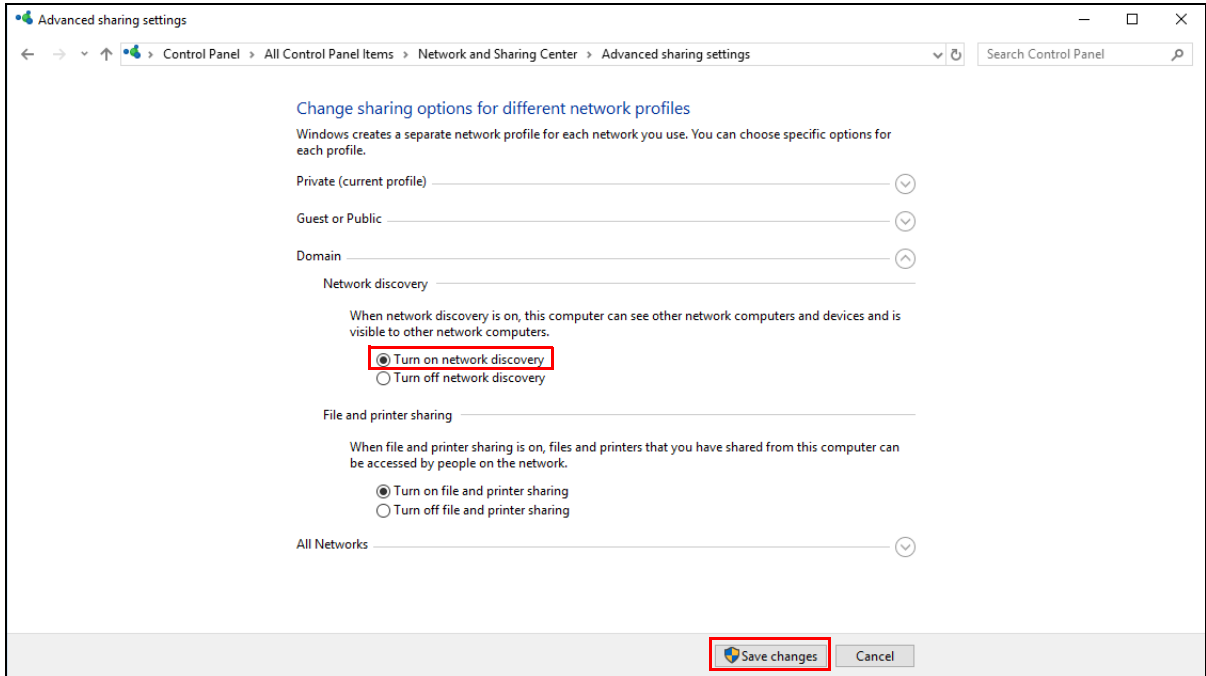

10.9.1 Auto-discover Your UPnP-enabled Network Device

Before you follow these steps, make sure you already have UPnP activated on the Zyxel Device and in your computer.

Make sure your computer is connected to the LAN port of the Zyxel Device.

- 1 Open **File Explorer** and click **Network**.
- 2 Right-click the Zyxel Device icon and select **Properties**.

Figure 91 Network Connections

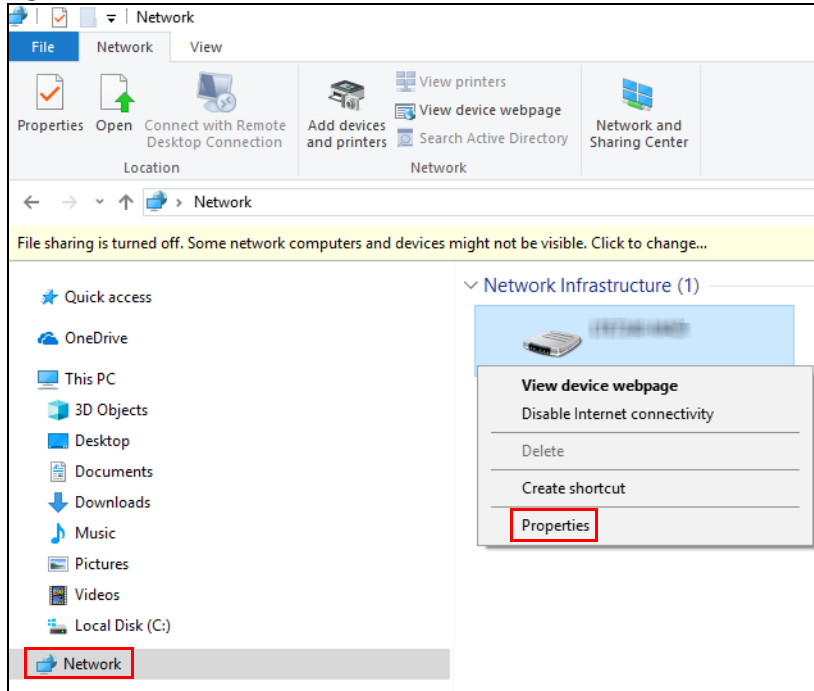

- 3 In the **Internet Connection Properties** window, click **Settings** to see port mappings.

Figure 92 Internet Connection Properties

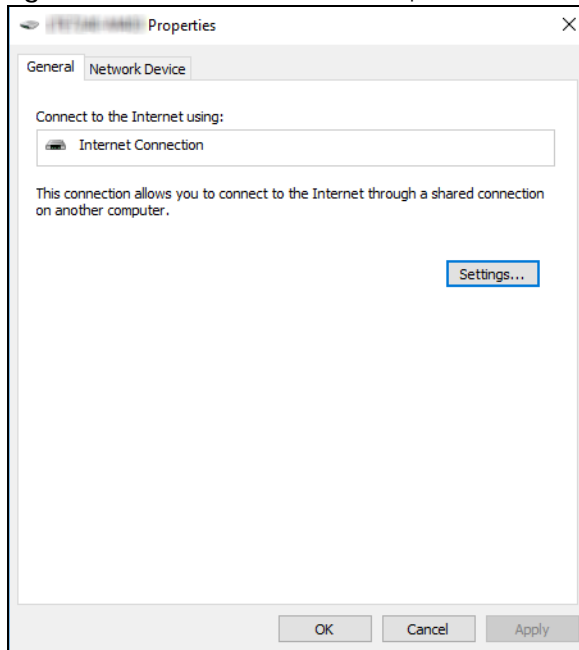

- 4 You may edit or delete the port mappings or click **Add** to manually add port mappings.

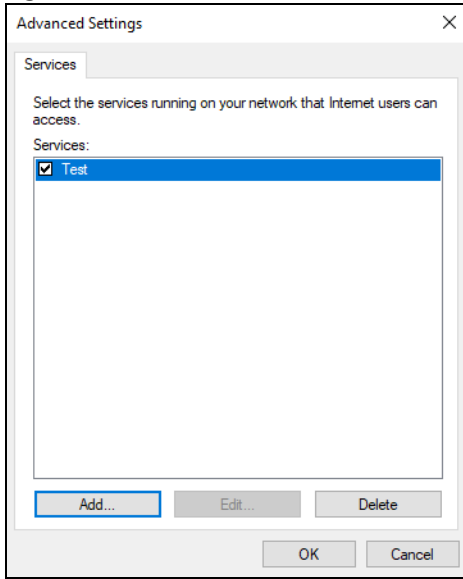
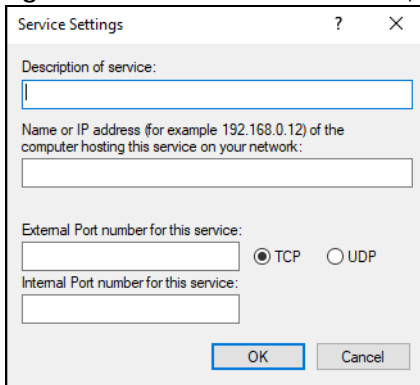
Figure 93 Internet Connection Properties: Advanced Settings**Figure 94** Internet Connection Properties: Advanced Settings: Add

Note: When the UPnP-enabled device is disconnected from your computer, all port mappings will be deleted automatically.

- 5 Click **OK**. Check the network icon on the system tray to see your Internet connection status.

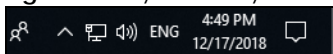
Figure 95 System Tray Icon

- 6 To see more details about your current Internet connection status, right click the network icon in the system tray and click **Open Network & Internet settings**. Click **Network and Sharing Center** and click the **Connections**.

Figure 96 Internet Connection Status

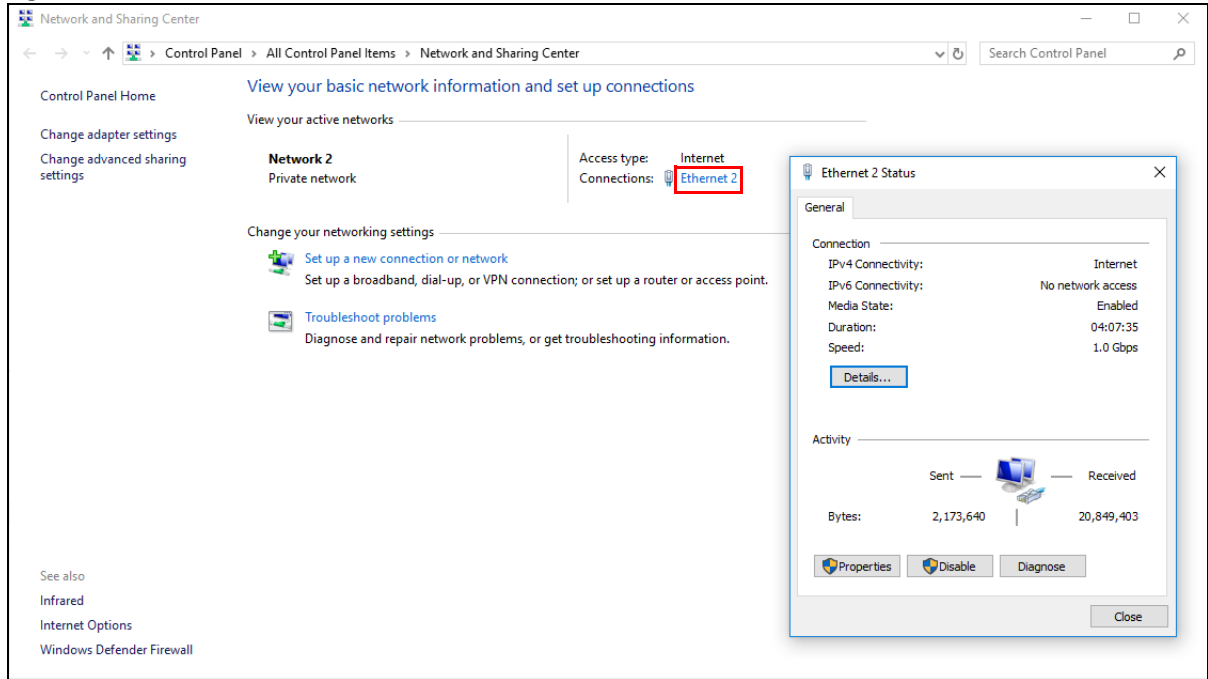

10.10 Web Configurator Easy Access in Windows 10

Follow the steps below to access the Web Configurator.

- 1 Open **File Explorer**.
- 2 Click **Network**.

Figure 97 Network Connections

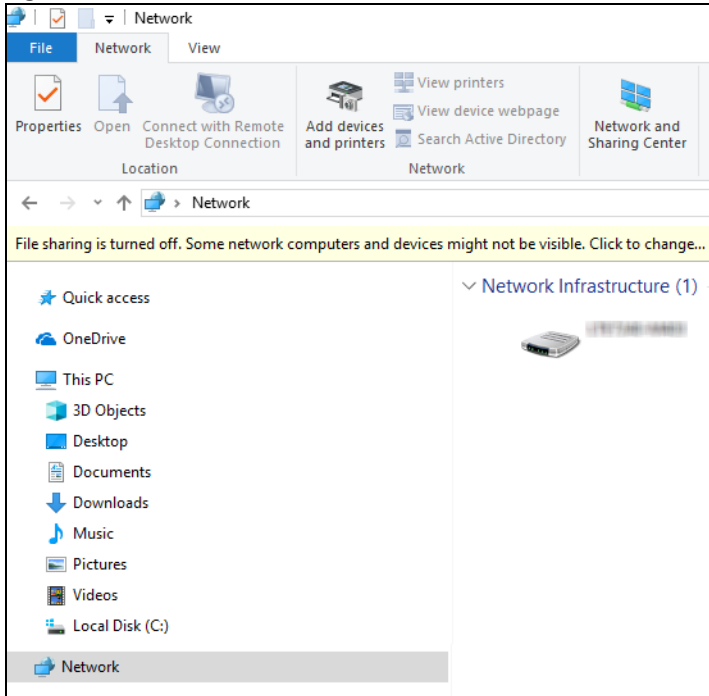

- 3 An icon with the description for each UPnP-enabled device displays under **Network Infrastructure**.
- 4 Right-click the icon for your Zyxel Device and select **View device webpage**. The Web Configurator login screen displays.

Figure 98 Network Connections: Network Infrastructure

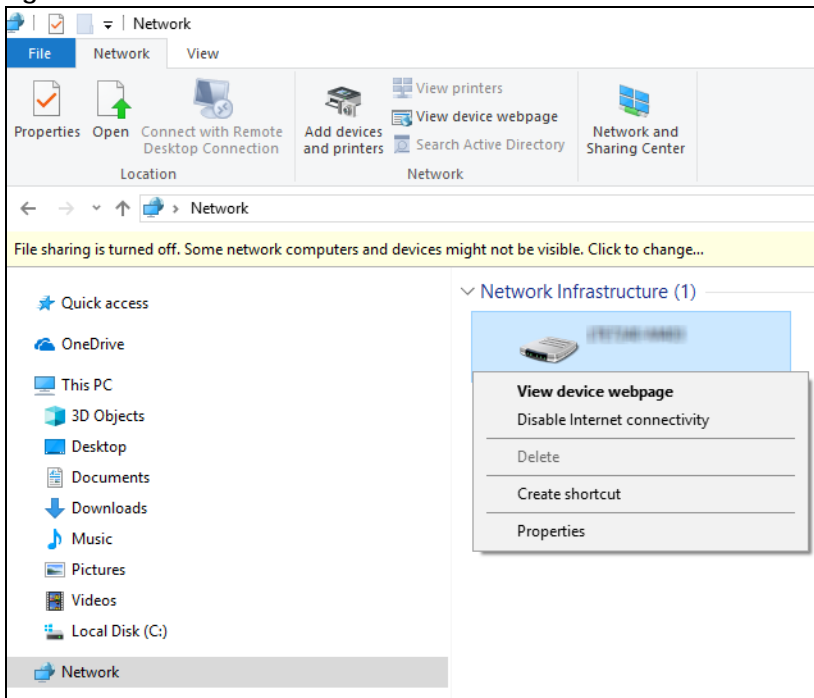

- 5 Right-click the icon for your Zyxel Device and select **Properties**. Click the **Network Device** tab. A window displays information about the Zyxel Device.

Figure 99 Network Connections: Network Infrastructure: Properties: Example

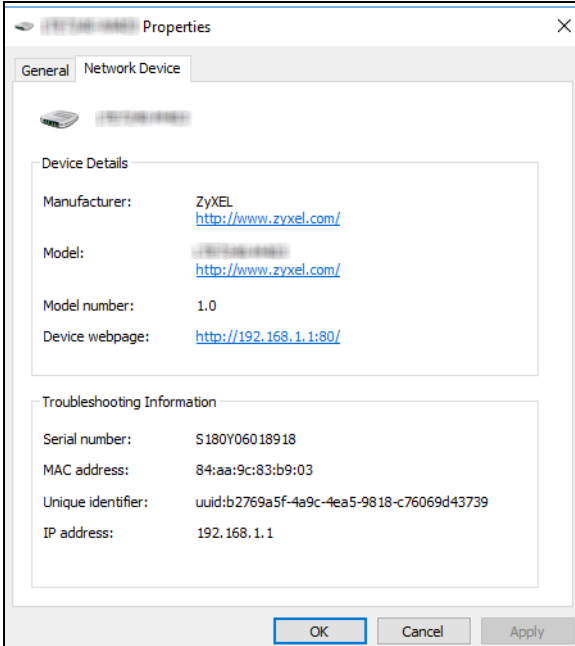

CHAPTER 11

Routing

11.1 Routing Overview

The Zyxel Device usually uses the default gateway to route outbound traffic from computers on the LAN to the Internet. To have the Zyxel Device send data to devices not reachable through the default gateway, use static routes.

For example, the next figure shows a computer (**A**) connected to the Zyxel Device's LAN interface. The Zyxel Device routes most traffic from **A** to the Internet through the Zyxel Device's default gateway (**R1**). You create one static route to connect to services offered by your ISP behind router **R2**. You create another static route to communicate with a separate network behind a router **R3** connected to the LAN.

Figure 100 Example of Static Routing Topology

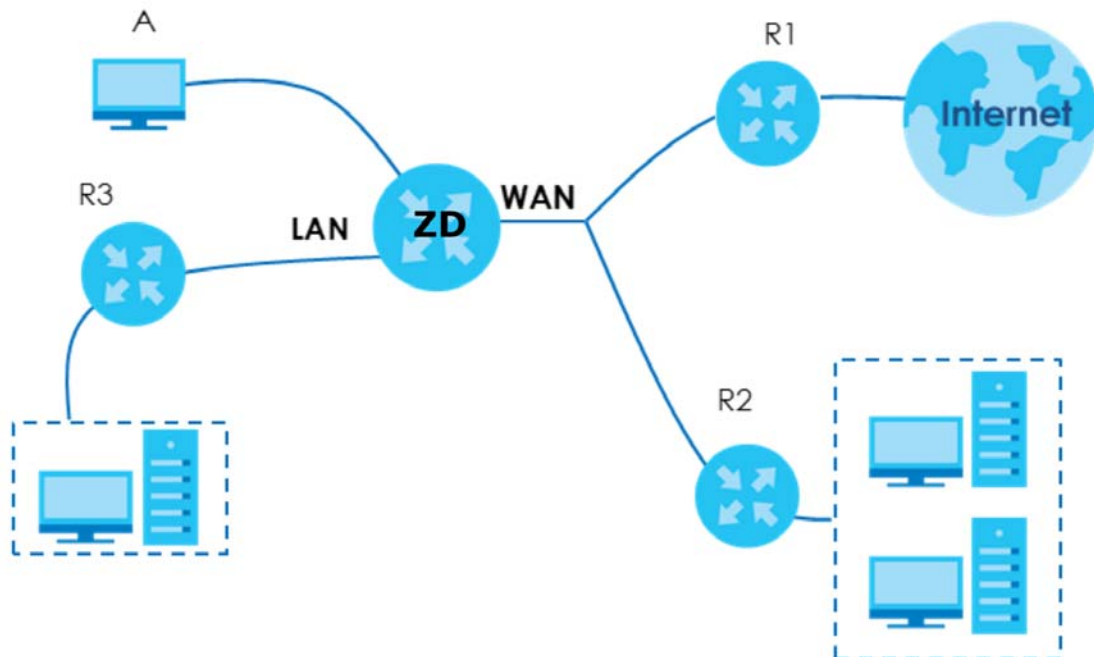

11.2 Configure Static Route

Use this screen to view and configure static route rules on the Zyxel Device. A static route is used to save time and bandwidth usage when LAN devices within an Intranet are transferring files or packets, especially when there are more than two Internet connections in your home or office network. Click **Network Setting > Routing** to open the **Static Route** screen.

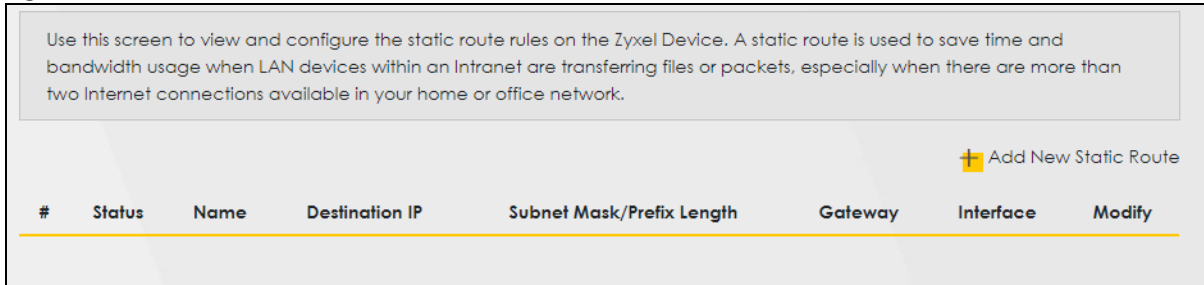
Figure 101 Network Setting > Routing > Static Route

The following table describes the labels in this screen.

Table 54 Network Setting > Routing > Static Route

LABEL	DESCRIPTION
Add New Static Route	Click this to set up a new static route on the Zyxel Device.
#	This is the number of an individual static route.
Status	This field indicates whether the rule is active (yellow bulb) or not (gray bulb).
Name	This is the name of the static route.
Destination IP	This parameter specifies the IP network address of the final destination. Routing is always based on network number.
Subnet Mask/Prefix Length	This parameter specifies the IP network subnet mask of the final destination.
Gateway	This is the IP address of the gateway. The gateway is a router or switch on the same network segment as the device's LAN or WAN port. The gateway helps forward packets to their destinations.
Interface	This is the WAN interface through which the traffic is routed.
Modify	Click the Edit icon to go to the screen where you can set up a static route on the Zyxel Device. Click the Delete icon to remove a static route from the Zyxel Device.

11.2.1 Add or Edit Static Route

Use this screen to add or edit a static route. Click **Add New Static Route** in the **Static Route** screen, the following screen appears. Configure the required information for a static route.

Note: The **Gateway IP Address** must be within the range of the selected interface in **Use Interface**.

Figure 102 Network Setting > Routing > Static Route > Add New Static Route

The following table describes the labels in this screen.

Table 55 Network Setting > Routing > Static Route > Add New Static Route

LABEL	DESCRIPTION
Active	Slide the switch button to the right to activate static route. Otherwise, click to disable.
Route Name	Assign a name for your static route (up to 15 characters). Special characters are allowed except the following: double quote (") back quote (`) apostrophe or single quote (') less than (<) greater than (>) caret or circumflex accent (^) dollar sign (\$) vertical bar () ampersand (&) semicolon (;)
IP Type	Select between IPv4 or IPv6 . Compared to IPv4 , IPv6 (Internet Protocol version 6), is designed to enhance IP address size and features. The increase in IPv6 address size to 128 bits (from the 32-bit IPv4 address) allows up to 3.4 x 10 ³⁸ IP addresses. The Zyxel Device can use IPv4/IPv6 dual stack to connect to IPv4 and IPv6 networks, and supports IPv6 rapid deployment (6RD).
Destination IP Address	This parameter specifies the IP network address of the final destination. Routing is always based on network number. If you need to specify a route to a single host, use a subnet mask of 255.255.255.255 in the subnet mask field to force the network number to be identical to the host ID.
Subnet Mask	If you are using IPv4 and need to specify a route to a single host, use a subnet mask of 255.255.255.255 in the subnet mask field to force the network number to be identical to the host ID. Enter the IP subnet mask here.
Use Gateway IP Address	The gateway is a router or switch on the same network segment as the device's LAN or WAN port. The gateway helps forward packets to their destinations. Click this switch to enable or disable the gateway IP address. When the switch goes to the right, the function is enabled. Otherwise, it is not.
Gateway IP Address	Enter the IP address of the gateway.
User Interface	Select the WAN interface you want to use for this static route.
OK	Click this to save your changes.
Cancel	Click this to exit this screen without saving.

11.2.1.1 An Example of Adding a Static Route

In order to extend your Intranet and control traffic flowing directions, you may connect a router to the Zyxel Device's LAN. The router may be used to separate two department networks. This tutorial shows how to configure a static routing rule for two network routings.

In the following figure, router **R** is connected to the Zyxel Device's LAN. **R** connects to two networks, **N1** (192.168.1.x/24) and **N2** (192.168.10.x/24). If you want to send traffic from computer **A** (in **N1** network) to computer **B** (in **N2** network), the traffic is sent to the Zyxel Device's WAN default gateway by default. In this case, **B** will never receive the traffic.

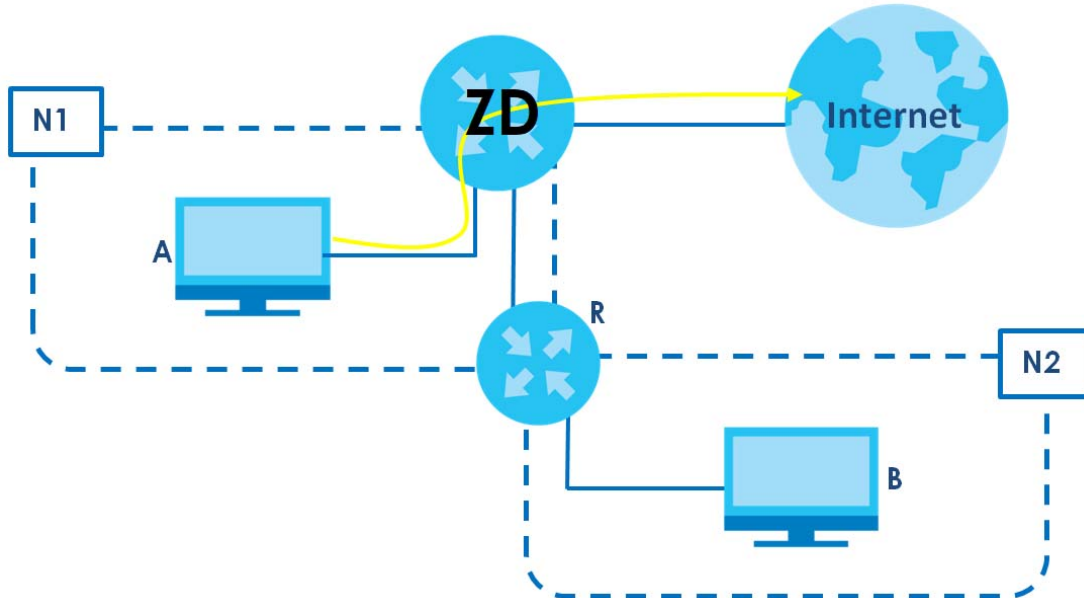

You need to specify a static routing rule on the Zyxel Device to specify **R** as the router in charge of forwarding traffic to **N2**. In this case, the Zyxel Device routes traffic from **A** to **R** and then **R** routes the traffic to **B**.

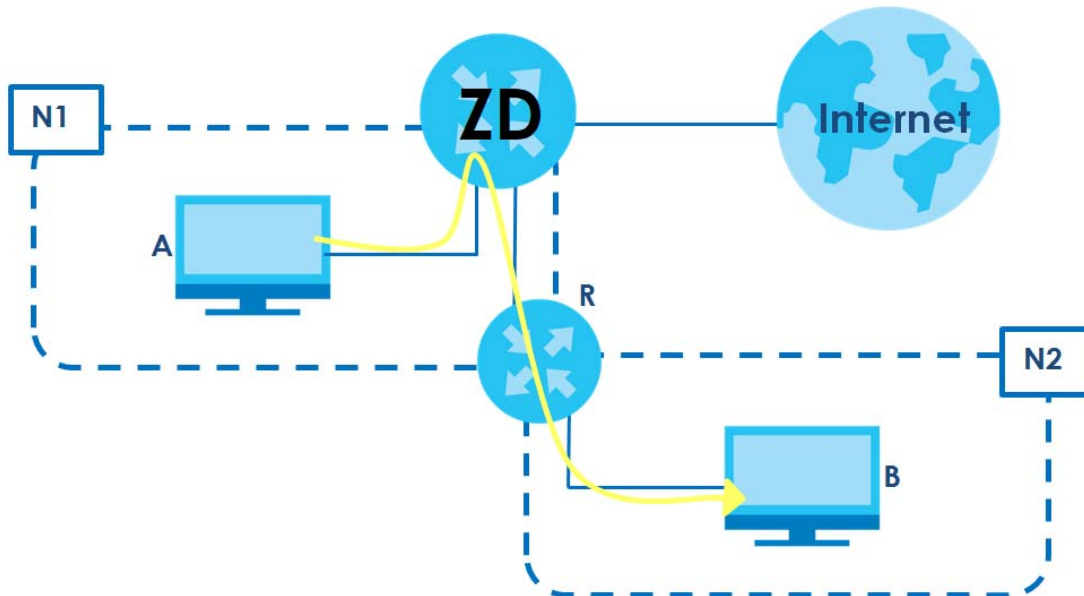

This tutorial uses the following example IP settings:

Table 56 IP Settings in this Tutorial

DEVICE / COMPUTER	IP ADDRESS
The Zyxel Device's WAN	172.16.1.1
The Zyxel Device's LAN	192.168.123.1
IP Type	IPv4
Use Interface	VDSL
A	192.168.1.34
R's N1	192.168.1.253
R's N2	192.168.10.2
B	192.168.10.33

To configure a static route to route traffic from **N1** to **N2**:

- 1 Log into the Zyxel Device's Web Configurator in advanced mode.
- 2 Click **Network Setting > Routing**.
- 3 Click **Add new Static Route** in the **Static Route** screen.

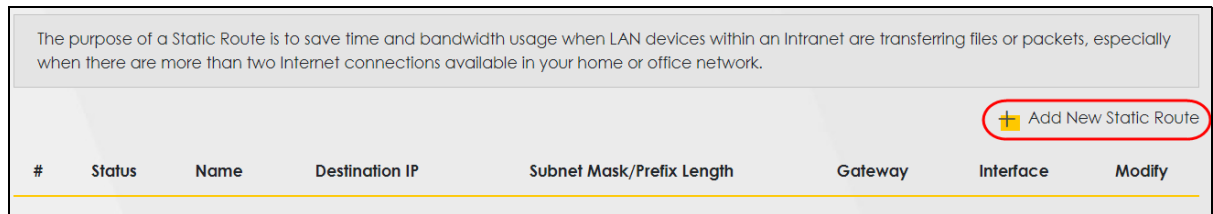

- 4 Configure the **Static Route Setup** screen using the following settings:
 - 4a Click the **Active** button to enable this static route. When the switch goes to the right () , the function is enabled. Enter the **Route Name** as **R**.
 - 4b Set **IP Type** to **IPv4**.
 - 4c Type the **Destination IP Address** **192.168.10.0** and **IP Subnet Mask** **255.255.255.0** for the destination, **N2**.
 - 4d Click the **Use Gateway IP Address** button to enable this function. When the switch goes to the right () , the function is enabled. Type **192.168.1.253** (**R's N1** address) in the **Gateway IP Address** field.
 - 4e Select **VDSL** as the **Use Interface**.
 - 4f Click **OK**.

Now **B** should be able to receive traffic from **A**. You may need to additionally configure **B's** firewall settings to allow specific traffic to pass through.

Add New Static Route

Active

Route Name

IP Type

Destination IP Address

Subnet Mask

Use Gateway IP Address

Gateway IP Address

Use Interface

Note
The input range of the Gateway IP Address must be in the same range of the Use Interface.

Cancel

11.3 DNS Route

Use this screen to view and configure DNS routes on the Zyxel Device. A DNS route entry defines a policy for the Zyxel Device to forward a particular DNS query to a specific WAN interface. Click **Network Setting > Routing > DNS Route** to open the **DNS Route** screen.

Figure 103 Network Setting > Routing > DNS Route

Use this screen to view and configure DNS routes on the Zyxel Device. A DNS route entry defines a policy for the Zyxel Device to forward a particular DNS query to a specific WAN interface.

#	Status	Domain Name	WAN Interface	Subnet Mask	Modify

Note
Maximum of 20 entries can be added.

The following table describes the labels in this screen.

Table 57 Network Setting > Routing > DNS Route

LABEL	DESCRIPTION
Add New DNS Route	Click this to create a new entry.
#	This is the number of an individual DNS route.
Status	This field indicates whether the rule is active (yellow bulb) or not (gray bulb).
Domain Name	This is the domain name to which the DNS route applies.
WAN Interface	This is the WAN interface through which the matched DNS request is routed.

Table 57 Network Setting > Routing > DNS Route (continued)

LABEL	DESCRIPTION
Subnet Mask	This parameter specifies the IP network subnet mask.
Modify	Click the Edit icon to configure a DNS route on the Zyxel Device. Click the Delete icon to remove a DNS route from the Zyxel Device.

11.3.1 Add or Edit DNS Route

You can manually add the Zyxel Device's DNS route entry. Click **Add New DNS Route** in the **DNS Route** screen, use this screen to configure the required information for a DNS route.

Figure 104 Network Setting > Routing > DNS Route > Add New DNS Route

The following table describes the labels in this screen.

Table 58 Network Setting > Routing > DNS Route > Add New DNS Route

LABEL	DESCRIPTION
Active	Enable DNS route in your Zyxel Device.
Domain Name	Enter the domain name you want to resolve. You can use the wildcard character, an "*" (asterisk) as the left most part of a domain name, such as *.example.com. The Zyxel Device forwards DNS queries for any domain name ending in example.com to the WAN interface specified in this route.
Subnet Mask	Type the subnet mask of the network for which to use the DNS route in dotted decimal notation, for example 255.255.255.255.
WAN Interface	Select a WAN interface through which the matched DNS query is sent. You must have the WAN interfaces already configured in the Broadband screen.
OK	Click this to save your changes.
Cancel	Click this to exit this screen without saving.

11.4 Policy Route

By default, the Zyxel Device routes packets based on the shortest path to the destination address. Policy routes allow you to override the default behavior and route packets based on other criteria, such as the source address. For example, you can use policy-based routing to direct traffic from specific users through specific connections or distribute traffic across multiple paths for load sharing. Policy-based routing is applied to outgoing packets before the default routing rules are applied.

The **Policy Route** screen let you view and configure routing policies on the Zyxel Device. Click **Network Setting > Routing > Policy Route** to open the following screen.

Figure 105 Network Setting > Routing > Policy Route

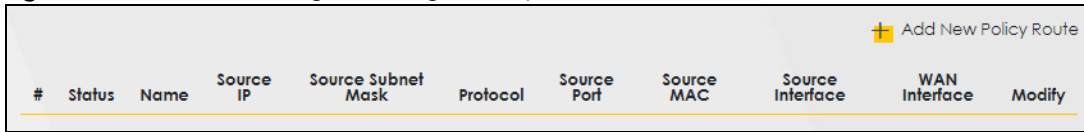

#	Status	Name	Source IP	Source Subnet Mask	Protocol	Source Port	Source MAC	Source Interface	WAN Interface	Modify
---	--------	------	-----------	--------------------	----------	-------------	------------	------------------	---------------	--------

The following table describes the labels in this screen.

Table 59 Network Setting > Routing > Policy Route

LABEL	DESCRIPTION
Add New Policy Route	Click this to create a new policy forwarding rule.
#	This is the index number of the entry.
Status	This field displays whether the DNS route is active or not. A yellow bulb signifies that this DNS route is active. A gray bulb signifies that this DNS route is not active.
Name	This is the name of the rule.
Source IP	This is the source IP address.
Source Subnet Mask	This is the source subnet mask address.
Protocol	This is the transport layer protocol.
Source Port	This is the source port number.
Source MAC	This is the source MAC address.
Source Interface	This is the interface from which the matched traffic is sent.
WAN Interface	This is the WAN interface through which the traffic is routed.
Modify	Click the Edit icon to edit this policy. Click the Delete icon to remove a policy from the Zyxel Device. A window displays asking you to confirm that you want to delete the policy.

11.4.1 Add or Edit Policy Route

Click **Add New Policy Route** in the **Policy Route** screen or click the **Edit** icon next to a policy. Use this screen to configure the required information for a policy route.

Figure 106 Network Setting > Routing > Policy Route: Add or Edit

The following table describes the labels in this screen.

Table 60 Network Setting > Routing > Policy Route: Add or Edit

LABEL	DESCRIPTION
Active	Click this to enable (turns blue) activation of the policy route. Otherwise, click to disable (turns gray).
Route Name	Enter a descriptive name of up to eight printable English keyboard characters, not including spaces.
Source IP Address	Enter the source IP address.
Source Subnet Mask	Enter the source subnet mask address.
Protocol	Select the transport layer protocol (TCP , UDP , or None).
Source Port	Enter the source port number.
Source MAC	Enter the source MAC address.
Source Interface (example: br0 or LAN1 – LAN4)	Type the name of the interface from which the matched traffic is sent.
WAN Interface	Select a WAN interface through which the traffic is sent. You must have the WAN interfaces already configured in the Broadband screens.
Cancel	Click Cancel to exit this screen without saving.
OK	Click OK to save your changes.

CHAPTER 12

Network Address Translation (NAT)

12.1 NAT Overview

NAT (Network Address Translation – NAT, RFC 1631) is the translation of the IP address of a host in a packet, for example, the source address of an outgoing packet, used within one network to a different IP address known within another network.

12.1.1 What You Can Do in this Chapter

- Use the **Port Forwarding** screen to configure forward incoming service requests to the servers on your local network ([Section 12.2 on page 177](#)).
- Use the **Port Triggering** screen to add and configure the Zyxel Device's trigger port settings ([Section 12.3 on page 180](#)).
- Use the **DMZ** screen to configure a default server ([Section 12.4 on page 183](#)).
- Use the **ALG** screen to enable or disable the SIP ALG ([Section 12.5 on page 184](#)).
- Use the **Address Mapping** screen to enable and disable the NAT Address Mapping in the Zyxel Device ([Section 12.6 on page 185](#)).
- Use the **Sessions** screen to limit the number of concurrent NAT sessions each client can use ([Section 12.7 on page 188](#)).

12.1.2 What You Need To Know

The following terms and concepts may help as you read this chapter.

Inside/Outside and Global/Local

Inside/outside denotes where a host is located relative to the Zyxel Device, for example, the computers of your subscribers are the inside hosts, while the web servers on the Internet are the outside hosts.

Global/local denotes the IP address of a host in a packet as the packet traverses a router, for example, the local address refers to the IP address of a host when the packet is in the local network, while the global address refers to the IP address of the host when the same packet is traveling in the WAN side.

NAT

In the simplest form, NAT changes the source IP address in a packet received from a subscriber (the inside local address) to another (the inside global address) before forwarding the packet to the WAN side. When the response comes back, NAT translates the destination address (the inside global address) back to the inside local address before forwarding it to the original inside host.

Port Forwarding

A port forwarding set is a list of inside (behind NAT on the LAN) servers, for example, web or FTP, that you can make visible to the outside world even though NAT makes your whole inside network appear as a single computer to the outside world.

12.2 Port Forwarding

Use **Port Forwarding** to forward incoming service requests from the Internet to the servers on your local network. Port forwarding is commonly used when you want to host online gaming, P2P file sharing, or other servers on your network.

You may enter a single port number or a range of port numbers to be forwarded, and the local IP address of the desired server. The port number identifies a service; for example, web service is on port 80 and FTP on port 21. In some cases, such as for unknown services or where one server can support more than one service (for example both FTP and web service), it might be better to specify a range of port numbers. You can allocate a server IP address that corresponds to a port or a range of ports. Please refer to RFC 1700 for further information about port numbers.

Note: Many residential broadband ISP accounts do not allow you to run any server processes (such as a Web or FTP server) from your location. Your ISP may periodically check for servers and may suspend your account if it discovers any active services at your location. If you are unsure, refer to your ISP.

Configure Servers Behind Port Forwarding (Example)

Let's say you want to assign ports 21-25 to one FTP, Telnet and SMTP server (**A** in the example), port 80 to another (**B** in the example), a default server IP address of 192.168.1.35 to a third (**C** in the example), and a default server IP address of 192.168.1.36 to a fourth (**D** in the example). You assign the LAN IP addresses and the ISP assigns the WAN IP address. The NAT network appears as a single host on the Internet.

Figure 107 Multiple Servers Behind NAT Example

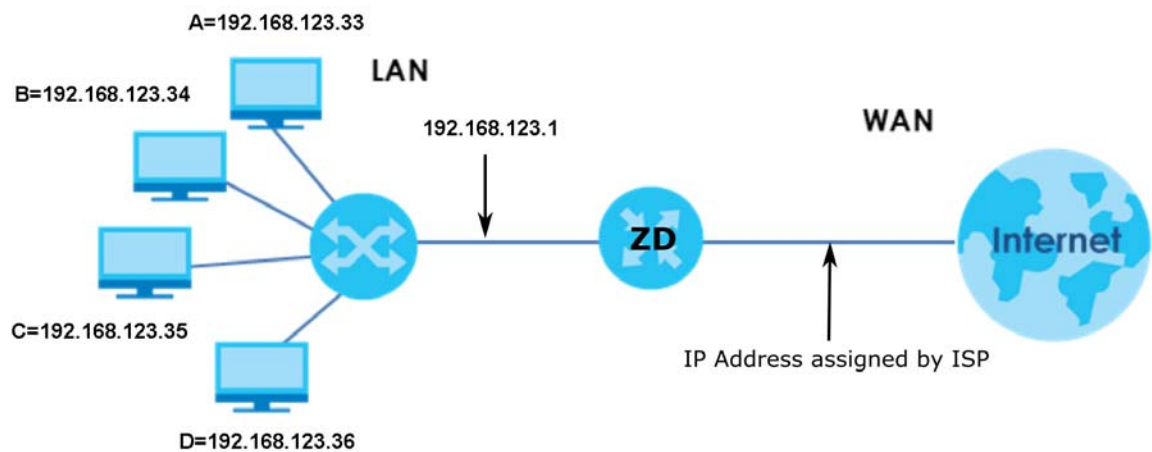

12.2.1 Port Forwarding

Click **Network Setting** > **NAT** to open the **Port Forwarding** screen.

Note: TCP port 7547 is reserved for system use.

Figure 108 Network Setting > NAT > Port Forwarding

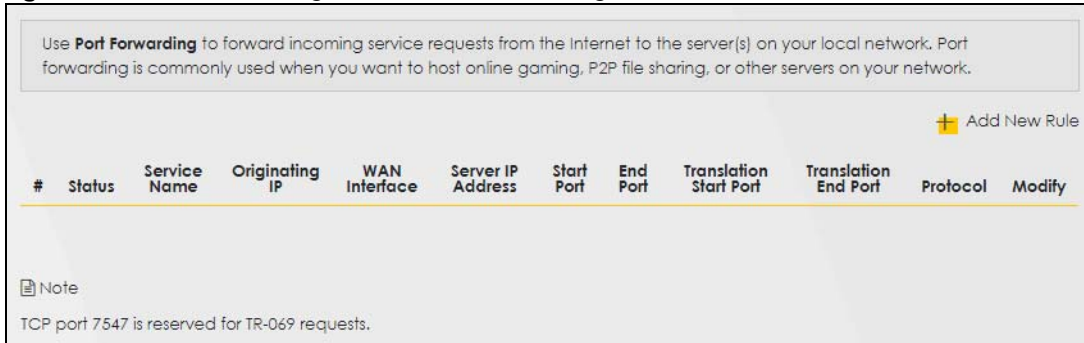

The following table describes the fields in this screen.

Table 61 Network Setting > NAT > Port Forwarding

LABEL	DESCRIPTION
Add New Rule	Click this to add a new port forwarding rule.
#	This is the index number of the entry.
Status	This field indicates whether the rule is active or not. A yellow bulb signifies that this rule is active. A gray bulb signifies that this rule is not active.
Service Name	This is the service's name. This shows User Defined if you manually added a service. You can change this by clicking the edit icon.
Originating IP	This is the source's IP address.
WAN Interface	Select the WAN interface for which to configure NAT port forwarding rules.
Server IP Address	This is the server's IP address.
Start Port	This is the first external port number that identifies a service.
End Port	This is the last external port number that identifies a service.
Translation Start Port	This is the first internal port number that identifies a service.
Translation End Port	This is the last internal port number that identifies a service.
Protocol	This field displays the protocol (TCP, UDP, TCP+UDP) used to transport the packets for which you want to apply the rule.
Modify	Click the Edit icon to edit the port forwarding rule. Click the Delete icon to delete an existing port forwarding rule. Note that subsequent address mapping rules move up by one when you take this action.

12.2.2 Add or Edit Port Forwarding

Create or edit a port forwarding rule. Specify either a port or a range of ports, a server IP address, and a protocol to configure a port forwarding rule. Click **Add New Rule** in the **Port Forwarding** screen or the **Edit** icon next to an existing rule to open the following screen.

Figure 109 Network Setting > NAT > Port Forwarding: Add or Edit

Add New Rule

Active

Service Name

WAN Interface

Start Port

End Port

Translation Start Port

Translation End Port

Server IP Address

Configure Originating IP Enable

Originating IP

Protocol

Note

(1) Create or edit a port forwarding rule. Specify either a port or a range of ports, a server IP address, and a protocol to configure a port forwarding rule.

(2) To configure port forwarding, you need to have the same configurations in the **Start Port**, **End Port**, **Translation Start Port**, and **Translation End Port** fields.
To configure port translation, you need to have different configurations in the **Start Port**, **End Port**, **Translation Start Port**, and **Translation End Port** fields.

(3) TCP port 7547 is reserved for system use.

Cancel OK

Note: To configure port forwarding, you need to have the same configurations in the **Start Port**, **End Port**, **Translation Start Port**, and **Translation End Port** fields.
To configure port translation, you need to have different configurations in the **Start Port**, **End Port**, **Translation Start Port**, and **Translation End Port** fields.
Here is an example to configure port translation. Configure **Start Port** to 100, **End Port** to 120, **Translation Start Port** to 200, and **Translation End Port** to 220.

Note: TCP port 7547 is reserved for system use.

The following table describes the labels in this screen.

Table 62 Network Setting > NAT > Port Forwarding: Add or Edit

LABEL	DESCRIPTION
Active	Click to turn the port forwarding rule on or off.
Service Name	Select a service to forward or select User Defined and enter a name in the field to the right.
WAN Interface	Select the WAN interface for which to configure NAT port forwarding rules.

Table 62 Network Setting > NAT > Port Forwarding: Add or Edit (continued)

LABEL	DESCRIPTION
Start Port	Configure this for a user-defined entry. Enter the original destination port for the packets. To forward only one port, enter the port number again in the End Port field. To forward a series of ports, enter the start port number here and the end port number in the End Port field.
End Port	Configure this for a user-defined entry. Enter the last port of the original destination port range. To forward only one port, enter the port number in the Start Port field above and then enter it again in this field. To forward a series of ports, enter the last port number in a series that begins with the port number in the Start Port field above.
Translation Start Port	Configure this for a user-defined entry. This shows the port number to which you want the Zyxel Device to translate the incoming port. For a range of ports, enter the first number of the range to which you want the incoming ports translated.
Translation End Port	Configure this for a user-defined entry. This shows the last port of the translated port range.
Server IP Address	Enter the inside IP address of the virtual server here.
Configure Originating IP	Click the Enable check box to enter the source IP in the next field.
Originating IP	Enter the source IP address here.
Protocol	Select the protocol supported by this virtual server. Choices are TCP , UDP , or TCP/UDP .
OK	Click this to save your changes.
Cancel	Click this to exit this screen without saving.

12.3 Port Triggering

Some services use a dedicated range of ports on the client side and a dedicated range of ports on the server side. With regular port forwarding, you set a forwarding port in NAT to forward a service (coming in from the server on the WAN) to the IP address of a computer on the client side (LAN). The problem is that port forwarding only forwards a service to a single LAN IP address. In order to use the same service on a different LAN computer, you have to manually replace the LAN computer's IP address in the forwarding port with another LAN computer's IP address.

Trigger port forwarding allows computers on the LAN to dynamically take turns using the service.

The Zyxel Device records the IP address of a LAN computer that sends traffic to the WAN to request a service with a specific port number and protocol (a \"trigger\" port). When the Zyxel Device's WAN port receives a response with a specific port number and protocol (\"open\" port), the Zyxel Device forwards the traffic to the LAN IP address of the computer that sent the request. After that computer's connection for that service closes, another computer on the LAN can use the service in the same manner. This way you do not need to configure a new IP address each time you want a different LAN computer to use the application.

For example:

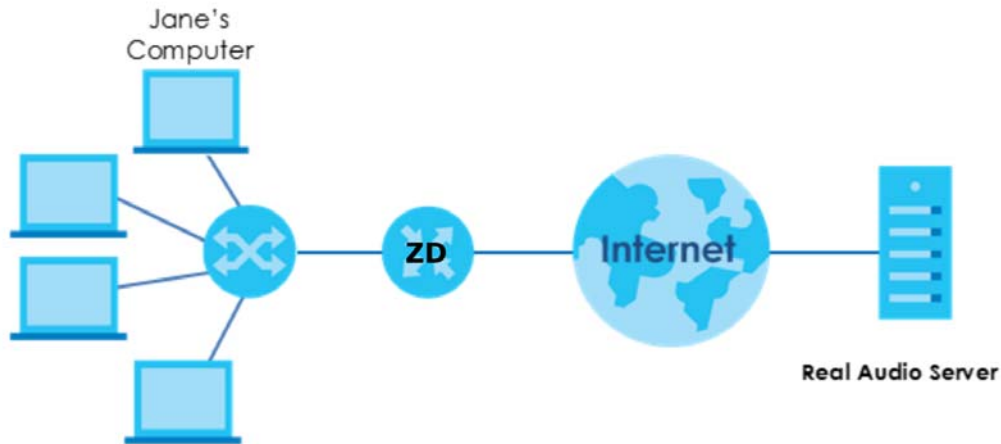
Figure 110 Trigger Port Forwarding Process: Example

- 1 Jane requests a file from the Real Audio server (port 7070).
- 2 Port 7070 is a "trigger" port and causes the Zyxel Device to record Jane's computer IP address. The Zyxel Device associates Jane's computer IP address with the "open" port range of 6970 – 7170.
- 3 The Real Audio server responds using a port number ranging between 6970 – 7170.
- 4 The Zyxel Device forwards the traffic to Jane's computer IP address.
- 5 Only Jane can connect to the Real Audio server until the connection is closed or times out. The Zyxel Device times out in 3 minutes with UDP (User Datagram Protocol) or 2 hours with TCP/IP (Transfer Control Protocol/Internet Protocol).

Click **Network Setting > NAT > Port Triggering** to open the following screen. Use this screen to view your Zyxel Device's trigger port settings.

Note: TCP port 7547 is reserved for system use.

Note: The sum of trigger ports in all rules must be less than 1000 and every open port range must be less than 1000. When the protocol is TCP/UDP, the ports are counted twice.

Figure 111 Network Setting > NAT > Port Triggering

#	Status	Service Name	WAN Interface	Trigger Start Port	Trigger End Port	Trigger Proto.	Open Start Port	Open End Port	Open Protocol	Modify
+ Add New Rule										

The following table describes the labels in this screen.

Table 63 Network Setting > NAT > Port Triggering

LABEL	DESCRIPTION
Add New Rule	Click this to create a new rule.
#	This is the index number of the entry.
Status	This field displays whether the port triggering rule is active or not. A yellow bulb signifies that this rule is active. A gray bulb signifies that this rule is not active.

Table 63 Network Setting > NAT > Port Triggering (continued)

LABEL	DESCRIPTION
Service Name	This field displays the name of the service used by this rule.
WAN Interface	This field shows the WAN interface through which the service is forwarded.
Trigger Start Port	The trigger port is a port (or a range of ports) that causes (or triggers) the Zyxel Device to record the IP address of the LAN computer that sent the traffic to a server on the WAN. This is the first port number that identifies a service.
Trigger End Port	This is the last port number that identifies a service.
Trigger Proto.	This is the trigger transport layer protocol.
Open Start Port	The open port is a port (or a range of ports) that a server on the WAN uses when it sends out a particular service. The Zyxel Device forwards the traffic with this port (or range of ports) to the client computer on the LAN that requested the service. This is the first port number that identifies a service.
Open End Port	This is the last port number that identifies a service.
Open Protocol	This is the open transport layer protocol.
Modify	Click the Edit icon to edit this rule. Click the Delete icon to delete an existing rule.

12.3.1 Add or Edit Port Triggering Rule

This screen lets you create new port triggering rules. Click **Add New Rule** in the **Port Triggering** screen or click a rule's **Edit** icon to open the following screen. Use this screen to configure a port or range of ports and protocols for sending out requests and for receiving responses.

Figure 112 Network Setting > NAT > Port Triggering: Add or Edit

The screenshot shows the 'Add New Rule' configuration screen. It features a back arrow in the top left corner. The title 'Add New Rule' is centered at the top. Below the title, there is a list of configuration options:

- Active:** A toggle switch that is currently turned on (blue).
- Service Name:** A text input field.
- WAN Interface:** A dropdown menu with 'Default' selected.
- Trigger Start Port:** A text input field.
- Trigger End Port:** A text input field.
- Trigger Protocol:** A dropdown menu with 'TCP' selected.
- Open Start Port:** A text input field.
- Open End Port:** A text input field.
- Open Protocol:** A dropdown menu with 'TCP' selected.

At the bottom of the screen, there are two buttons: 'Cancel' and 'OK'.

The following table describes the labels in this screen.

Table 64 Network Setting > NAT > Port Triggering: Add or Edit

LABEL	DESCRIPTION
Active	Click to enable (blue switch) or disable (gray switch) to activate or deactivate the rule.
Service Name	Enter a name to identify this rule using keyboard characters (A – Z, a – z, 1 – 2 and so on).
WAN Interface	Select a WAN interface for which you want to configure port triggering rules.
Trigger Start Port	The trigger port is a port (or a range of ports) that causes (or triggers) the Zyxel Device to record the IP address of the LAN computer that sent the traffic to a server on the WAN. Type a port number or the starting port number in a range of port numbers.
Trigger End Port	Type a port number or the ending port number in a range of port numbers.
Trigger Protocol	Select the transport layer protocol from TCP , UDP , or TCP/UDP .
Open Start Port	The open port is a port (or a range of ports) that a server on the WAN uses when it sends out a particular service. The Zyxel Device forwards the traffic with this port (or range of ports) to the client computer on the LAN that requested the service. Type a port number or the starting port number in a range of port numbers.
Open End Port	Type a port number or the ending port number in a range of port numbers.
Open Protocol	Select the transport layer protocol from TCP , UDP , or TCP/UDP .
Cancel	Click Cancel to exit this screen without saving.
OK	Click OK to save your changes.

12.4 DMZ

Use this screen to specify the IP address of a default server to receive packets from ports not specified in the **Port Triggering** screen. The DMZ (DeMilitarized Zone) is a network between the WAN and the LAN that is accessible to devices on both the WAN and LAN with firewall protection. Devices on the WAN can initiate connections to devices on the DMZ but not to those on the LAN.

You can put public servers, such as email, web, and FTP servers, on the DMZ to provide services on both the WAN and LAN. To use this feature, you first need to assign a DMZ host. Click **Network Setting > NAT > DMZ** to open the **DMZ** screen.

Note: Use an IPv4 address for the DMZ server.

Note: Enter the IP address of the default server in the **Default Server Address** field, and click **Apply** to activate the DMZ host. Otherwise, clear the IP address in the **Default Server Address** field, and click **Apply** to deactivate the DMZ host.

Figure 113 Network Setting > NAT > DMZ

Use this screen to specify the IP address of a default server to receive packets from ports not specified in the **Port Triggering** screen. The DMZ (DeMilitarized Zone) is a network between the WAN and the LAN that is accessible to devices on both the WAN and LAN with firewall protection. Devices on the WAN can initiate connections to devices on the DMZ but not to those on the LAN.

You can put public servers, such as email, web, and FTP servers, on the DMZ to provide services on both the WAN and LAN. To use this feature, you first need to assign a DMZ host.

Default Server Address

Note

Enter the IP address of the default server in the **Default Server Address** field, and click **Apply** to activate the DMZ host. Otherwise, clear the IP address in the **Default Server Address** field, and click **Apply** to deactivate the DMZ host.

The following table describes the fields in this screen.

Table 65 Network Setting > NAT > DMZ

LABEL	DESCRIPTION
Default Server Address	Enter the IP address of the default server which receives packets from ports that are not specified in the Port Forwarding screen. Note: If you do not assign a default server, the Zyxel Device discards all packets received for ports not specified in the virtual server configuration.
Apply	Click this to save your changes back to the Zyxel Device.
Cancel	Click Cancel to restore your previously saved settings.

12.5 ALG

Application Layer Gateway (ALG) allows customized NAT traversal filters to support address and port translation for certain applications such as File Transfer Protocol (FTP), Session Initiation Protocol (SIP), or file transfer in Instant Messaging (IM) applications. It allows SIP calls to pass through the Zyxel Device. When the Zyxel Device registers with the SIP register server, the SIP ALG translates the Zyxel Device's private IP address inside the SIP data stream to a public IP address. You do not need to use STUN or an outbound proxy if your Zyxel Device is behind a SIP ALG.

Click **Network Setting > NAT > ALG** to open the **ALG** screen. Use this screen to enable and disable the NAT Application Layer Gateway (ALG) in the Zyxel Device.

Application Layer Gateway (ALG) allows certain applications such as File Transfer Protocol (FTP), Session Initiation Protocol (SIP), or file transfer in Instant Messaging (IM) applications to pass through the Zyxel Device.

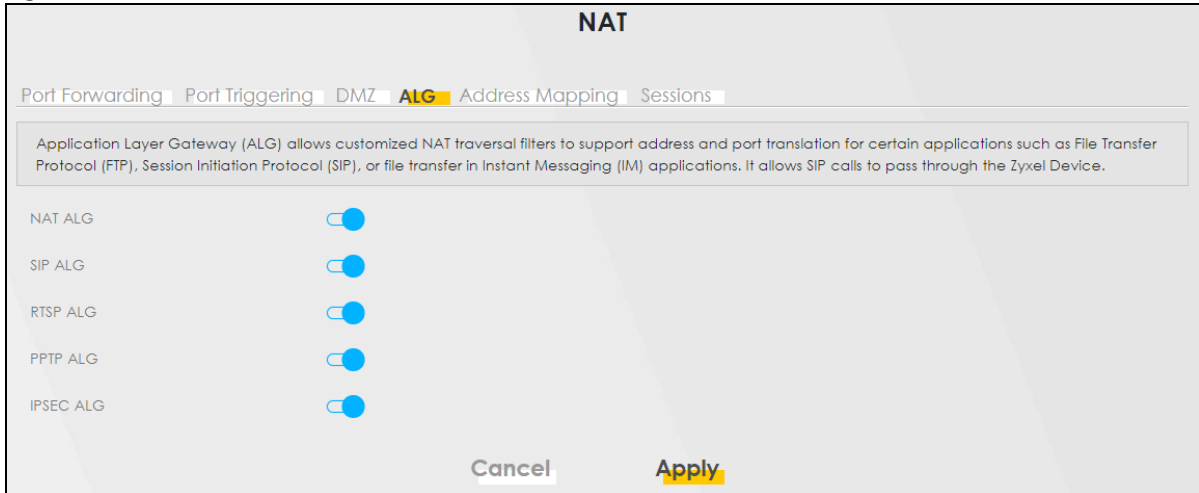
Figure 114 Network Setting > NAT > ALG

The following table describes the fields in this screen.

Table 66 Network Setting > NAT > ALG

LABEL	DESCRIPTION
NAT ALG	Enable this to make sure applications such as FTP and file transfer in IM applications work correctly with port-forwarding and address-mapping rules.
SIP ALG	Click this (switch turns blue) to make sure SIP (VoIP) works correctly with port-forwarding and address-mapping rules. Otherwise, click this to turn off (switch turns gray) the SIP ALG.
RTSP ALG	Enable this to have the Zyxel Device detect RTSP traffic and help build RTSP sessions through its NAT. The Real Time Streaming (media control) Protocol (RTSP) is a remote control for multimedia on the Internet.
PPTP ALG	Click this to turn on (switch turns blue) the PPTP ALG on the Zyxel Device to detect PPTP traffic and help build PPTP sessions through the Zyxel Device's NAT.
IPSEC ALG	Enable this to turn on the IPsec ALG on the Zyxel Device to detect IPsec traffic and help build IPsec sessions through the Zyxel Device's NAT.
Apply	Click Apply to save your changes back to the Zyxel Device.
Cancel	Click Cancel to restore your previously saved settings.

12.6 Address Mapping

Address mapping can map local IP Addresses to global IP addresses. Ordering your rules is important because the Zyxel Device applies the rules in the order that you specify. When a rule matches the current packet, the Zyxel Device takes the corresponding action and the remaining rules are ignored.

Use this screen to enable or disable the NAT Address Mapping in the Zyxel Device.

12.6.1 Address Mapping Screen

Click **Network Setting > NAT > Address Mapping** to open the **Address Mapping** screen.

Figure 115 Network Setting > NAT > Address Mapping

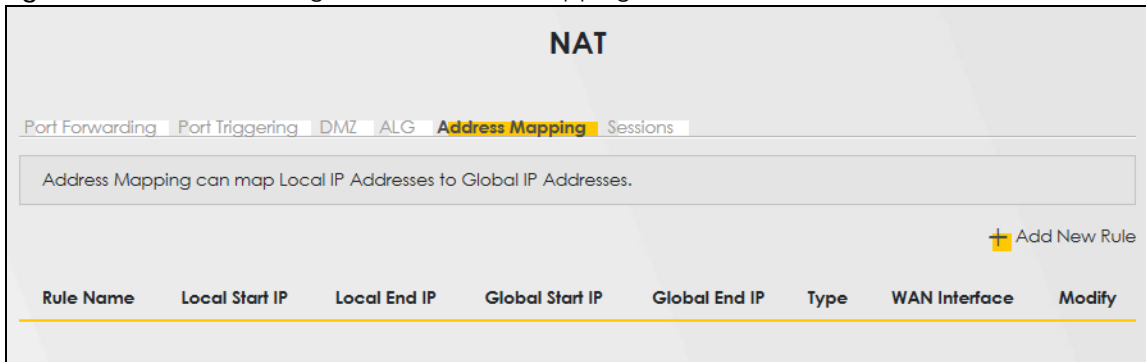

The following table describes the fields in this screen.

Table 67 Network Setting > NAT > Address Mapping

LABEL	DESCRIPTION
Add New Rule	Click this to create a new rule.
Rule Name	This is the name of the rule.
Local Start IP	This is the starting Inside Local IP Address (ILA).
Local End IP	This is the ending Inside Local IP Address (ILA). If the rule is for all local IP addresses, then this field displays 0.0.0.0 as the Local Start IP address and 255.255.255.255 as the Local End IP address. This field is blank for One-to-One mapping types.
Global Start IP	This is the starting Inside Global IP Address (IGA). Enter 0.0.0.0 here if you have a dynamic IP address from your ISP. You can only do this for the Many-to-One mapping type.
Global End IP	This is the ending Inside Global IP Address (IGA). This field is blank for One-to-One and Many-to-One mapping types.
Type	This is the address mapping type. One-to-One: This mode maps one local IP address to one global IP address. Note that port numbers do not change for the One-to-One NAT mapping type. Many-to-One: This mode maps multiple local IP addresses to one global IP address. This is equivalent to SUA (i.e., PAT, port address translation), the Device's Single User Account feature that previous routers supported only. Many-to-Many: This mode maps multiple local IP addresses to shared global IP addresses.
WAN Interface	This is the WAN interface to which the address mapping rule applies.
Modify	Click the Edit icon to go to the screen where you can edit the address mapping rule. Click the Delete icon to delete an existing address mapping rule. Note that subsequent address mapping rules move up by one when you take this action.

12.6.2 Add New Rule Screen

To add or edit an address mapping rule, click **Add New Rule** or the **Modify** icon in the **Address Mapping** screen to display the screen shown next.

Figure 116 Network Setting > NAT > Address Mapping > Add New Rule

The following table describes the fields in this screen.

Table 68 Network Setting > NAT > Address Mapping > Add New Rule

LABEL	DESCRIPTION
Rule Name	Type up to 20 alphanumeric characters for the name of this rule.
Type	Choose the IP or port mapping type from one of the following. One-to-One: This mode maps one local IP address to one global IP address. Note that port numbers do not change for the One-to-One NAT mapping type. Many-to-One: This mode maps multiple local IP addresses to one global IP address. This is equivalent to SUA (for example, PAT, port address translation), the device's Single User Account feature that previous routers supported only. Many-to-Many: This mode maps multiple local IP addresses to shared global IP addresses.
Local Start IP	Enter the starting Inside Local IP Address (ILA).
Local End IP	Enter the ending Inside Local IP Address (ILA). If the rule is for all local IP addresses, then this field displays 0.0.0.0 as the Local Start IP address and 255.255.255.255 as the Local End IP address. This field is blank for One-to-One mapping types.
Global Start IP	Enter the starting Inside Global IP Address (IGA). Enter 0.0.0.0 here if you have a dynamic IP address from your ISP. You can only do this for the Many-to-One mapping type.
Global End IP	Enter the ending Inside Global IP Address (IGA). This field is blank for One-to-One and Many-to-One mapping types.
WAN Interface	Select a WAN interface to which the address mapping rule applies.
Cancel	Click Cancel to exit this screen without saving.
OK	Click OK to save your changes.

12.7 Sessions

Use this screen to limit the number of concurrent NAT sessions a client can use, to ensure that no single client uses up too many available NAT sessions. Some applications, such as P2P file sharing, demand a greater number of NAT sessions in order to get a better uploading and downloading rate. Click **Network Setting > NAT > Sessions** to display the following screen.

Use the **Sessions** screen to limit the number of concurrent NAT sessions each client can use. Click **Network Setting > NAT > Sessions** to open the **Sessions** screen.

Note: Enter a number of concurrent NAT sessions in the **MAX NAT Session Per Host** field, and click **Apply** to limit the number of concurrent NAT sessions a client can use. Otherwise, clear the number in the **MAX NAT Session Per Host** field. Click **Apply** and there is no limit for concurrent NAT sessions a client can use.

Figure 117 Network Setting > NAT > Sessions

The following table describes the fields in this screen.

Table 69 Network Setting > NAT > Sessions

LABEL	DESCRIPTION
MAX NAT Session Per Host	Use this field to set a common limit to the number of concurrent NAT sessions each client computer can have. If only a few clients use peer to peer applications, you can raise this number to improve their performance. With heavy peer to peer application use, lower this number to ensure no single client uses too many of the available NAT sessions.
Cancel	Click Cancel to restore your previously saved settings.
Apply	Click Apply to save your changes.

12.8 Technical Reference

This part contains more information regarding NAT.

12.8.1 NAT Definitions

Inside or outside denotes where a host is located relative to the Zyxel Device, for example, the computers of your subscribers are the inside hosts, while the web servers on the Internet are the outside hosts.

Global or local denotes the IP address of a host in a packet as the packet traverses a router, for example, the local address refers to the IP address of a host when the packet is in the local network, while the global address refers to the IP address of the host when the same packet is traveling in the WAN side.

Note that inside or outside refers to the location of a host, while global/local refers to the IP address of a host used in a packet. Thus, an inside local address (ILA) is the IP address of an inside host in a packet when the packet is still in the local network, while an inside global address (IGA) is the IP address of the same inside host when the packet is on the WAN side. The following table summarizes this information.

Table 70 NAT Definitions

ITEM	DESCRIPTION
Inside	This refers to the host on the LAN.
Outside	This refers to the host on the WAN.
Local	This refers to the packet address (source or destination) as the packet travels on the LAN.
Global	This refers to the packet address (source or destination) as the packet travels on the WAN.

NAT never changes the IP address (either local or global) of an outside host.

12.8.2 What NAT Does

In the simplest form, NAT changes the source IP address in a packet received from a subscriber (the inside local address) to another (the inside global address) before forwarding the packet to the WAN side. When the response comes back, NAT translates the destination address (the inside global address) back to the inside local address before forwarding it to the original inside host. Note that the IP address (either local or global) of an outside host is never changed.

The global IP addresses for the inside hosts can be either static or dynamically assigned by the ISP. In addition, you can designate servers, for example, a web server and a telnet server, on your local network and make them accessible to the outside world. If you do not define any servers (for Many-to-One and Many-to-Many Overload mapping), NAT offers the additional benefit of firewall protection. With no servers defined, your Zyxel Device filters out all incoming inquiries, thus preventing intruders from probing your network. For more information on IP address translation, refer to *RFC 1631, The IP Network Address Translator (NAT)*.

12.8.3 How NAT Works

Each packet has two addresses – a source address and a destination address. For outgoing packets, the ILA (Inside Local Address) is the source address on the LAN, and the IGA (Inside Global Address) is the source address on the WAN. For incoming packets, the ILA is the destination address on the LAN, and the IGA is the destination address on the WAN. NAT maps private (local) IP addresses to globally unique ones required for communication with hosts on other networks. It replaces the original IP source address (and TCP or UDP source port numbers for Many-to-One and Many-to-Many Overload NAT mapping) in each packet and then forwards it to the Internet. The Zyxel Device keeps track of the original addresses and port numbers so incoming reply packets can have their original values restored. The following figure illustrates this.

Figure 118 How NAT Works

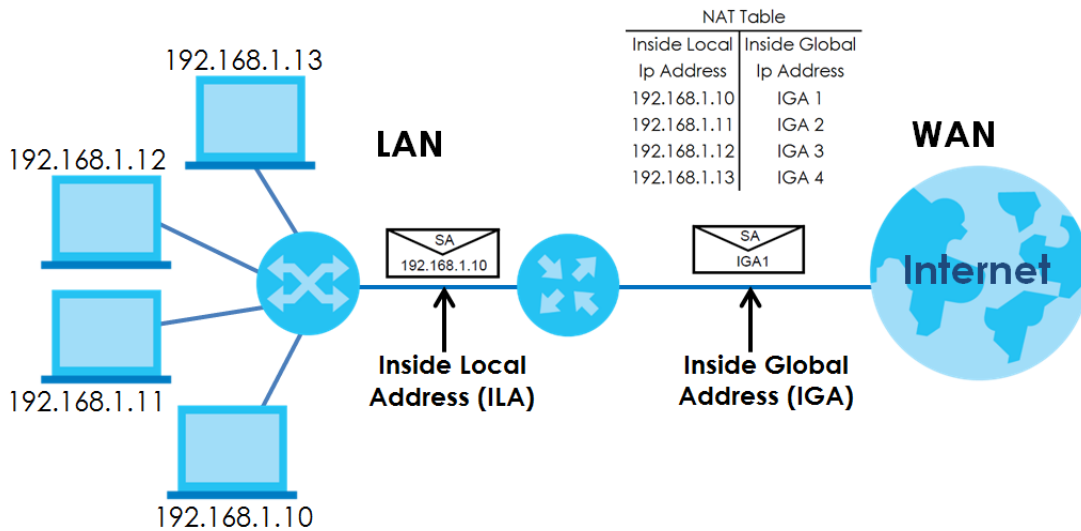

12.8.4 NAT Application

The following figure illustrates a possible NAT application, where three inside LANs (logical LANs using IP alias) behind the Zyxel Device can communicate with three distinct WAN networks.

Figure 119 NAT Application With IP Alias

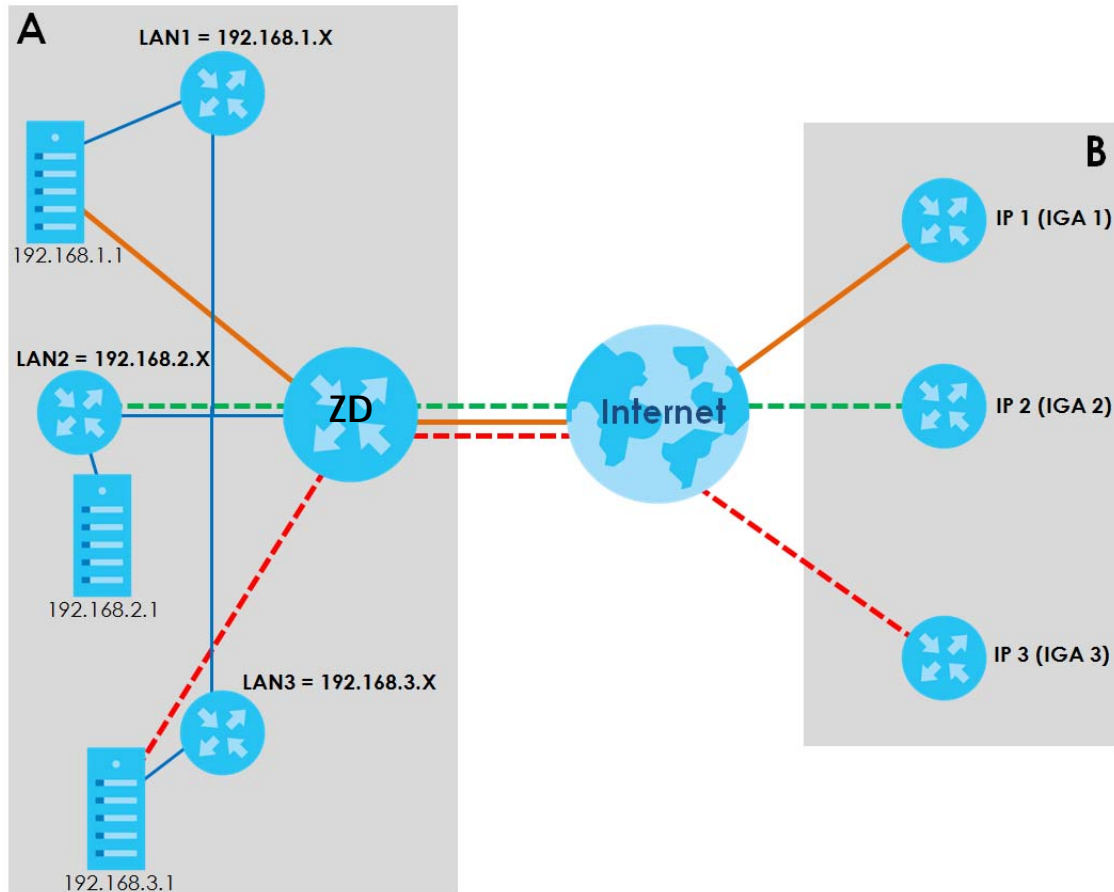

Port Forwarding: Services and Port Numbers

The most often used port numbers are shown in the following table. Please refer to RFC 1700 for further information about port numbers. Please also refer to the Supporting CD for more examples and details on port forwarding and NAT.

Table 71 Services and Port Numbers

SERVICES	PORT NUMBER
ECHO	7
FTP (File Transfer Protocol)	21
SMTP (Simple Mail Transfer Protocol)	25
DNS (Domain Name System)	53
Finger	79
HTTP (Hyper Text Transfer protocol or WWW, Web)	80
POP3 (Post Office Protocol)	110
NNTP (Network News Transport Protocol)	119
PPTP (Point-to-Point Tunneling Protocol)	1723

Port Forwarding Example

Let's say you want to assign ports 21 – 25 to one FTP, Telnet and SMTP server (**A** in the example), port 80 to another (**B** in the example) and assign a default server IP address of 192.168.1.35 to a third (**C** in the example). You assign the LAN IP addresses and the ISP assigns the WAN IP address. The NAT network appears as a single host on the Internet.

Figure 120 Multiple Servers Behind NAT Example

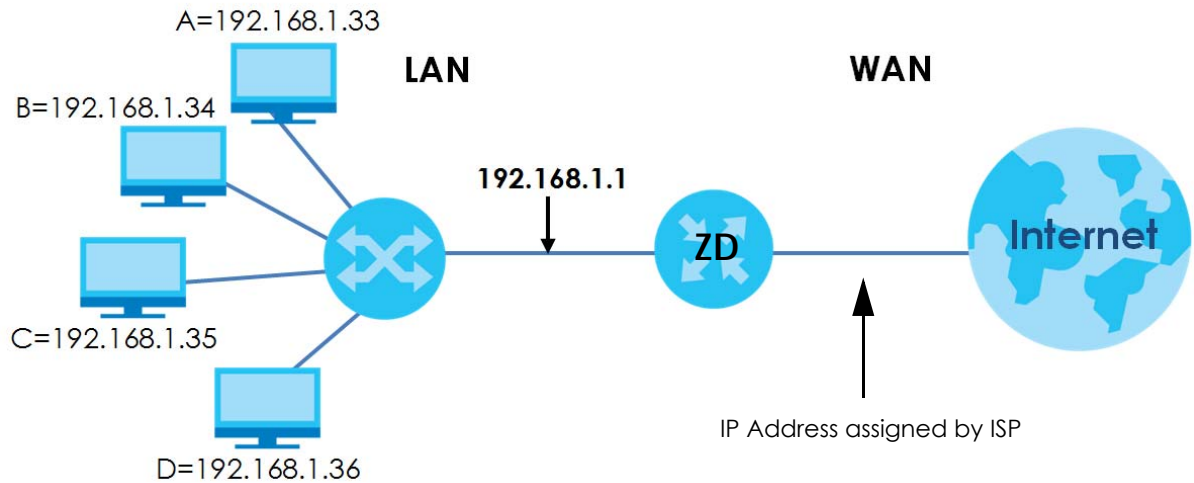

CHAPTER 13

DNS

13.1 DNS Overview

DNS

DNS (Domain Name System) is for mapping a domain name to its corresponding IP address and vice versa. The DNS server is extremely important because without it, you must know the IP address of a machine before you can access it.

In addition to the system DNS servers, each WAN interface (service) is set to have its own static or dynamic DNS server list. You can configure a DNS static route to forward DNS queries for certain domain names through a specific WAN interface to its DNS servers. The Zyxel Device uses a system DNS server (in the order you specify in the **Broadband** screen) to resolve domain names that do not match any DNS routing entry. After the Zyxel Device receives a DNS reply from a DNS server, it creates a new entry for the resolved IP address in the routing table.

Note: For information on configuring DNS route, see [Chapter 11 on page 167](#).

Dynamic DNS

Dynamic DNS allows you to use a dynamic IP address with one or many dynamic DNS services so that anyone can contact you (in NetMeeting, CU-SeeMe, etc.). You can also access your FTP server or Web site on your own computer using a domain name (for instance myhost.dhs.org, where myhost is a name of your choice) that will never change instead of using an IP address that changes each time you reconnect. Your friends or relatives will always be able to call you even if they do not know your IP address.

You first need to have registered a dynamic DNS account with www.dyndns.org. This is for people with a dynamic IP from their ISP or DHCP server that would still like to have a domain name. The Dynamic DNS service provider will give you a password or key.

13.1.1 What You Can Do in this Chapter

- Use the **DNS Entry** screen to view, configure, or remove DNS routes ([Section 13.2 on page 194](#)).
- Use the **Dynamic DNS** screen to enable DDNS and configure the DDNS settings on the Zyxel Device ([Section 13.3 on page 195](#)).

13.1.2 What You Need To Know

DYNDNS Wildcard

Enabling the wildcard feature for your host causes *.yourhost.dyndns.org to be aliased to the same IP address as yourhost.dyndns.org. This feature is useful if you want to be able to use, for example, www.yourhost.dyndns.org and still reach your hostname.

If you have a private WAN IP address, then you cannot use Dynamic DNS.

13.2 DNS Entry

DNS (Domain Name System) is used for mapping a domain name to its corresponding IP address and vice versa. Use this screen to view and configure manual DNS entries on the Zyxel Device. Click **Network Setting > DNS** to open the **DNS Entry** screen.

Note: The host name should consist of the host's local name and the domain name. For example, Mycomputer.home is a host name where Mycomputer is the host's local name, and .home is the domain name.

Figure 121 Network Setting > DNS > DNS Entry

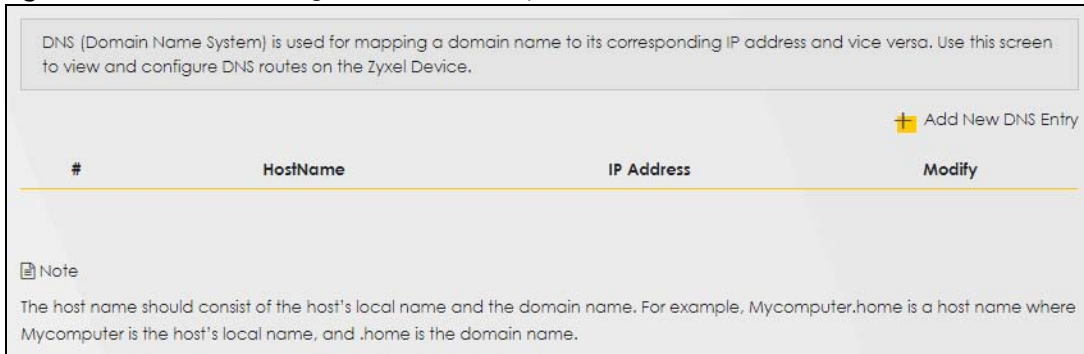

The following table describes the fields in this screen.

Table 72 Network Setting > DNS > DNS Entry

LABEL	DESCRIPTION
Add New DNS Entry	Click this to create a new DNS entry.
#	This is the index number of the entry.
HostName	This indicates the host name or domain name.
IP Address	This indicates the IP address assigned to this computer.
Modify	Click the Edit icon to edit the rule. Click the Delete icon to delete an existing rule.

13.2.1 Add or Edit DNS Entry

You can manually add or edit the Zyxel Device's DNS name and IP address entry. Click **Add New DNS Entry** in the **DNS Entry** screen or the **Edit** icon next to the entry you want to edit. The screen shown next appears.

Figure 122 Network Setting > DNS > DNS Entry: Add or Edit

The following table describes the labels in this screen.

Table 73 Network Setting > DNS > DNS Entry: Add or Edit

LABEL	DESCRIPTION
Host Name	Enter the host name of the DNS entry.
IPv4 Address	Enter the IPv4 address of the DNS entry.
Cancel	Click Cancel to exit this screen without saving.
OK	Click OK to save your changes.

13.3 Dynamic DNS

Dynamic DNS can update your current dynamic IP address mapping to a hostname. Configure a DDNS service provider on your Zyxel Device. Click **Network Setting > DNS > Dynamic DNS**. The screen appears as shown.

Figure 123 Network Setting > DNS > Dynamic DNS

Dynamic DNS can update your current dynamic IP address mapping to a hostname. Configure a DDNS service provider on your Zyxel Device.

Dynamic DNS Setup

Dynamic DNS Enable Disable (Settings are invalid when disable)

Service Provider

Host Name

Username

Password

Enable Wildcard Option

Enable Off Line Option (Only applies to custom DNS)

Dynamic DNS Status

User Authentication Result

Last Updated Time

Current Dynamic IP

The following table describes the fields in this screen.

Table 74 Network Setting > DNS > Dynamic DNS

LABEL	DESCRIPTION
Dynamic DNS Setup	
Dynamic DNS	Select Enable to use dynamic DNS.
Service Provider	Select your Dynamic DNS service provider from the drop-down list box.
Host Name	Enter the domain name assigned to your Zyxel Device by your Dynamic DNS provider. You can specify up to two host names in the field separated by a comma (",").
Username	Enter your user name.
Password	Enter the password assigned to you.
Enable Wildcard Option	Select the check box to enable DynDNS Wildcard.
Enable Off Line Option (Only applies to custom DNS)	Check with your Dynamic DNS service provider to have traffic redirected to a URL (that you can specify) while you are off line.
Dynamic DNS Status	
User Authentication Result	This shows Success if the account is correctly set up with the Dynamic DNS provider account.
Last Updated Time	This shows the last time the IP address the Dynamic DNS provider has associated with the hostname was updated.
Current Dynamic IP	This shows the IP address your Dynamic DNS provider has currently associated with the hostname.
Cancel	Click Cancel to exit this screen without saving.
Apply	Click Apply to save your changes.

CHAPTER 14

Firewall

14.1 Firewall Overview

This chapter shows you how to enable the Zyxel Device firewall. Use the firewall to protect your Zyxel Device and network from attacks by hackers on the Internet and control access to it. The firewall:

- allows traffic that originates from your LAN computers to go to all other networks.
- blocks traffic that originates on other networks from going to the LAN.

By default, the Zyxel Device blocks DoS attacks whether the firewall is enabled or disabled.

The following figure illustrates the firewall action. User **A** can initiate an IM (Instant Messaging) session from the LAN to the WAN (1). Return traffic for this session is also allowed (2). However other traffic initiated from the WAN is blocked (3 and 4).

Figure 124 Default Firewall Action

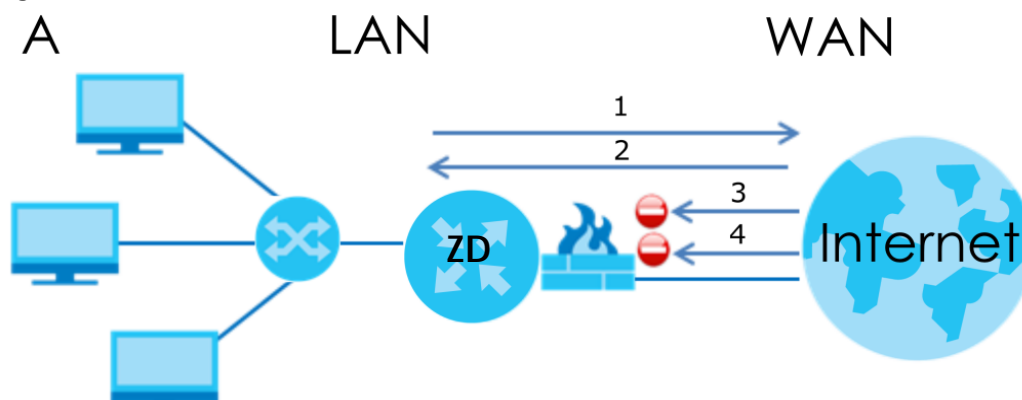

14.1.1 What You Need to Know About Firewall

SYN Attack

A SYN attack floods a targeted system with a series of SYN packets. Each packet causes the targeted system to issue a SYN-ACK response. While the targeted system waits for the ACK that follows the SYN-ACK, it queues up all outstanding SYN-ACK responses on a backlog queue. SYN-ACKs are moved off the queue only when an ACK comes back or when an internal timer terminates the three-way handshake. Once the queue is full, the system will ignore all incoming SYN requests, making the system unavailable for legitimate users.

DoS

Denial-of-Service (DoS) attacks are aimed at devices and networks with a connection to the Internet. Their goal is not to steal information, but to disable a device or network so users no longer have access to network resources. The Zyxel Device is pre-configured to automatically detect and thwart all known DoS attacks.

DoS Thresholds

For DoS attacks, the Zyxel Device uses thresholds to determine when to drop sessions that do not become fully established. These thresholds apply globally to all sessions. You can use the default threshold values, or you can change them to values more suitable to your security requirements.

DDoS

A Distributed Denial-of-Service (DDoS) attack is one in which multiple compromised systems attack a single target, thereby causing denial of service for users of the targeted system.

ICMP

Internet Control Message Protocol (ICMP) is a message control and error-reporting protocol between a host server and a gateway to the Internet. ICMP uses Internet Protocol (IP) datagrams, but the messages are processed by the TCP/IP software and directly apparent to the application user.

LAND Attack

In a LAND attack, hackers flood SYN packets into the network with a spoofed source IP address of the target system. This makes it appear as if the host computer sent the packets to itself, making the system unavailable while the target system tries to respond to itself.

Ping of Death

Ping of Death uses a 'ping' utility to create and send an IP packet that exceeds the maximum 65,536 bytes of data allowed by the IP specification. This may cause systems to crash, hang or reboot.

SPI

Stateful Packet Inspection (SPI) tracks each connection crossing the firewall and makes sure it is valid. Filtering decisions are based not only on rules but also context. For example, traffic from the WAN may only be allowed to cross the firewall in response to a request from the LAN.

14.2 Firewall

Use the firewall to protect your Zyxel Device and network from attacks by hackers on the Internet and control access to it.

14.2.1 What You Can Do in this Chapter

- Use the **General** screen to configure the security level of the firewall on the Zyxel Device ([Section 14.3 on page 199](#)).
- Use the **Protocol** screen to add or remove predefined Internet services and configure firewall rules ([Section 14.4 on page 200](#)).
- Use the **Access Control** screen to view and configure incoming or outgoing filtering rules ([Section 14.5 on page 201](#)).
- Use the **DoS** screen to activate protection against Denial of Service (DoS) attacks ([Section 14.6 on page 204](#)).

14.3 Firewall General Settings

Use the firewall to protect your Zyxel Device and network from attacks by hackers on the Internet and control access to it. Use this screen to set the security level of the firewall on the Zyxel Device. Firewall rules are grouped based on the direction of travel of packets. A higher firewall level means more restrictions on the Internet activities you can perform. Click **Security > Firewall > General** to display the following screen. Use the slider to select the level of firewall protection.

Figure 125 Security > Firewall > General

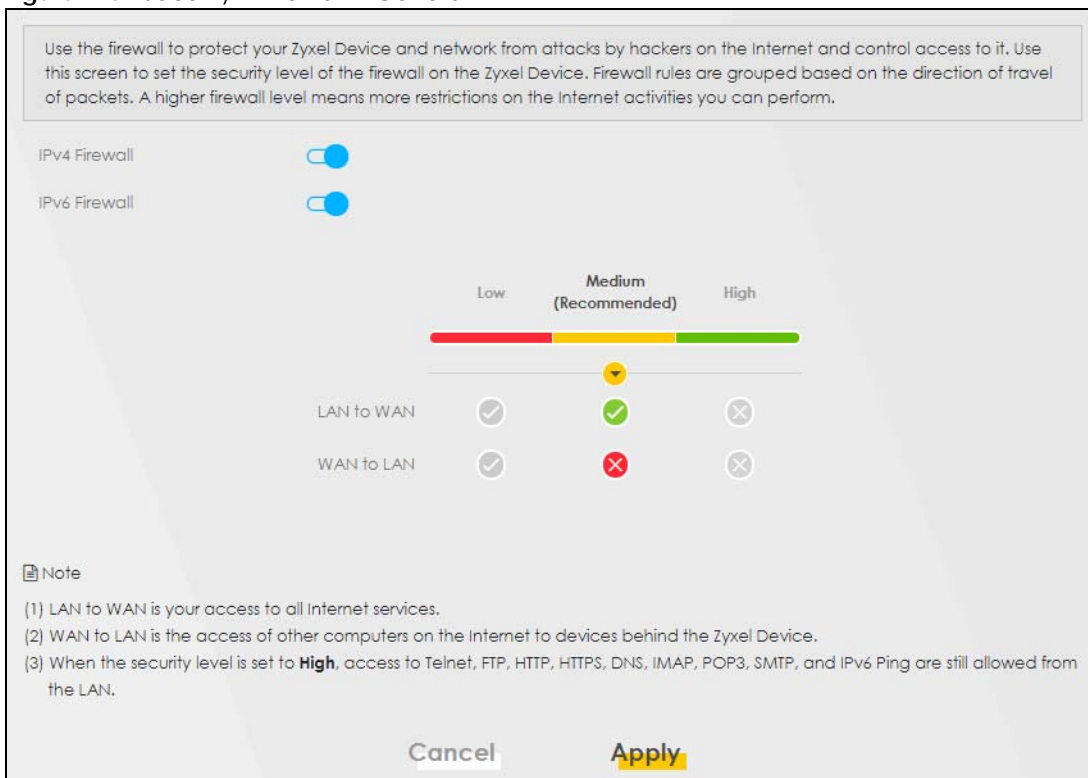

Note: LAN to WAN is your access to all Internet services. WAN to LAN is the access of other computers on the Internet to devices behind the Zyxel Device. When the security level is set to **High**, Telnet, FTP, HTTP, HTTPS, DNS, IMAP, POP3, SMTP, and/or IPv6 ICMPv6 (Ping) traffic from the LAN are still allowed.

The following table describes the labels in this screen.

Table 75 Security > Firewall > General

LABEL	DESCRIPTION
IPv4 Firewall	Enable firewall protection when using IPv4 (Internet Protocol version 4).
IPv6 Firewall	Enable firewall protection when using IPv6 (Internet Protocol version 6).
High	This setting blocks all traffic to and from the Internet. Only local network traffic and LAN to WAN service (Telnet, FTP, HTTP, HTTPS, DNS, POP3, SMTP) is permitted.
Medium	This is the recommended setting. It allows traffic to the Internet but blocks anyone from the Internet from accessing any services on your local network.
Low	This setting allows traffic to the Internet and also allows someone from the Internet to access services on your local network. This would be used with Port Forwarding, Default Server.
Apply	Click this to save your changes.
Cancel	Click this to restore your previously saved settings.

14.4 Protocol (Customized Services)

You can configure customized services and port numbers in the **Protocol** screen. Each set of protocol rules listed in the table are reusable objects to be used in conjunction with ACL rules in the Access Control screen. For a comprehensive list of port numbers and services, visit the IANA (Internet Assigned Number Authority) website. Click **Security > Firewall > Protocol** to display the following screen.

Note: Removing a protocol rule will also remove associated ACL rules.

Figure 126 Security > Firewall > Protocol

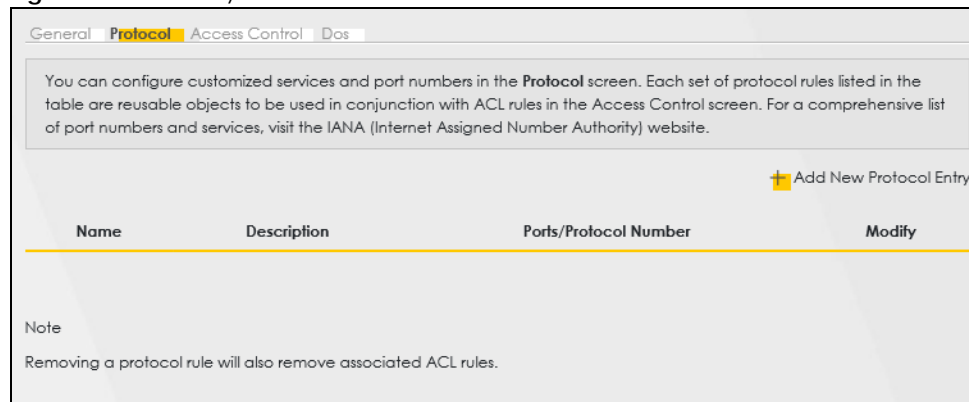

The following table describes the labels in this screen.

Table 76 Security > Firewall > Protocol

LABEL	DESCRIPTION
Add New Protocol Entry	Click this to configure a customized service.
Name	This is the name of your customized service.
Description	This is a description of your customized service.

Table 76 Security > Firewall > Protocol (continued)

LABEL	DESCRIPTION
Ports/Protocol Number	This shows the port number or range and the IP protocol (TCP or UDP) that defines your customized service.
Modify	Click this to edit a customized service.

14.4.1 Add Customized Service

Add a customized rule or edit an existing rule by specifying the protocol and the port numbers. Click **Add New Protocol Entry** in the **Protocol** screen to display the following screen.

Figure 127 Security > Firewall > Protocol: Add New Protocol Entry

The following table describes the labels in this screen.

Table 77 Security > Firewall > Protocol: Add New Protocol Entry

LABEL	DESCRIPTION
Service Name	Type a unique name for your custom port.
Description	Enter a description for your custom port.
Protocol	Choose the protocol (TCP , UDP , ICMP , ICMPv6 , or Other) that defines your customized port from the drop down list box.
Protocol Number	Type a single port number or the range of port numbers (0 – 255) that define your customized service.
OK	Click this to save your changes.
Cancel	Click this to exit this screen without saving.

14.5 Access Control (Rules)

An Access Control List (ACL) rule is a manually-defined rule that can accept, reject, or drop incoming or outgoing packets from your network. This screen displays a list of the configured incoming or outgoing filtering rules. Note the order in which the rules are listed. Click **Security > Firewall > Access Control** to display the following screen.

Note: The ordering of your rules is very important as rules are applied in turn.

Figure 128 Security > Firewall > Access Control



The following table describes the labels in this screen.

Table 78 Security > Firewall > Access Control

LABEL	DESCRIPTION
Rules Storage Space Usage	This read-only bar shows how much of the Zyxel Device's memory is in use for recording firewall rules. When you are using 80% or less of the storage space, the bar is green. When the amount of space used is over 80%, the bar is red.
Add New ACL Rule	Select an index number and click Add New ACL Rule to add a new firewall rule after the selected index number. For example, if you select "6", your new rule becomes number 7 and the previous rule 7 (if there is one) becomes rule 8.
#	This field displays the rule index number. The ordering of your rules is important as rules are applied in turn.
Status	This field displays the status of the ACL rule. A yellow bulb signifies that this ACL rule is active, while a gray bulb signifies that this ACL rule is not active.
Name	This field displays the rule name.
Src IP	This field displays the source IP addresses to which this rule applies.
Dest IP	This field displays the destination IP addresses to which this rule applies.
Service	This field displays the protocol (All, TCP, UDP, TCP/UDP, ICMP, ICMPv6, or any) used to transport the packets for which you want to apply the rule.
Action	Displays whether the firewall silently discards packets (Drop), discards packets and sends a TCP reset packet or an ICMP destination-unreachable message to the sender (Reject), or allow the passage of (Accept) packets that match this rule.
Modify	Click the Edit icon to edit the firewall rule. Click the Delete icon to delete an existing firewall rule.

14.5.1 Add New ACL Rule

Click **Add new ACL rule** or the **Edit** icon next to an existing ACL rule in the **Access Control** screen. The following screen displays. Use this screen to accept, reject, or drop packets based on specified parameters, such as source and destination IP address, IP Type, service, and direction. You can also specify a limit as to how many packets this rule applies to at a certain period of time or specify a schedule for this rule.

Figure 129 Security > Firewall > Access Control > Add New ACL Rule

The screenshot shows the 'Add New ACL Rule' configuration interface. It includes a back arrow, a title 'Add New ACL Rule', and a list of settings:

- Active:** A toggle switch is turned on (blue).
- Filter Name:** An empty text input field.
- Order:** A dropdown menu showing '2'.
- Select Source Device:** A dropdown menu showing 'Specific IP Address'.
- Source IP Address:** A text input field with a hint '/(prefix length)' to its right.
- Select Destination Device:** A dropdown menu showing 'Specific IP Address'.
- Destination IP Address:** A text input field with a hint '/(prefix length)' to its right.
- MAC Address:** A text input field with dashes '- - - - -'.
- IP Type:** A dropdown menu showing 'IPv4'.
- Select Service:** A dropdown menu showing 'Specific Service'.
- Protocol:** A dropdown menu showing 'ALL'.
- Custom Source Port:** A 'Range' selector with input fields '1' and '1' separated by a hyphen.
- Custom Destination Port:** A 'Range' selector with input fields '1' and '1' separated by a hyphen.
- Policy:** A dropdown menu showing 'ACCEPT'.
- Direction:** A dropdown menu showing 'WAN to LAN'.
- Enable Rate Limit:** A toggle switch is turned off (grey).
- Rate Limit:** A text input field, a 'packet(s) per' label, a 'Minute' label, and a '(1-512)' range.
- Scheduler Rules:** A dropdown menu and a yellow 'Add New Rule' button.

At the bottom of the screen are 'Cancel' and 'OK' buttons.

The following table describes the labels in this screen.

Table 79 Security > Firewall > Access Control > Add New ACL Rule

LABEL	DESCRIPTION
Active	Click the Active button to enable this ACL rule. When the switch goes to the right ( , the function is enabled.
Filter Name	Type a unique name for your filter rule.
Order	Assign the order of your rules as rules are applied in turn.
Select Source Device	If you want the source to come from a particular (single) IP, select Specific IP Address . If not, select from a detected device.
Source IP Address	If you selected Specific IP Address in the previous item, enter the source device's IP address here. Otherwise this field will be hidden if you select the detected device.
Select Destination Device	If you want your rule to apply to packets with a particular (single) IP, select Specific IP Address . If not, select a detected device.
Destination IP Address	If you selected Specific IP Address in the previous item, enter the destination device's IP address here. Otherwise this field will be hidden if you select the detected device.
MAC Address	Enter the MAC addresses of the WiFi or wired LAN clients that are allowed access to the Zyxel Device in these address fields. Enter the MAC addresses in a valid MAC address format, that is, six hexadecimal character pairs, for example, 12:34:56:78:9a:bc.

Table 79 Security > Firewall > Access Control > Add New ACL Rule (continued)

LABEL	DESCRIPTION
IP Type	Select between IPv4 or IPv6 . Compared to IPv4 , IPv6 (Internet Protocol version 6), is designed to enhance IP address size and features. The increase in IPv6 address size to 128 bits (from the 32-bit IPv4 address) allows up to 3.4 x 10 ³⁸ IP addresses. The Zyxel Device can use IPv4/IPv6 dual stack to connect to IPv4 and IPv6 networks, and supports IPv6 rapid deployment (6RD).
Select Service	Select a service from the Select Service box.
Protocol	Select the protocol (ALL , TCP/UDP , TCP , UDP , ICMP , or ICMPv6) used to transport the packets for which you want to apply the rule.
Custom Source Port	This is a single port number or the starting port number of a range that defines your rule.
Custom Destination Port	This is a single port number or the ending port number of a range that defines your rule.
Policy	Use the drop-down list box to select whether to discard (Drop), deny and send an ICMP destination-unreachable message to the sender (Reject), or allow the passage of (Accept) packets that match this rule.
Direction	Select WAN to LAN to apply the rule to traffic from WAN to LAN. Select LAN to WAN to apply the rule to traffic from LAN to WAN. Select WAN to Router to apply the rule to traffic from WAN to router. Select LAN to Router to apply the rule to traffic from LAN to router.
OK	Click this to save your changes.
Cancel	Click this to exit this screen without saving.

14.6 DoS

DoS (Denial of Service) attacks can flood your Internet connection with invalid packets and connection requests, using so much bandwidth and so many resources that Internet access becomes unavailable. Use the **DoS** screen to activate protection against DoS attacks.

Click **Security > Firewall > DoS** to display the following screen.

Figure 130 Security > Firewall > DoS

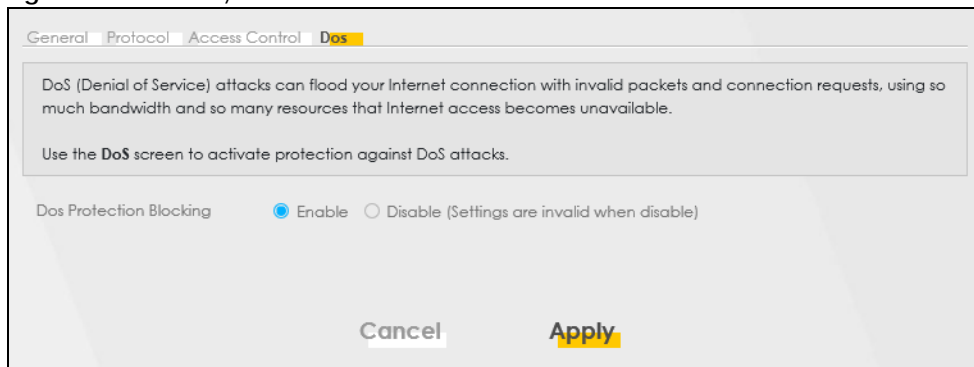

The following table describes the labels in this screen.

Table 80 Security > Firewall > DoS

LABEL	DESCRIPTION
DoS Protection Blocking	Enable this to protect against DoS attacks. The Zyxel Device will drop sessions that surpass maximum thresholds.

Table 80 Security > Firewall > DoS

LABEL	DESCRIPTION
Apply	Click this to save your changes.
Cancel	Click this to restore your previously saved settings.

14.7 Firewall Technical Reference

This section provides some technical background information about the topics covered in this chapter.

14.7.1 Firewall Rules Overview

Your customized rules take precedence and override the Zyxel Device's default settings. The Zyxel Device checks the source IP address, destination IP address and IP protocol type of network traffic against the firewall rules (in the order you list them). When the traffic matches a rule, the Zyxel Device takes the action specified in the rule.

Firewall rules are grouped based on the direction of travel of packets to which they apply:

- LAN to Router
- LAN to WAN
- WAN to LAN
- WAN to Router

By default, the Zyxel Device's stateful packet inspection allows packets traveling in the following directions:

- LAN to Router
 - These rules specify which computers on the LAN can manage the Zyxel Device (remote management).

Note: You can also configure the remote management settings to allow only a specific computer to manage the Zyxel Device.

- LAN to WAN
 - These rules specify which computers on the LAN can access which computers or services on the WAN.

By default, the Zyxel Device's stateful packet inspection drops packets traveling in the following directions:

- WAN to LAN
 - These rules specify which computers on the WAN can access which computers or services on the LAN.

Note: You also need to configure NAT port forwarding (or full featured NAT address mapping rules) to allow computers on the WAN to access devices on the LAN.

- WAN to Router
 - By default the Zyxel Device stops computers on the WAN from managing the Zyxel Device. You could configure one of these rules to allow a WAN computer to manage the Zyxel Device.

Note: You also need to configure the remote management settings to allow a WAN computer to manage the Zyxel Device.

You may define additional rules and sets or modify existing ones but please exercise extreme caution in doing so.

For example, you may create rules to:

- Block certain types of traffic, such as IRC (Internet Relay Chat), from the LAN to the Internet.
- Allow certain types of traffic, such as Lotus Notes database synchronization, from specific hosts on the Internet to specific hosts on the LAN.
- Allow everyone except your competitors to access a web server.
- Restrict use of certain protocols, such as Telnet, to authorized users on the LAN.

These custom rules work by comparing the source IP address, destination IP address and IP protocol type of network traffic to rules set by the administrator. Your customized rules take precedence and override the Zyxel Device's default rules.

14.7.2 Guidelines For Security Enhancement With Your Firewall

- 1 Change the default password through the Web Configurator.
- 2 Think about access control before you connect to the network in any way.
- 3 Limit who can access your router.
- 4 Don't enable any local service (such as telnet or FTP) that you do not use. Any enabled service could present a potential security risk. A determined hacker might be able to find creative ways to misuse the enabled services to access the firewall or the network.
- 5 For local services that are enabled, protect against misuse. Protect by configuring the services to communicate only with specific peers, and protect by configuring rules to block packets for the services at specific interfaces.
- 6 Protect against IP spoofing by making sure the firewall is active.
- 7 Keep the firewall in a secured (locked) room.

14.7.3 Security Considerations

Note: Incorrectly configuring the firewall may block valid access or introduce security risks to the Zyxel Device and your protected network. Use caution when creating or deleting firewall rules and test your rules after you configure them.

Consider these security ramifications before creating a rule:

- 1 Does this rule stop LAN users from accessing critical resources on the Internet? For example, if IRC (Internet Relay Chat) is blocked, are there users that require this service?
- 2 Is it possible to modify the rule to be more specific? For example, if IRC is blocked for all users, will a rule that blocks just certain users be more effective?

- 3** Does a rule that allows Internet users access to resources on the LAN create a security vulnerability? For example, if FTP ports (TCP 20, 21) are allowed from the Internet to the LAN, Internet users may be able to connect to computers with running FTP servers.
- 4** Does this rule conflict with any existing rules?

Once these questions have been answered, adding rules is simply a matter of entering the information into the correct fields in the Web Configurator screens.

CHAPTER 15

MAC Filter

15.1 MAC Filter Overview

You can configure the Zyxel Device to permit access to clients based on their MAC addresses in the **MAC Filter** screen. This applies to wired connections. Every Ethernet device has a unique MAC (Media Access Control) address. The MAC address is assigned at the factory and consists of six pairs of hexadecimal characters, for example, 00:A0:C5:00:00:02. You need to know the MAC addresses of wired LAN client to configure this screen.

15.2 MAC Filter

Enable **MAC Address Filter** and add the host name and MAC address of a wired LAN client to the table if you wish to allow or deny them access to your network. You can choose to enable or disable the filters per entry; make sure that the check box under **Active** is selected if you want to use a filter. Select **Security > MAC Filter**. The screen appears as shown.

Figure 131 Security > MAC Filter

MAC Filter

You can configure the Zyxel Device to permit access to clients based on their MAC addresses in the **MAC Filter** screen. This applies to wired and wireless connections. Every Ethernet device has a unique MAC (Media Access Control) address. The MAC address is assigned at the factory and consists of six pairs of hexadecimal characters, for example, 00:A0:C5:00:00:02. You need to know the MAC addresses of the LAN client to configure this screen.

Enable **MAC Address Filter** and add the host name and MAC address of a LAN client to the table if you wish to allow or deny them access to your network. You can choose to enable or disable the filters per entry; make sure that the check box under **Active** is selected if you want to use a filter.

MAC Address Filter Enable Disable (Settings are invalid when disable)

MAC Restrict Mode Allow Deny

[+ Add New Rule](#)

Set	Active	Host Name	MAC Address	Delete
-----	--------	-----------	-------------	--------

[Cancel](#) [Apply](#)

The following table describes the labels in this screen.

Table 81 Security > MAC Filter

LABEL	DESCRIPTION
MAC Address Filter	Select Enable to activate the MAC filter function.
MAC Restrict Mode	Select Allow to only permit the listed MAC addresses access to the Zyxel Device. Select Deny to permit anyone access to the Zyxel Device except the listed MAC addresses.
Add New Rule	Click the Add button to create a new entry.
Set	This is the index number of the MAC address.
Active	Select Active to enable the MAC filter rule. The rule will not be applied if Allow is not selected under MAC Restrict Mode .
Host Name	Enter the host name of the wired LAN clients that are allowed access to the Zyxel Device.
MAC Address	Enter the MAC addresses of the or wired LAN clients that are allowed access to the Zyxel Device in these address fields. Enter the MAC addresses in a valid MAC address format, that is, six hexadecimal character pairs, for example, 12:34:56:78:9a:bc.
Delete	Click the Delete icon to delete an existing rule.
Cancel	Click Cancel to restore your previously saved settings.
Apply	Click Apply to save your changes.

15.2.1 Add New Rule

You can choose to enable or disable the filters per entry; make sure that the check box under **Active** is selected if you want to use a filter, as shown in the example below. Select **Security > MAC Filter > Add New Rule**. The screen appears as shown.

Figure 132 Security > MAC Filter > Add New Rule

Set	Active	Host Name	MAC Address	Delete
1	<input checked="" type="checkbox"/>	test	BC - 22 - 33 - 11 - 66 - AA	
2	<input checked="" type="checkbox"/>	Test	BC - 88 - 99 - 00 - 11 - 22	

The following table describes the labels in this screen.

Table 82 Security > MAC Filter > Add New Rule

LABEL	DESCRIPTION
Set	This is the index number of the MAC address.
Active	Select Active to enable the MAC filter rule. The rule will not be applied if Allow is not selected under MAC Restrict Mode .
Host Name	Enter the host name of the or wired LAN clients that are allowed access to the Zyxel Device.
MAC Address	Enter the MAC addresses of the or wired LAN clients that are allowed access to the Zyxel Device in these address fields. Enter the MAC addresses in a valid MAC address format, that is, six hexadecimal character pairs, for example, 12:34:56:78:9a:bc.
Delete	Click the Delete icon to delete an existing rule.
Cancel	Click Cancel to restore your previously saved settings.
Apply	Click Apply to save your changes.

CHAPTER 16

Scheduler Rule

16.1 Scheduler Rule Overview

A Scheduler Rule allows you to define time periods and days during which the Zyxel Device allows certain actions.

16.2 Scheduler Rule Settings

Use this screen to view, add, or edit time schedule rules. A scheduler rule is a reusable object that is applied to other features, such as Firewall Access Control.

Click **Security > Scheduler Rule** to open the following screen.

Figure 133 Security > Scheduler Rule

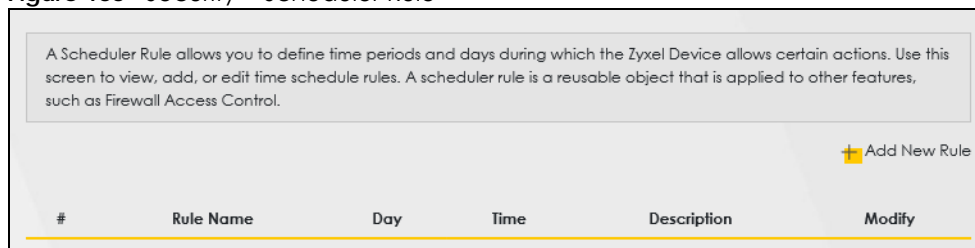

The following table describes the fields in this screen.

Table 83 Security > Scheduler Rule

LABEL	DESCRIPTION
Add New Rule	Click this to create a new rule.
#	This is the index number of the entry.
Rule Name	This shows the name of the rule.
Day	This shows the days on which this rule is enabled.
Time	This shows the period of time on which this rule is enabled.
Description	This shows the description of this rule.
Modify	Click the Edit icon to edit the schedule. Click the Delete icon to delete a scheduler rule. Note: You cannot delete a scheduler rule once it is applied to a certain feature.

16.2.1 Add or Edit a Schedule Rule

Click the **Add New Rule** button in the **Scheduler Rule** screen or click the **Edit** icon next to a schedule rule to open the following screen. Use this screen to configure a restricted access schedule.

Figure 134 Security > Scheduler Rule: Add or Edit

The following table describes the fields in this screen.

Table 84 Security > Scheduler Rule: Add or Edit

LABEL	DESCRIPTION
Rule Name	Enter a name (up to 31 printable English keyboard characters, not including spaces) for this schedule.
Day	Select check boxes for the days that you want the Zyxel Device to perform this scheduler rule.
Time of Day Range	Enter the time period of each day, in 24-hour format, during which the rule will be enforced.
Description	Enter a description for this scheduler rule.
Cancel	Click Cancel to exit this screen without saving.
OK	Click OK to save your changes.

CHAPTER 17

Log

17.1 Log Overview

These screens allow you to determine the categories of events and/or alerts that the Zyxel Device logs and then display these logs or have the Zyxel Device send them to an administrator (through email) or to a syslog server.

17.1.1 What You Can Do in this Chapter

- Use the **System Log** screen to see the system logs ([Section 17.2 on page 213](#)).
- Use the **Security Log** screen to see the security-related logs for the categories that you select ([Section 17.3 on page 214](#)).

17.1.2 What You Need To Know

The following terms and concepts may help as you read this chapter.

Alerts and Logs

An alert is a type of log that warrants more serious attention. They include system errors, attacks (access control) and attempted access to blocked web sites. Some categories such as **System Errors** consist of both logs and alerts. You may differentiate them by their color in the **View Log** screen. Alerts display in red and logs display in black.

Syslog Overview

The syslog protocol allows devices to send event notification messages across an IP network to syslog servers that collect the event messages. A syslog-enabled device can generate a syslog message and send it to a syslog server.

Syslog is defined in RFC 3164. The RFC defines the packet format, content and system log related information of syslog messages. Each syslog message has a facility and severity level. The syslog facility identifies a file in the syslog server. Refer to the documentation of your syslog program for details. The following table describes the syslog severity levels.

Table 85 Syslog Severity Levels

CODE	SEVERITY
0	Emergency: The system is unusable.
1	Alert: Action must be taken immediately.
2	Critical: The system condition is critical.
3	Error: There is an error condition on the system.
4	Warning: There is a warning condition on the system.

Table 85 Syslog Severity Levels (continued)

CODE	SEVERITY
5	Notice: There is a normal but significant condition on the system.
6	Informational: The syslog contains an informational message.
7	Debugging: The message is intended for debug-level purposes.

17.2 System Log

Use the **System Log** screen to see the system logs. You can filter the entries by selecting a severity level and/or category. Click **System Monitor > Log** to open the **System Log** screen.

Figure 135 System Monitor > Log > System Log

The following table describes the fields in this screen.

Table 86 System Monitor > Log > System Log

LABEL	DESCRIPTION
Level	Select a severity level from the drop-down list box. This filters search results according to the severity level you have selected. When you select a severity, the Zyxel Device searches through all logs of that severity or higher.
Category	Select the type of logs to display.
Clear Log	Click this to delete all the logs.
Refresh	Click this to renew the log screen.
Export Log	Click this to export the selected logs.
E-mail Log Now	Click this to send the log files to the email address you specify in the Maintenance > Log Setting screen.
#	This field is a sequential value and is not associated with a specific entry.
Time	This field displays the time the log was recorded.
Facility	The log facility allows you to send logs to different files in the syslog server. Refer to the documentation of your syslog program for more details.
Level	This field displays the severity level of the log that the device is to send to this syslog server.
Category	This field displays the type of the log.
Messages	This field states the reason for the log.

17.3 Security Log

Use the **Security Log** screen to see the security-related logs for the categories that you select. You can filter the entries by selecting a severity level and/or category. Click **System Monitor > Log > Security Log** to open the following screen.

Figure 136 System Monitor > Log > Security Log

The following table describes the fields in this screen.

Table 87 System Monitor > Log > Security Log

LABEL	DESCRIPTION
Level	Select a severity level from the drop-down list box. This filters search results according to the severity level you have selected. When you select a severity, the Zyxel Device searches through all logs of that severity or higher.
Category	Select the type of logs to display.
Clear Log	Click this to delete all the logs.
Refresh	Click this to renew the log screen.
Export Log	Click this to export the selected logs.
E-mail Log Now	Click this to send the log files to the email address you specify in the Maintenance > Log Setting screen.
#	This field is a sequential value and is not associated with a specific entry.
Time	This field displays the time the log was recorded.
Facility	The log facility allows you to send logs to different files in the syslog server. Refer to the documentation of your syslog program for more details.
Level	This field displays the severity level of the log that the device is to send to this syslog server.
Category	This field displays the type of the log.
Messages	This field states the reason for the log.

CHAPTER 18

Traffic Status

18.1 Traffic Status Overview

Use the **Traffic Status** screens to look at the network traffic status and statistics of the WAN/LAN interfaces and NAT.

18.1.1 What You Can Do in this Chapter

- Use the **WAN** screen to view the WAN traffic statistics ([Section 18.2 on page 215](#)).
- Use the **LAN** screen to view the LAN traffic statistics ([Section 18.3 on page 217](#)).
- Use the **NAT** screen to view the NAT status of the Zyxel Device's clients ([Section 18.4 on page 218](#)).

18.2 WAN Status

Click **System Monitor > Traffic Status** to open the **WAN** screen. The figures in this screen show the number of bytes received and sent through the Zyxel Device's WAN interface. The table below shows packet statistics for each WAN interface.

Figure 137 System Monitor > Traffic Status > WAN

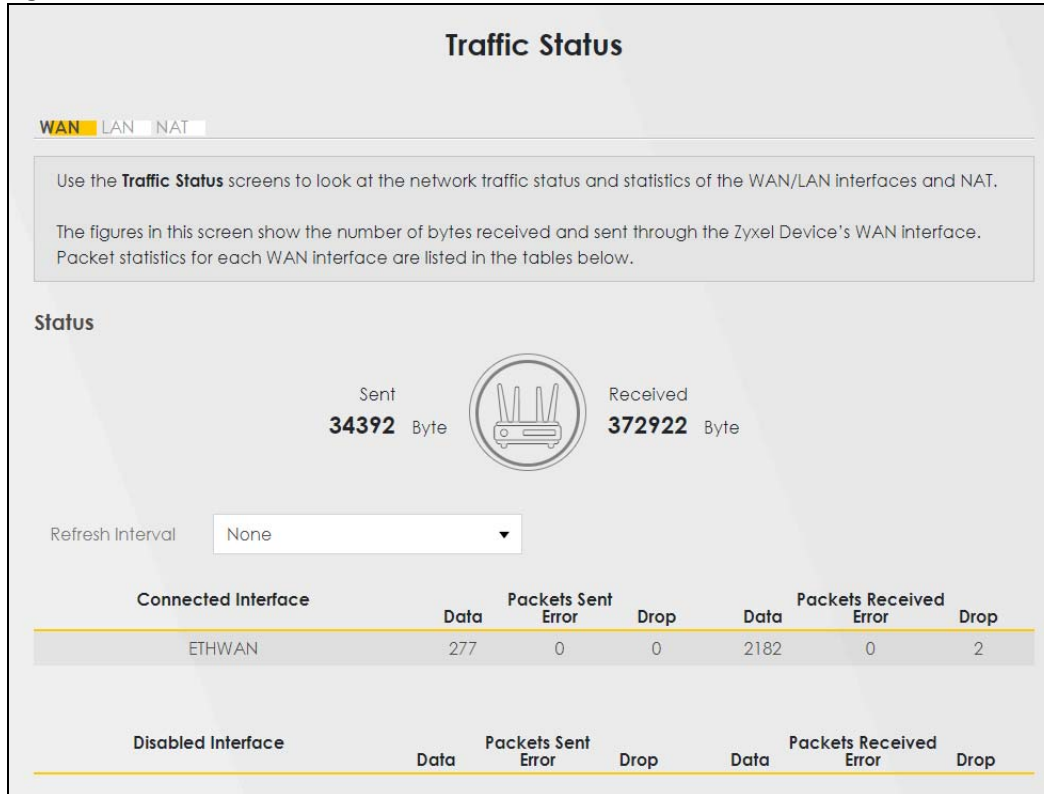

The following table describes the fields in this screen.

Table 88 System Monitor > Traffic Status > WAN

LABEL	DESCRIPTION
Refresh Interval	Select how often you want the Zyxel Device to update this screen.
Connected Interface	This shows the name of the WAN interface that is currently connected.
Packets Sent	
Data	This indicates the number of transmitted packets on this interface.
Error	This indicates the number of frames with errors transmitted on this interface.
Drop	This indicates the number of outgoing packets dropped on this interface.
Packets Received	
Data	This indicates the number of received packets on this interface.
Error	This indicates the number of frames with errors received on this interface.
Drop	This indicates the number of received packets dropped on this interface.
Disabled Interface	This shows the name of the WAN interface that is currently disabled.
Packets Sent	
Data	This indicates the number of transmitted packets on this interface.
Error	This indicates the number of frames with errors transmitted on this interface.
Drop	This indicates the number of outgoing packets dropped on this interface.
Packets Received	
Data	This indicates the number of received packets on this interface.

Table 88 System Monitor > Traffic Status > WAN (continued)

LABEL	DESCRIPTION
Error	This indicates the number of frames with errors received on this interface.
Drop	This indicates the number of received packets dropped on this interface.

18.3 LAN Status

Click **System Monitor > Traffic Status > LAN** to open the following screen. This screen allows you to view packet statistics for each LAN or WLAN interface on the Zyxel Device.

Figure 138 System Monitor > Traffic Status > LAN

The screenshot shows the 'Traffic Status' screen for LAN. It includes a navigation bar with 'WAN', 'LAN', and 'NAT' tabs. A message states: 'This screen allows you to view packet statistics for each LAN or WLAN interface on the Zyxel Device.' Below this is a 'Refresh Interval' dropdown menu set to 'None'. The main content consists of two tables. The first table shows 'Bytes Sent' and 'Bytes Received' for each interface. The second table shows 'Sent (Packet)' and 'Received (Packet)' statistics, including 'Data', 'Error', and 'Drop' counts for each interface.

Interface	LAN1	LAN2	LAN3	2.4G WLAN	5G WLAN
Bytes Sent	5851090	0	0	0	0
Bytes Received	297129	0	0	0	0

Interface	LAN1	LAN2	LAN3	2.4G WLAN	5G WLAN
Sent (Packet)	Data	4042	0	0	0
	Error	0	0	0	0
	Drop	0	0	0	0
Received (Packet)	Data	2813	0	0	0
	Error	0	0	0	0
	Drop	10	0	0	0

The following table describes the fields in this screen.

Table 89 System Monitor > Traffic Status > LAN

LABEL	DESCRIPTION
Refresh Interval	Select how often you want the Zyxel Device to update this screen.
Interface	This shows the LAN or WLAN interface.
Bytes Sent	This indicates the number of bytes transmitted on this interface.
Bytes Received	This indicates the number of bytes received on this interface.
Interface	This shows the LAN or WLAN interfaces.
Sent (Packets)	
Data	This indicates the number of transmitted packets on this interface.
Error	This indicates the number of frames with errors transmitted on this interface.
Drop	This indicates the number of outgoing packets dropped on this interface.
Received (Packets)	
Data	This indicates the number of received packets on this interface.

Table 89 System Monitor > Traffic Status > LAN (continued)

LABEL	DESCRIPTION
Error	This indicates the number of frames with errors received on this interface.
Drop	This indicates the number of received packets dropped on this interface.

18.4 NAT Status

Click **System Monitor > Traffic Status > NAT** to open the following screen. This screen lists the devices that have received an IP address from the Zyxel Device LAN or WLAN interfaces and have ever established a session with the Zyxel Device.

Figure 139 System Monitor > Traffic Status > NAT

The following table describes the fields in this screen.

Table 90 System Monitor > Traffic Status > NAT

LABEL	DESCRIPTION
Refresh Interval	Select how often you want the Zyxel Device to update this screen.
Device Name	This displays the name of the connected host.
IPv4 Address	This displays the IP address of the connected host.
MAC Address	This displays the MAC address of the connected host.
No. of Open Session	This displays the number of NAT sessions currently opened for the connected host.
Total	This displays what percentage of NAT sessions the Zyxel Device can support is currently being used by all connected hosts. You can also see the number of active NAT sessions and the maximum number of NAT sessions the Zyxel Device can support

CHAPTER 19

ARP Table

19.1 ARP Table Overview

Address Resolution Protocol (ARP) is a protocol for mapping an Internet Protocol (IP) address to a physical machine address, known as a Media Access Control (MAC) address, on the local area network.

An IP version 4 address is 32 bits long. MAC addresses are 48 bits long. The ARP table maintains an association between each MAC address and its corresponding IP address.

19.1.1 How ARP Works

When an incoming packet destined for a host device on a local area network arrives at the device, the device's ARP program looks in the ARP table and, if it finds the address, sends it to the device.

If no entry is found for the IP address, ARP broadcasts the request to all the devices on the LAN. The device fills in its own MAC and IP address in the sender address fields, and puts the known IP address of the target in the target IP address field. In addition, the device puts all ones in the target MAC field (FF.FF.FF.FF.FF.FF is the Ethernet broadcast address). The replying device (which is either the IP address of the device being sought or the router that knows the way) replaces the broadcast address with the target's MAC address, swaps the sender and target pairs, and unicasts the answer directly back to the requesting machine. ARP updates the ARP table for future reference and then sends the packet to the MAC address that replied.

19.2 ARP Table

Use the ARP table to view the IPv4-to-MAC address mappings for each device connected to the Zyxel Device. The neighbor table shows the IPv6-to-MAC address mappings of each IPv6 neighbor. To open this screen, click **System Monitor > ARP Table**.

CHAPTER 20

Routing Table

20.1 Routing Table Overview

Routing is based on the destination address only and the Zyxel Device takes the shortest path to forward a packet.

20.2 Routing Table

The table below shows IPv4 and IPv6 routing information. The IPv4 subnet mask is '255.255.255.255' for a host destination and '0.0.0.0' for the default route. The gateway address is written as '*'(IPv4)('/: '(IPv6) if none is set.

Click **System Monitor > Routing Table** to open the following screen.

Figure 141 System Monitor > Routing Table

Routing Table					
Routing is based on the destination address only and the Zyxel Device takes the shortest path to forward a packet.					
The table below shows IPv4 and IPv6 routing information. The IPv4 subnet mask is '255.255.255.255' for a host destination and '0.0.0.0' for the default route. The gateway address is written as '*' (IPv4) / ':' (IPv6) if none is set.					
Destination: This indicates the destination IPv4 address or IPv6 address and prefix of this route.					
Gateway: This indicates the IPv4 address or IPv6 address of the gateway that helps forward this route's traffic.					
Subnet Mask: This indicates the destination subnet mask of the IPv4 route.					
Flag: This indicates the route status.					
U-Up: The route is up.					
I-Reject: The route is blocked and will force a route lookup to fail.					
G-Gateway: The route uses a gateway to forward traffic.					
H-Host: The target of the route is a host.					
R-Reinstate: The route is reinstated for dynamic routing.					
D-Dynamic (redirect): The route is dynamically installed by a routing daemon or redirect.					
M-Modified (redirect): The route is modified from a routing daemon or redirect.					
Metric: The metric represents the "cost of transmission". A router determines the best route for transmission by choosing a path with the lowest "cost". The smaller the number, the lower the "cost".					
Interface: This indicates the name of the interface through which the route is forwarded.					
IPv4 Routing Table					
Destination	Gateway	Subnet Mask	Flag	Metric	Interface
0.0.0.0	0.0.0.0	255.255.0.0	U	0	lo
192.168.1.0/24	0.0.0.0	255.255.255.0	U	0	br0
192.168.1.1	0.0.0.0	255.0.0.0	U	0	br0
IPv6 Routing Table					
Destination	Gateway	Flag	Metric	Interface	
fe80::/64	::	U	256	eth0	
fe80::/64	::	U	256	eth0.1	
fe80::/64	::	U	256	eth0.2	
fe80::/64	::	U	256	eth0.3	
fe80::/64	::	U	256	eth0.4	
fe80::/64	::	U	256	nas10	
fe80::/64	::	U	256	br0	
fe80::/64	::	U	256	ra0	
fe80::/64	::	U	256	ra1	
fe80::/64	::	U	256	ra2	
fe80::/64	::	U	256	ra3	
fe80::/64	::	U	256	rai0	
fe80::/64	::	U	256	rai1	
fe80::/64	::	U	256	rai2	
fe80::/64	::	U	256	rai3	
fe80::/64	::	U	256	rai5	
::1/128	::	U	0	lo	

The following table describes the labels in this screen.

Table 92 System Monitor > Routing Table

LABEL	DESCRIPTION
IPv4 / IPv6 Routing Table	
Destination	This indicates the destination IPv4 address or IPv6 address and prefix of this route.
Gateway	This indicates the IPv4 address or IPv6 address of the gateway that helps forward this route's traffic.
Subnet Mask	This indicates the destination subnet mask of the IPv4 route.

Table 92 System Monitor > Routing Table (continued)

LABEL	DESCRIPTION
Flag	<p>This indicates the route status.</p> <p>U-Up: The route is up.</p> <p>!-Reject: The route is blocked and will force a route lookup to fail.</p> <p>G-Gateway: The route uses a gateway to forward traffic.</p> <p>H-Host: The target of the route is a host.</p> <p>R-Reinstate: The route is reinstated for dynamic routing.</p> <p>D-Dynamic (redirect): The route is dynamically installed by a routing daemon or redirect.</p> <p>M-Modified (redirect): The route is modified from a routing daemon or redirect.</p>
Metric	<p>The metric represents the "cost of transmission." A router determines the best route for transmission by choosing a path with the lowest "cost." The smaller the number, the lower the "cost."</p>
Interface	<ul style="list-style-type: none"> • brx indicates a LAN interface where x can be 0 – 3 to represent LAN1 to LAN4 respectively. • ethx indicates an Ethernet WAN interface using IPoE or in bridge mode. • ppp0 indicates a WAN interface using PPPoE. • wlx indicates a wireless interface where x can be 0 – 1.

CHAPTER 21

WLAN Station Status

21.1 WLAN Station Status Overview

Click **System Monitor > WLAN Station Status** to open the following screen. Use this screen to view information and status of the wireless stations (WiFi clients) that are currently associated with the Zyxel Device. Being associated means that a WiFi client (for example, your computer with a WiFi network card installed) has connected successfully to an AP (or WiFi router) using the same SSID, channel, and WiFi security settings.

Figure 142 System Monitor > WLAN Station Status

The screenshot shows a web interface with the following structure:

- A header box: "WLAN Station Status lists associated WiFi clients."
- A section titled "WLAN 2.4G Station Status" containing a table with columns: #, MAC Address, Rate (Mbps), RSSI (dBm), SNR, and Level.
- A section titled "WLAN 5G Station Status" containing a table with columns: #, MAC Address, Rate (Mbps), RSSI (dBm), SNR, and Level.

The following table describes the labels in this screen.

Table 93 System Monitor > WLAN Station Status

LABEL	DESCRIPTION
#	This is the index number of an associated wireless station.
MAC Address	This field displays the MAC address of an associated wireless station.
Rate (Mbps)	This field displays the transmission rate of WiFi traffic between an associated wireless station and the Zyxel Device.
RSSI (dBm)	The RSSI (Received Signal Strength Indicator) field shows the WiFi signal strength of the station's wireless connection. The normal range is -30dBm to -79dBm. If the value drops below -80dBm, try moving the associated wireless station closer to the Zyxel Device to get better signal strength.

Table 93 System Monitor > WLAN Station Status (continued)

LABEL	DESCRIPTION
SNR	<p>The Signal-to-Noise Ratio (SNR) is the ratio between the received signal power and the received noise power. The greater the number, the better the quality of WiFi.</p> <p>The normal range is 15 to 40. If the value drops below 15, try moving the associated wireless station closer to the Zyxel Device to get better quality WiFi.</p>
Level	<p>This field displays a number which represents the strength of the WiFi signal between an associated wireless station and the Zyxel Device. The Zyxel Device uses the RSSI and SNR values to determine the strength of the WiFi signal.</p> <p>5 means the Zyxel Device is receiving an excellent WiFi signal.</p> <p>4 means the Zyxel Device is receiving a very good WiFi signal.</p> <p>3 means the Zyxel Device is receiving a weak WiFi signal,</p> <p>2 means the Zyxel Device is receiving a very weak WiFi signal.</p> <p>1 means the Zyxel Device is not receiving a WiFi signal.</p>

CHAPTER 22

Operating Mode

22.1 Operating Mode Overview

Use this screen to select how you want to use your Zyxel Device. The Operating Mode function lets you configure your Zyxel Device as a router or access point. You can choose between **Router** Mode, and **Access Point (AP)** Mode depending on your network topology and the features you require from your Zyxel Device.

Click **Maintenance > Operating Mode** to show the following screen. The Zyxel Device has the following operating modes:

- **Router**: This is the Zyxel Device's default mode. In this mode, the Zyxel Device routes traffic between a local network and another network such as the Internet.
- **Access Point (AP)**: Use this mode if you already have a router in your network and want to use the Zyxel Device as an access point to bridge a wired network (LAN) and another LAN or wireless LAN (WLAN) in the same subnet.

Figure 143 Maintenance > Operating Mode

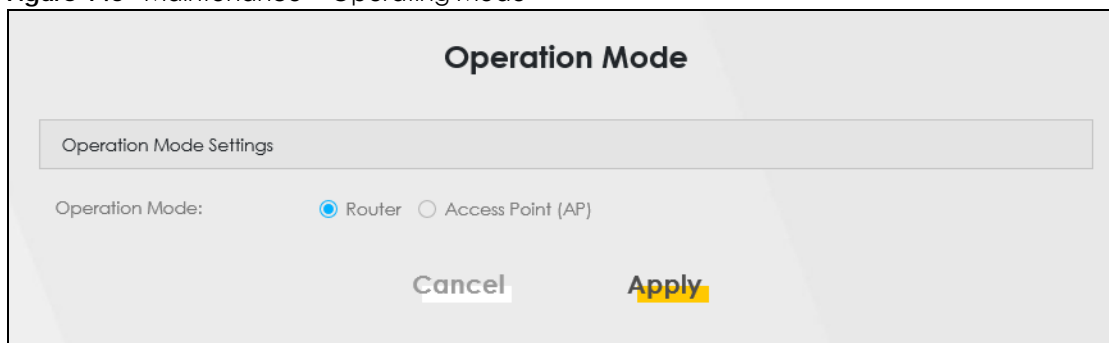

The following table describes the labels in this screen.

Table 94 Maintenance > Operating Mode

LABEL	DESCRIPTION
Operating Mode Settings	
Operating Mode	Select Router to use the Zyxel Device as a router. Select Access Point (AP) to use the Zyxel Device as an access point.
Cancel	Click Cancel to restore your previously saved settings.
Apply	Click Apply to save your changes.

CHAPTER 23

System

23.1 System Overview

Use this screen to name your Zyxel Device (Host) and give it an associated domain name for identification purposes.

23.2 System

Click **Maintenance > System** to open the following screen. Assign a unique name to the Zyxel Device so it can be easily recognized on your network. You can use up to 30 alphanumeric characters except [?], [|], ['], ["] or [.].

Figure 144 Maintenance > System

System

Use this screen to name your Zyxel Device (Host) and give it an associated domain name for identification purposes.

Assign a unique name to the Zyxel Device so it can be easily recognized on your network. You can use up to 30 characters, including spaces.

Host Name: NBG7510

Domain Name: home

LED Active:

Cancel Apply

The following table describes the labels in this screen.

Table 95 Maintenance > System

LABEL	DESCRIPTION
Host Name	Type a host name for your Zyxel Device. Enter a descriptive name of up to 30 alphanumeric characters except [?], [], ['], ["] or [.]. For some models, the supported maximum input length is 16 alphanumeric characters.
Domain Name	Type a domain name for your host Zyxel Device.
Cancel	Click Cancel to abandon this screen without saving.
Apply	Click Apply to save your changes.

CHAPTER 24

User Account

24.1 User Account Overview

In the **User Account** screen, you can view the settings of the “admin” and other user accounts that you use to log into the Zyxel Device to manage it.

24.2 User Account

Click **Maintenance > User Account** to open the following screen. Use this screen to create or manage user accounts and their privileges on the Zyxel Device.

Figure 145 Maintenance > User Account

#	Active	User Name	Retry Times	Idle Timeout	Lock Period	Group	Remote Privilege	Modify
1	<input checked="" type="checkbox"/>	admin	3	60	5	Administrator	LAN,WAN	

The following table describes the labels in this screen.

Table 96 Maintenance > User Account

LABEL	DESCRIPTION
#	This is the index number.
Active	This indicates whether the user account is active or not. The check box is selected when the user account is enabled. It is cleared when it is disabled.
User Name	This displays the name of the account used to log into the Zyxel Device Web Configurator.
Retry Times	This displays the number of times consecutive wrong passwords can be entered for this account. 0 means there is no limit.
Idle Timeout	This displays the length of inactive time before the Zyxel Device will automatically log the user out of the Web Configurator.
Lock Period	This field displays the length of time a user must wait before attempting to log in again after a number of consecutive wrong passwords have been entered as defined in Retry Times .
Group	This field displays whether this user has Administrator or User privileges.

Table 96 Maintenance > User Account (continued)

LABEL	DESCRIPTION
Remote Privilege	This field displays whether this user can access the Zyxel Device with HTTP, Telnet or SSH through the WAN, LAN or LAN/WAN .
Modify	Click the Edit icon to configure the entry.
Cancel	Click Cancel to restore your previously saved settings.
Apply	Click Apply to save your changes.

CHAPTER 25

Remote Management

25.1 Remote Management Overview

Remote management controls through which interfaces, which web services (such as HTTP, HTTPS, FTP, Telnet, SSH and Ping) can access the Zyxel Device.

Note: The Zyxel Device is managed using the Web Configurator.

25.1.1 What You Can Do in this Chapter

- Use the **MGMT Services** screen to allow various approaches to access the Zyxel Device remotely from a WAN and/or LAN connection ([Section 25.2 on page 230](#)).
- Use the **Trust Domain** screen to enable users to permit access from local management services by entering specific IP addresses ([Section 25.3 on page 232](#)).

25.2 MGMT Services

Use this screen to configure the interfaces through which services can access the Zyxel Device. You can also specify service port numbers computers must use to connect to the Zyxel Device. Click **Maintenance > Remote Management > MGMT Services** to open the following screen.

Figure 146 Maintenance > Remote Management > MGMT Services

Remote Management

MGMT Services Trust Domain

Use this screen to configure the interfaces through which services can access the Zyxel Device. You can also specify service port numbers computers must use to connect to the Zyxel Device.

Service Control

WAN Interface used for services Any_WAN Multi_WAN

ETHWAN

Service	LAN	WLAN	WAN	Trust Domain	Port
HTTP	<input checked="" type="checkbox"/> Enable	<input checked="" type="checkbox"/> Enable	<input type="checkbox"/> Enable	<input type="checkbox"/> Enable	80
HTTPS	<input checked="" type="checkbox"/> Enable	<input checked="" type="checkbox"/> Enable	<input type="checkbox"/> Enable	<input type="checkbox"/> Enable	443
FTP	<input type="checkbox"/> Enable	<input type="checkbox"/> Enable	<input type="checkbox"/> Enable	<input type="checkbox"/> Enable	21
TELNET	<input type="checkbox"/> Enable	<input type="checkbox"/> Enable	<input type="checkbox"/> Enable	<input type="checkbox"/> Enable	23
SSH	<input type="checkbox"/> Enable	<input type="checkbox"/> Enable	<input type="checkbox"/> Enable	<input type="checkbox"/> Enable	22
SNMP	<input type="checkbox"/> Enable	<input type="checkbox"/> Enable	<input type="checkbox"/> Enable	<input type="checkbox"/> Enable	161
PING	<input checked="" type="checkbox"/> Enable	<input checked="" type="checkbox"/> Enable	<input type="checkbox"/> Enable	<input type="checkbox"/> Enable	

The following table describes the fields in this screen.

Table 97 Maintenance > Remote Management > MGMT Services

LABEL	DESCRIPTION
Service Control	
WAN Interface used for services	Select Any_WAN to have the Zyxel Device automatically activate the remote management service when any WAN connection is up. Select Multi_WAN and then select one or more WAN connections to have the Zyxel Device activate the remote management service when the selected WAN connections are up.
ETHWAN	Enable the Ethernet WAN connection configured in Network Setting > Broadband > Ethernet WAN to access the service on the Zyxel Device.
Service	This is the service you may use to access the Zyxel Device.
LAN	Select the Enable check box for the corresponding services that you want to allow access to the Zyxel Device from the LAN.
WLAN	Select the Enable check box for the corresponding services that you want to allow access to the Zyxel Device from the WLAN.
WAN	Select the Enable check box for the corresponding services that you want to allow access to the Zyxel Device from all WAN connections.
Trust Domain	Select the Enable check box for the corresponding services that you want to allow access to the Zyxel Device from the trusted host IP address.
Port	You may change the server port number for a service if needed, however you must use the same port number in order to use that service for remote management.

Table 97 Maintenance > Remote Management > MGMT Services

LABEL	DESCRIPTION
Apply	Click Apply to save your changes back to the Zyxel Device.
Cancel	Click Cancel to restore your previously saved settings.

25.3 Trust Domain

Use this screen to view a list of public IP addresses which are allowed to access the Zyxel Device through the services configured in the **Maintenance > Remote Management > MGMT Services** screen. Click **Maintenance > Remote Management > Trust Domain** to open the following screen.

Note: Enter the IP address of the management station permitted to access the local management services. If specific services from the trusted hosts are allowed access but the trust domain list is empty, all public IP addresses can access the Zyxel Device from the WAN using the specified services.

Figure 147 Maintenance > Remote Management > Trust Domain

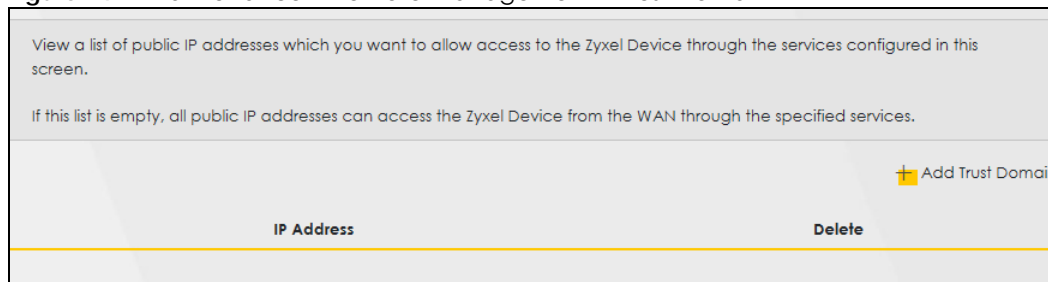

The following table describes the fields in this screen.

Table 98 Maintenance > Remote Management > Trust Domain

LABEL	DESCRIPTION
Add Trust Domain	Click this to add a trusted host IP address.
IP Address	This field shows a trusted host IP address.
Delete	Click the Delete icon to remove the trusted host IP address.

25.4 Add Trust Domain

Use this screen to add a public IP addresses or a complete domain name of a device which is allowed to access the Zyxel Device. Enter the IP address of the management station permitted to access the local management services. If specific services from the trusted-hosts are allowed access but the trust domain list is empty, all public IP addresses can access the Zyxel Device from the WAN using the specified services.

Click the **Add Trust Domain** button in the **Maintenance > Remote Management > Trust Domain** screen to open the following screen.

Figure 148 Maintenance > Remote Management > Trust Domain > Add Trust Domain

The following table describes the fields in this screen.

Table 99 Maintenance > Remote Management > Trust Domain > Add Trust Domain

LABEL	DESCRIPTION
IP Address	Enter a public IPv4/IPv6 IP address which is allowed to access the service on the Zyxel Device from the WAN.
OK	Click OK to save your changes back to the Zyxel Device.
Cancel	Click Cancel to restore your previously saved settings.

CHAPTER 26

Time Settings

26.1 Time Settings Overview

This chapter shows you how to configure system related settings, such as system date and time.

26.2 Time

For effective scheduling and logging, the Zyxel Device system time must be accurate. Use this screen to configure the Zyxel Device's time based on your local time zone. You can enter a time server address, select the time zone where the Zyxel Device is physically located, and configure Daylight Savings settings if needed.

To change your Zyxel Device's time and date, click **Maintenance > Time**. The screen appears as shown.

Figure 149 Maintenance > Time

Configure the Zyxel Device's time based on your local time zone. You can add a time server address, select your time zone, and configure Daylight Savings if your location uses it.

Current Date/Time

Current Time 14:21:53
Current Date 2019-02-27

Time and Date Setup

Time Protocol SNTP (RFC-1769)

First Time Server Address pool.ntp.org
Second Time Server Address clock.nyc.he.net
Third Time Server Address clock.sjc.he.net
Fourth Time Server Address None
Fifth Time Server Address None

Time Zone

Time Zone (GMT+08:00) Taipei

Daylight Savings

Active

Start Rule

Day 1 in
 Last Sunday in

Month March
Hour 2 0

End Rule

Day 1 in
 Last Sunday in

Month October
Hour 3 0

Cancel Apply

The following table describes the fields in this screen.

Table 100 Maintenance > Time

LABEL	DESCRIPTION
Current Date/Time	
Current Time	This displays the time of your Zyxel Device. Each time you reload this screen, the Zyxel Device synchronizes the time with the time server.
Current Date	This displays the date of your Zyxel Device. Each time you reload this screen, the Zyxel Device synchronizes the date with the time server.
Time and Date Setup	
Time Protocol	This displays the time protocol used by your Zyxel Device.

Table 100 Maintenance > Time (continued)

LABEL	DESCRIPTION
First – Fifth Time Server Address	<p>Select an NTP time server from the drop-down list box.</p> <p>Otherwise, select Other and enter the IP address or URL (up to 29 extended ASCII characters in length) of your time server.</p> <p>Select None if you do not want to configure the time server.</p> <p>Check with your ISP/network administrator if you are unsure of this information.</p>
Time Zone	
Time zone	Choose the time zone of your location. This will set the time difference between your time zone and Greenwich Mean Time (GMT).
Daylight Savings	Daylight Saving Time is a period from late spring to early fall when many countries set their clocks ahead of normal local time by one hour to give more daytime light in the evening.
Active	Click this switch to enable or disable Daylight Saving Time. When the switch turns blue  , the function is enabled. Otherwise, it is not.
Start Rule	<p>Configure the day and time when Daylight Saving Time starts if you enabled Daylight Saving. You can select a specific date in a particular month or a specific day of a specific week in a particular month. The Time field uses the 24 hour format. Here are a couple of examples:</p> <p>Daylight Saving Time starts in most parts of the United States on the second Sunday of March. Each time zone in the United States starts using Daylight Saving Time at 2 A.M. local time. So in the United States, set the day to Second, Sunday, the month to March and the time to 2 in the Hour field.</p> <p>Daylight Saving Time starts in the European Union on the last Sunday of March. All of the time zones in the European Union start using Daylight Saving Time at the same moment (1 A.M. GMT or UTC). So in the European Union you would set the day to Last, Sunday and the month to March. The time you select in the o'clock field depends on your time zone. In Germany for instance, you would select 2 in the Hour field because Germany's time zone is one hour ahead of GMT or UTC (GMT+1).</p>
End Rule	<p>Configure the day and time when Daylight Saving Time ends if you enabled Daylight Saving. You can select a specific date in a particular month or a specific day of a specific week in a particular month. The Time field uses the 24 hour format. Here are a couple of examples:</p> <p>Daylight Saving Time ends in the United States on the first Sunday of November. Each time zone in the United States stops using Daylight Saving Time at 2 A.M. local time. So in the United States you would set the day to First, Sunday, the month to November and the time to 2 in the Hour field.</p> <p>Daylight Saving Time ends in the European Union on the last Sunday of October. All of the time zones in the European Union stop using Daylight Saving Time at the same moment (1 A.M. GMT or UTC). So in the European Union you would set the day to Last, Sunday, and the month to October. The time you select in the o'clock field depends on your time zone. In Germany for instance, you would select 2 in the Hour field because Germany's time zone is one hour ahead of GMT or UTC (GMT+1).</p>
Cancel	Click Cancel to exit this screen without saving.
Apply	Click Apply to save your changes.

CHAPTER 27

Email Notification

27.1 Email Notification Overview

A mail server is an application or a computer that can receive, forward and deliver email messages.

To have the Zyxel Device send reports, logs or notifications through email, you must specify an email server and the email addresses of the sender and receiver.

27.2 Email Notification

Use this screen to view, remove and add email account information on the Zyxel Device. This account can be set to send email notifications for logs.

Click **Maintenance > E-mail Notification** to open the **E-mail Notification** screen.

Note: The default port number of the mail server is 25.

Figure 150 Maintenance > E-mail Notification

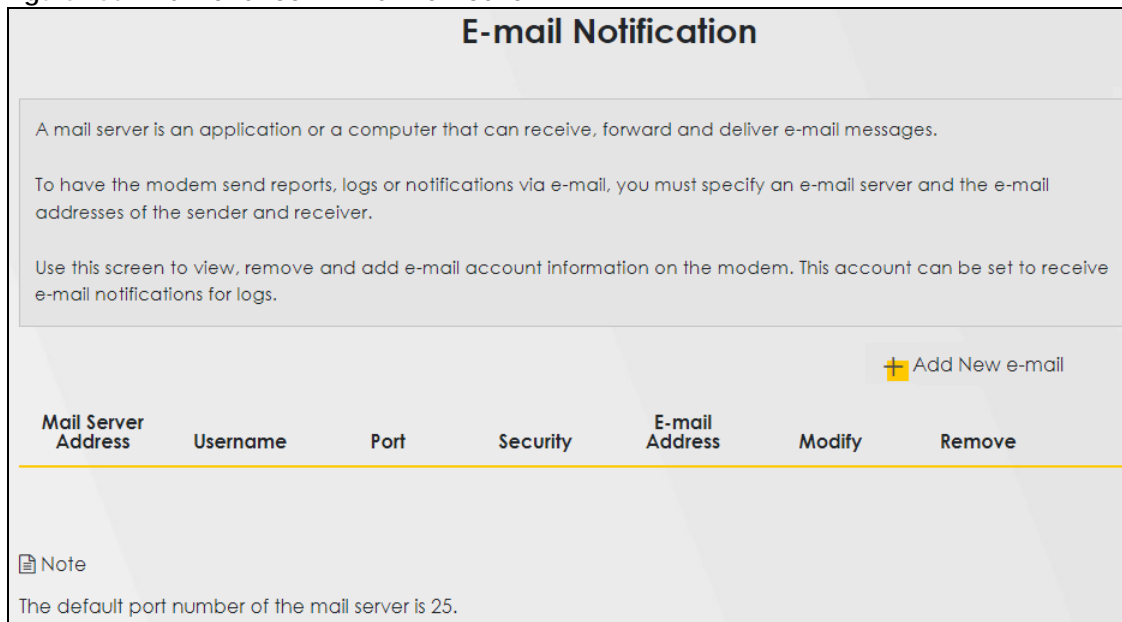

E-mail Notification

A mail server is an application or a computer that can receive, forward and deliver e-mail messages.

To have the modem send reports, logs or notifications via e-mail, you must specify an e-mail server and the e-mail addresses of the sender and receiver.

Use this screen to view, remove and add e-mail account information on the modem. This account can be set to receive e-mail notifications for logs.

[+ Add New e-mail](#)

Mail Server Address	Username	Port	Security	E-mail Address	Modify	Remove
---------------------	----------	------	----------	----------------	--------	--------

Note
The default port number of the mail server is 25.

The following table describes the labels in this screen.

Table 101 Maintenance > E-mail Notification

LABEL	DESCRIPTION
Add New e-mail	Click this button to create a new entry (up to 32 can be created).
Mail Server Address	This displays the server name or the IP address of the mail server.
Username	This displays the user name of the sender's mail account.
Port	This field displays the port number of the mail server.
Security	This field displays the protocol used for encryption.
E-mail Address	This field displays the email address that you want to be in the from or sender line of the email that the Zyxel Device sends.
Modify	Click the Edit icon to configure the entry. Click the Delete icon to remove the entry.
Remove	Click this button to delete the selected entries.

27.2.1 E-mail Notification Edit

Click the **Add** button in the **E-mail Notification** screen. Use this screen to configure the required information for sending email through a mail server.

Figure 151 Maintenance > E-mail Notification > Add

The following table describes the labels in this screen.

Table 102 Maintenance > E-mail Notification > Add

LABEL	DESCRIPTION
Mail Server Address	Enter the server name or the IP address of the mail server for the email address specified in the Account e-mail Address field. If this field is left blank, reports, logs or notifications will not be sent through email.
Port	Enter the same port number here as is on the mail server for mail traffic.
Authentication Username	Enter the user name (up to 32 characters). This is usually the user name of a mail account you specified in the Account email Address field.

Table 102 Maintenance > E-mail Notification > Add (continued)

LABEL	DESCRIPTION
Authentication Password	Enter the password associated with the user name above.
Account e-mail Address	Enter the email address that you want to be in the from or sender line of the email notification that the Zyxel Device sends. If you activate SSL/TLS authentication, the email address must be able to be authenticated by the mail server as well.
Connection Security	Select SSL to use Secure Sockets Layer (SSL) or Transport Layer Security (TLS) if you want encrypted communications between the mail server and the Zyxel Device. Select STARTTLS to upgrade a plain text connection to a secure connection using SSL/TLS.
Cancel	Click this button to begin configuring this screen afresh.
OK	Click this button to save your changes and return to the previous screen.

CHAPTER 28

Log Setting

28.1 Log Setting Overview

You can configure where the Zyxel Device sends logs and which type of logs the Zyxel Device records in the **Logs Setting** screen.

28.2 Log Setting

Use this screen to configure where the Zyxel Device sends logs, and which type of logs the Zyxel Device records.

If you have a server that is running a syslog service, you can also save log files to it by enabling **Syslog Logging**, and then entering the IP address of the server in the **Syslog Server** field. Select **Remote** to store logs on the syslog server, or select **Local File** to store logs on the Zyxel Device. Select **Local File and Remote** to store logs on both the Zyxel Device and the syslog server. To change your Zyxel Device's log settings, click **Maintenance > Log Setting**. The screen appears as shown.

Figure 152 Maintenance > Log Setting

Use this screen to configure where the Zyxel Device sends logs, and which type of logs the Zyxel Device records.

If you have a server that is running a syslog service, you can also save log files to it by enabling **Syslog Logging** and then entering the IP address of the server in the **Syslog Server** field. Select **Remote** to store logs on the syslog server, or select **Local File** to store logs on the Zyxel Device. Select **Local File and Remote** to store logs on both the Zyxel Device and on the syslog server.

Syslog Setting

Syslog Logging

Mode: Local File

Syslog Server: 0.0.0.0 (Server NAME or IPv4/IPv6 Address)

UDP Port: 514 (Server Port)

E-mail Log Settings

E-mail Log Settings

Mail Account: Select one account

System Log Mail Subject: _____

Security Log Mail Subject: _____

Send Log to: _____ (E-Mail Address)

Send Alarm to: _____ (E-Mail Address)

Alarm Interval: 60 (seconds)

Active Log

System Log

- WAN-DHCP
- DHCP Server
- PPPoE
- TR-069
- HTTP
- UPNP
- System
- ACL
- Wireless
- IGMP

Security Log

- Account
- Attack
- Firewall
- MAC Filter

Cancel Apply

The following table describes the fields in this screen.

Table 103 Maintenance > Log Setting

LABEL	DESCRIPTION
Syslog Settings	
Syslog Logging	Click the switch (it will turn blue) to enable syslog logging.
Mode	Select Remote to have the Zyxel Device send it to an external syslog server. Select Local File to have the Zyxel Device save the log file on the Zyxel Device itself. Select Local File and Remote to have the Zyxel Device save the log file on the Zyxel Device itself and send it to an external syslog server. Note: A warning appears upon selecting Remote or Local File and Remote . Just click OK to continue.
Syslog Server	Enter the server name or IP address of the syslog server that will log the selected categories of logs.
UDP Port	Enter the port number used by the syslog server.
E-mail Log Settings	

Table 103 Maintenance > Log Setting (continued)

LABEL	DESCRIPTION
E-mail Log Settings	Click the switch (it will turn blue) to allow the sending through email the system and security logs to the email address specified in Send Log to . Note: Make sure that the Mail Server Address field is not left blank in the Maintenance > E-mail Notifications screen.
Mail Account	Select a server specified in Maintenance > E-mail Notifications to send the logs to.
System Log Mail Subject	This field allows you to enter a descriptive name for the system log email (for example Zyxel System Log). Up to 127 characters are allowed for the System Log Mail Subject including special characters inside the square brackets [!#%()*+,-./:=?@[\\{}~].
Security Log Mail Subject	This field allows you to enter a descriptive name for the security log email (for example Zyxel Security Log). Up to 127 characters are allowed for the Security Log Mail Subject including special characters inside the square brackets [!#%()*+,-./:=?@[\\{}~].
Send Log to	This field allows you to enter the log's designated email recipient. The log's format is plain text file sent as an email attachment.
Send Alarm to	This field allows you to enter the alarm's designated e-mail recipient. The alarm's format is plain text file sent as an email attachment.
Alarm Interval	Select the frequency of showing of the alarm.
Active Log	
System Log	Select the categories of System Logs that you want to record.
Security Log	Select the categories of Security Logs that you want to record.
Apply	Click Apply to save your changes.
Cancel	Click Cancel to restore your previously saved settings.

28.2.1 Example Email Log

An 'End of Log' message displays for each mail in which a complete log has been sent. The following is an example of a log sent by email.

- You may edit the subject title.
- The date format here is Day-Month-Year.
- The date format here is Month-Day-Year. The time format is Hour-Minute-Second.
- 'End of Log' message shows that a complete log has been sent.

Figure 153 Email Log Example

```

Subject:
    Firewall Alert From
Date:
    Fri, 07 Apr 2000 10:05:42
From:
    user@zyxel.com
To:
    user@zyxel.com
1|Apr 7 00 |From:192.168.1.1      To:192.168.1.255  |default policy |forward
  |09:54:03 |UDP      src port:00520 dest port:00520  |<1,00>        |
2|Apr 7 00  |From:192.168.1.131   To:192.168.1.255  |default policy |forward
  |09:54:17  |UDP      src port:00520 dest port:00520  |<1,00>        |
3|Apr 7 00  |From:192.168.1.6     To:10.10.10.10    |match          |forward
  |09:54:19  |UDP      src port:03516 dest port:00053  |<1,01>        |
.....{snip}.....
.....{snip}.....
126|Apr 7 00  |From:192.168.1.1     To:192.168.1.255  |match          |forward
   |10:05:00  |UDP      src port:00520 dest port:00520  |<1,02>        |
127|Apr 7 00  |From:192.168.1.131   To:192.168.1.255  |match          |forward
   |10:05:17  |UDP      src port:00520 dest port:00520  |<1,02>        |
128|Apr 7 00  |From:192.168.1.1     To:192.168.1.255  |match          |forward
   |10:05:30  |UDP      src port:00520 dest port:00520  |<1,02>        |

End of Firewall Log

```

CHAPTER 29

Firmware Upgrade

29.1 Firmware Upgrade Overview

This chapter explains how to upgrade new firmware for your Zyxel Device. You can check and download new firmware online to upgrade your Zyxel Device's performance.

29.2 Firmware Upgrade

Click **Maintenance > Firmware Upgrade** to open the **following** screen. Click the **Upgrade** button to update to the latest available firmware. The **Upgrade** button is available only when the latest firmware update is available.

Do NOT turn off the Zyxel Device while firmware upload is in progress!

Figure 154 Maintenance > Firmware Upgrade

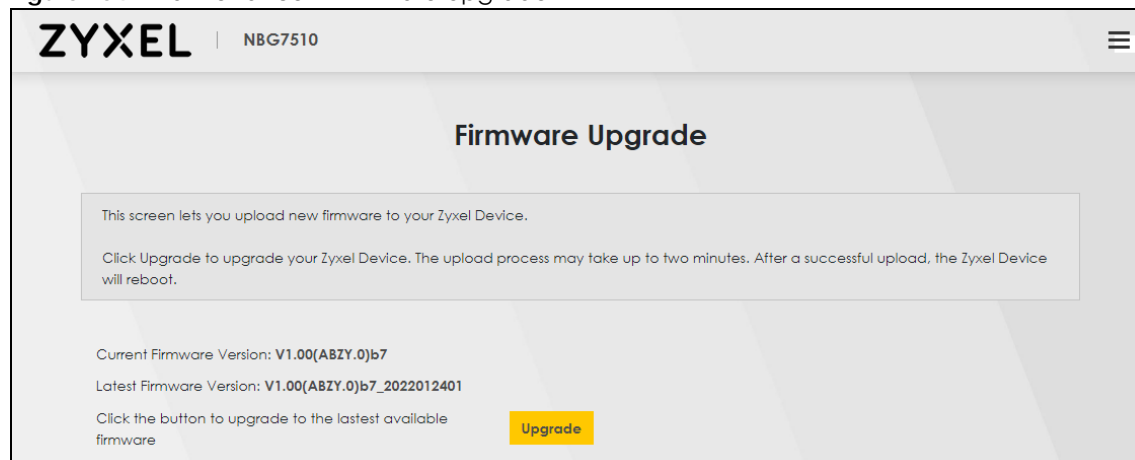

The following table describes the labels in this screen.

Table 104 Maintenance > Firmware Upgrade

LABEL	DESCRIPTION
Upgrade Firmware	
Current Firmware Version	This is the current firmware version.
Latest Firmware Version	This is the latest firmware version.

After you see the firmware updating screen, wait a few minutes before logging into the Zyxel Device again.

Figure 155 Firmware Uploading

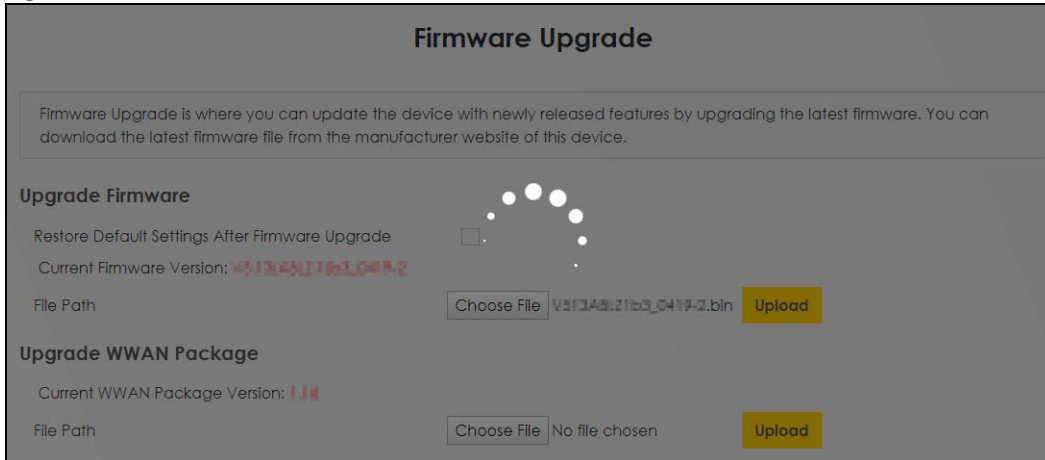

The Zyxel Device automatically restarts in this time causing a temporary network disconnect. In some operating systems, you may see the following icon on your desktop.

Figure 156 Network Temporarily Disconnected

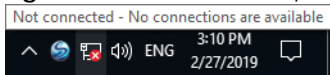

After 2 minutes, log in again and check your new firmware version in the **Connection Status** screen.

If the upload was not successful, an error screen will appear. Click **OK** to go back to the **Firmware Upgrade** screen.

Figure 157 Error Message

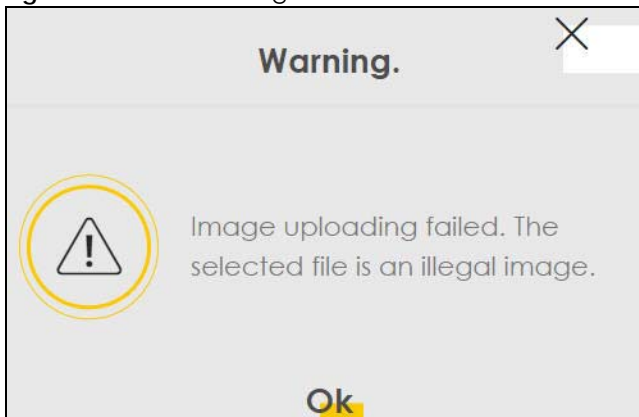

29.3 Module Upgrade

This screen lets you upload new firmware specific to the built-in LTE module in order to improve the LTE module's reliability and performance. The upload process uses HTTP (Hypertext Transfer Protocol) and may take more than 3 minutes. After a successful upload, the Zyxel Device will reboot.

Note: Use this screen to upload LTE module firmware only when you are instructed by Zyxel technical support team and provided with new LTE firmware release.

Note: Available for LTE5388-S905, LTE7480-S905, and LTE7485-S905 models only.

Click **Maintenance > Firmware Upgrade > Module Upgrade** to open the following screen.

Do NOT turn off the Zyxel Device while module firmware upload is in progress!

Figure 158 Maintenance > Firmware Upgrade > Module Upgrade

The following table describes the labels in this screen.

Table 105 Maintenance > Firmware Upgrade > Module Upgrade

LABEL	DESCRIPTION
Upgrade Cellular Module Firmware	
Current Module Version	This is the current module firmware version.
Choose file...	Enter the location of the file you want to upload in this field or click Choose File/Browse to find it.
Choose File/Browse	Click this to find the .bin file you want to upload. Remember that you must decompress compressed (.zip) files before you can upload them.
Upload	Click this to begin the upload process. This process may take more than 3 minutes.

CHAPTER 30

Backup/Restore

30.1 Backup/Restore Overview

Information related to factory default settings and backup configuration are shown in this screen. You can also use this to restore previous device configurations.

30.2 Backup/Restore

Click **Maintenance > Backup/Restore**. Information related to factory defaults, backup configuration, and restoring configuration appears in this screen, as shown next.

Figure 159 Maintenance > Backup/Restore

Backup/Restore

Back up and restore your Zyxel Device configurations. You can also reset your Zyxel Device settings back to the factory default.

Backup Configuration allows you to back up (save) the Zyxel Device's current configuration to a file on your computer. Once the Zyxel Device is configured and functioning properly, it is highly recommended that you back up your configuration file before making configuration changes. The backup configuration file will be useful in case you need to return to your previous settings.

Restore Configuration allows you to upload a new or previously saved configuration file from your computer to your Zyxel Device.

Backup Configuration

Click Backup to save the current configuration of your system to your computer.

Backup

Restore Configuration

To restore a previously saved configuration file to your system, browse to the location of the configuration file and click Upload.

File Path

Back to Factory Default Settings

Click Reset to clear all user-entered configuration information and return to factory default settings. After resetting, the

- Password is printed on a label on the bottom of the device, written after the text "Password".
- LAN IP address will be 192.168.1.1
- DHCP will be reset to default setting

Reset

Backup Configuration

Backup Configuration allows you to back up (save) the Zyxel Device's current configuration to a file on your computer. Once your Zyxel Device is configured and functioning properly, it is highly recommended that you back up your configuration file before making configuration changes. The backup configuration file will be useful in case you need to return to your previous settings.

Click **Backup** to save the Zyxel Device's current configuration to your computer.

Restore Configuration

Restore Configuration allows you to upload a new or previously saved configuration file from your computer to your Zyxel Device.

Table 106 Maintenance > Backup/Restore: Restore Configuration

LABEL	DESCRIPTION
File Path	Type in the location of the file you want to upload in this field or click Choose File / Browse to find it.
Choose File / Browse	Click this to find the file you want to upload. Remember that you must decompress compressed (.ZIP) files before you can upload them.
Upload	Click this to begin the upload process.
Reset	Click this to reset your Zyxel Device settings back to the factory default.

Do not turn off the Zyxel Device while configuration file upload is in progress.

After the Zyxel Device configuration has been restored successfully, the login screen appears. Login again to restart the Zyxel Device.

The Zyxel Device automatically restarts in this time causing a temporary network disconnect. In some operating systems, you may see the following icon on your desktop.

Figure 160 Network Temporarily Disconnected

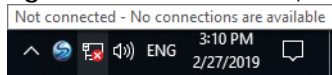

If you restore the default configuration, you may need to change the IP address of your computer to be in the same subnet as that of the default Zyxel Device IP address (192.168.1.1/192.168.123.1).

If the upload was not successful, an error screen will appear. Click **OK** to go back to the **Configuration** screen.

Figure 161 Configuration Upload Error

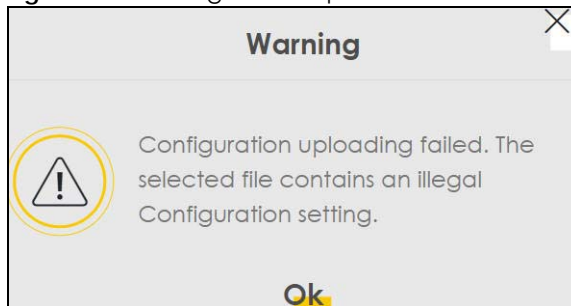

Reset to Factory Defaults

Click the **Reset** button to clear all user-entered configuration information and return the Zyxel Device to its factory defaults. The following warning screen appears.

Figure 162 Reset Warning Message



Figure 163 Reset In Progress

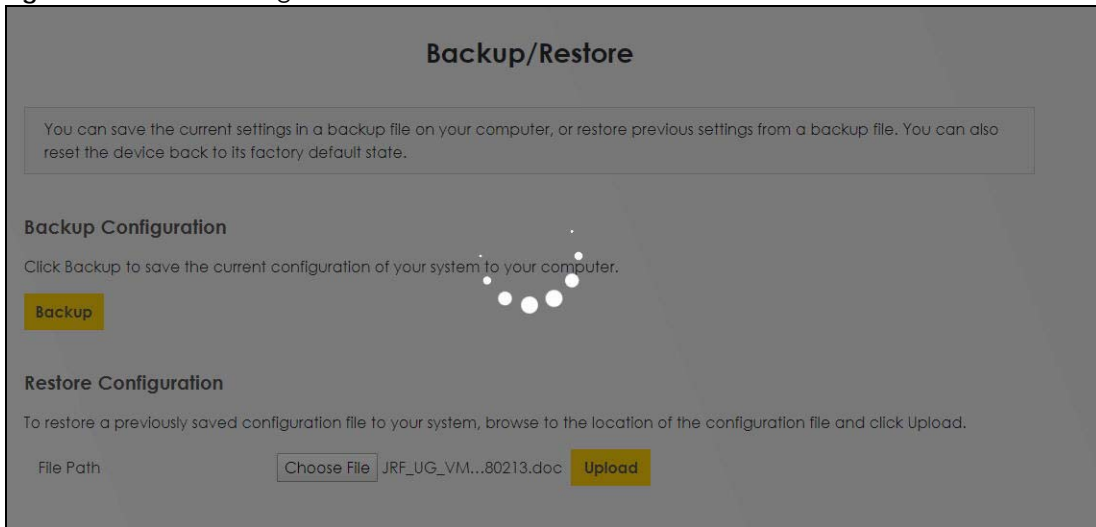

You can also press the **RESET** button on the panel to reset the factory defaults of your Zyxel Device.

30.3 Reboot

System **Reboot** allows you to reboot the Zyxel Device remotely without turning the power off. You may need to do this if the Zyxel Device hangs, for example. This does not affect the Zyxel Device's configuration.

Click **Maintenance > Reboot**. Click **Reboot** to have the Zyxel Device reboot.

Figure 164 Maintenance > Reboot

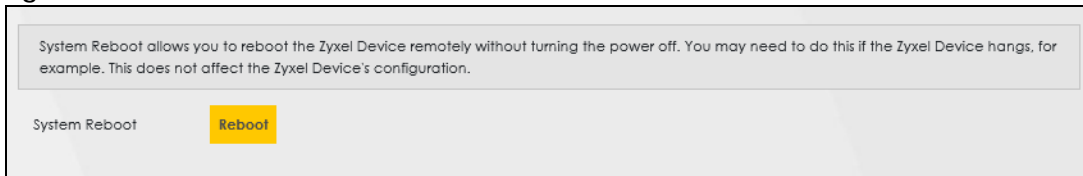

CHAPTER 31

Diagnostic

31.1 Diagnostic Overview

The **Diagnostic** screen displays information to help you identify problems with the Zyxel Device.

31.1.1 What You Can Do in this Chapter

- The **Diagnostic** screen lets you ping an IP address or trace the route packets take to a host ([Section 31.2 on page 251](#)).

31.2 Diagnostic

Use this screen to ping, traceroute, nslookup, or speed test for troubleshooting. Ping and traceroute are used to test whether a particular host is reachable. After entering an IP address and clicking one of the buttons to start a test, the results will be shown in the **Ping/Traceroute Test** area. Use nslookup to find the IP address for a host name and vice versa. Use speed test to determine the download and upload speed.

Click **Maintenance > Diagnostic** to open the following screen.

Figure 165 Maintenance > Diagnostic

Diagnostic

You can use different diagnostic methods to test a connection and see its detailed information. The **Diagnostic** screens display information to help you identify problems with the Zyxel Device.

Perform ping, traceroute, or nslookup for troubleshooting. Ping and traceroute are used to test whether a particular host is reachable. After entering an IP address and clicking one of the buttons to start a test, the results will be shown in the Ping/Traceroute Test area. Use nslookup to find the IP address for a host name and vice versa.

Ping/TraceRoute Test

TCP/IP

Address

The following table describes the fields in this screen.

Table 107 Maintenance > Diagnostic

LABEL	DESCRIPTION
Ping/TraceRoute Test (Diagnostic Test)	The result of tests is shown here in the info area.
TCP/IP	
Address	Type the IP address of a computer that you want to perform ping, traceroute, or nslookup in order to test a connection.
Ping	Click this button to perform a ping test on the IPv4 address or host name in order to test a connection. The ping statistics will show in the info area.
Ping 6	Click this button to perform a ping test on the IPv6 address or host name in order to test a connection. The ping statistics will show in the info area.
Trace Route	Click this button to perform the IPv4 trace route function. This determines the path a packet takes to the specified host.
Trace Route 6	Click this button to perform the IPv6 trace route function. This determines the path a packet takes to the specified host.
Nslookup	Click this button to perform a DNS lookup on the IP address or host name.

PART III

Troubleshooting and Appendices

Appendices contain general information. Some information may not apply to your Zyxel Device.

CHAPTER 32

Troubleshooting

32.1 Troubleshooting Overview

This chapter offers some suggestions to solve problems you might encounter. The potential problems are divided into the following categories.

- [Power and Hardware Problems](#)
- [Device Access Problems](#)
- [Internet Problems](#)
- [WiFi Problems](#)
- [UPnP Problems](#)

32.2 Power and Hardware Problems

[The Zyxel Device does not turn on.](#)

- 1 Make sure you are using the power adapter included with the Zyxel Device.
- 2 Make sure the power adapter is connected to the Zyxel Device and plugged in to an appropriate power source. Make sure the power source is turned on.
- 3 Disconnect and re-connect the power adapter to the Zyxel Device.
- 4 Make sure you have pressed the **POWER** button to turn on the Zyxel Device.
- 5 If the problem continues, contact the vendor.

[The LED does not behave as expected.](#)

- 1 Make sure you understand the normal behavior of the LED.
- 2 Check the hardware connections.
- 3 Inspect your cables for damage. Contact the vendor to replace any damaged cables.
- 4 Turn the Zyxel Device off and on.

- 5 If the problem continues, contact the vendor.

32.3 Device Access Problems

[I do not know the IP address of the Zyxel Device.](#)

- 1 The default IP address is 192.168.123.1
 - 2 If you changed the IP address, you might be able to find the IP address of the Zyxel Device by looking up the IP address of your computer's default gateway. To do this in Microsoft Windows, click **Start > Run**, enter **cmd**, and then enter **ipconfig**. The IP address of the **Default Gateway** might be the IP address of the Zyxel Device, depending on your network environment.
 - 3 If this does not work, reset the Zyxel Device to its factory defaults.
-

[I forgot the admin password.](#)

- 1 See the Zyxel Device label or this document's cover page for the default admin password.
 - 2 If you changed the password from default and cannot remember the new one, you have to reset the Zyxel Device to its factory default settings.
-

[I cannot access the Web Configurator login screen.](#)

- 1 Make sure you are using the correct IP address.
 - The default IP address is 192.168.123.1.
 - If you changed the IP address ([Section 10.2 on page 146](#)), use the new IP address.
 - If you changed the IP address and have forgotten the new address, see the troubleshooting suggestions for [I do not know the IP address of the Zyxel Device](#).
 - 2 Check the hardware connections, and make sure the LEDs are behaving as expected.
 - 3 Make sure your Internet browser does not block pop-up windows and has JavaScript and Java enabled.
 - 4 If it is possible to log in from another interface, check the service control settings for HTTP and HTTPS (**Maintenance > Remote Management**).
 - 5 Reset the Zyxel Device to its factory default, and try to access the Zyxel Device with the default IP address.
-

- 6 If the problem continues, contact the network administrator or vendor, or try one of the advanced suggestions.

Advanced Suggestions

- Make sure you have logged out of any earlier management sessions using the same user account even if they were through a different interface or using a different browser.
- Try to access the Zyxel Device using another service, such as Telnet. If you can access the Zyxel Device, check the remote management settings and firewall rules to find out why the Zyxel Device does not respond to HTTP.

I cannot log into the Zyxel Device.

- 1 Make sure you have entered the user name and password correctly. The default user name is **admin**. These both user name and password are case-sensitive, so make sure [Caps Lock] is not on.
- 2 You cannot log in to the Web Configurator while someone is using Telnet to access the Zyxel Device. Log out of the Zyxel Device in the other session, or ask the person who is logged in to log out.
- 3 Turn the Zyxel Device off and on.
- 4 If this does not work, you have to reset the Zyxel Device to its factory default.

I cannot log into the Zyxel Device using DDNS.

If you connect your Zyxel Device to the Internet and it uses a dynamic WAN IP address, it is inconvenient for you to manage the device from the Internet. The Zyxel Device's WAN IP address changes dynamically. Dynamic DNS (DDNS) allows you to access the Zyxel Device using a domain name.

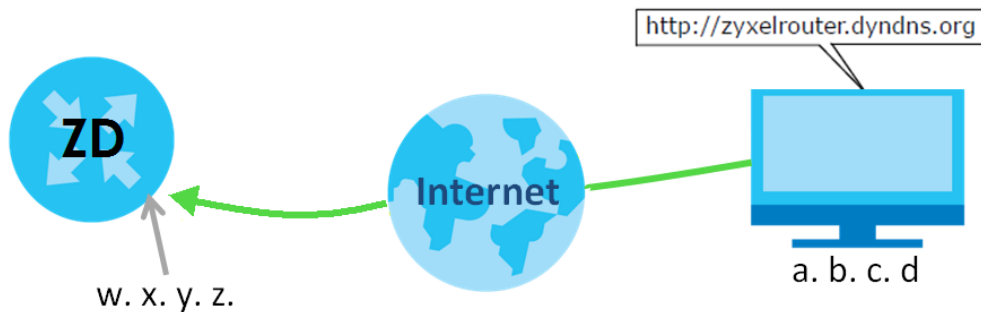

To use this feature, you have to apply for DDNS service at www.dyndns.org.

Note: If you have a private WAN IP address, then you cannot use DDNS.

Here are the three steps to use a domain name to log in the Web Configurator:

Step 1 Register for a DDNS Account on www.dyndns.org

- 1 Open a browser and type **http://www.dyndns.org**.
- 2 Apply for a user account. This tutorial uses **UserName1** and **12345** as the username and password.
- 3 Log into www.dyndns.org using your account.
- 4 Add a new DDNS host name. This tutorial uses the following settings as an example.
 - Hostname: **zyxelrouter.dyndns.org**
 - Service Type: **Host with IP address**
 - IP Address: Enter the WAN IP address that your Zyxel Device is currently using. You can find the IP address on the Zyxel Device's Web Configurator **Status** page.

Then you will need to configure the same account and host name on the Zyxel Device later.

Step 2 Configure DDNS on Your Zyxel Device

Configure the following settings in the **Network Setting > DNS > Dynamic DNS** screen.

- Select **Enable Dynamic DNS**.
- Select **www.DynDNS.com** as the service provider.
- Type **zyxelrouter.dyndns.org** in the **Host Name** field.
- Enter the user name (**UserName1**) and password (**12345**). Click **Apply**.

Step 3 Test the DDNS Setting

Now you should be able to access the Zyxel Device from the Internet. To test this:

- 1 Open a web browser on the computer (using the IP address **a.b.c.d**) that is connected to the Internet.
- 2 Type **http://zyxelrouter.dyndns.org** and press [Enter].
- 3 The Zyxel Device's login page should appear. You can then log into the Zyxel Device and manage it.

[I cannot connect to the Zyxel Device using FTP, Telnet, SSH, or Ping.](#)

- 1 See the Remote Management section for details on allowing web services (such as HTTP, HTTPS, FTP, Telnet, SSH and Ping) to access the Zyxel Device.
- 2 Check the server **Port** number field for the web service in the **Maintenance > Remote Management** screen. You must use the same port number in order to use that web service for remote management.
- 3 Try the troubleshooting suggestions for [I cannot access the Web Configurator login screen](#). Ignore the suggestions about your browser.

32.4 Internet Problems

I cannot access the Internet.

- 1 Check the hardware connections and make sure the LEDs are behaving as expected. See the **Quick Start Guide**.
 - 2 Make sure you entered your ISP account information correctly on the **Network Setting > Broadband** screen. Fields on this screen are case-sensitive, so make sure [Caps Lock] is not on.
 - 3 If you are trying to access the Internet wirelessly, make sure that you enabled the WiFi in the Zyxel Device and your WiFi client and that the WiFi settings in the WiFi client are the same as the settings in the Zyxel Device.
 - 4 Disconnect all the cables from your device and reconnect them.
 - 5 If the problem continues, contact your ISP.
-

I cannot connect to the Internet using an Ethernet connection.

- 1 Make sure you have the Ethernet WAN port connected to a Modem or Router.
 - 2 Make sure you configured a proper Ethernet WAN interface (**Network Setting > Broadband** screen) with the Internet account information provided by your ISP and that it is enabled.
 - 3 Check that the WAN interface you are connected to is in the same interface group as the Ethernet connection (**Network Setting > Interface Group**).
 - 4 If you set up a WAN connection using bridging service, make sure you turn off the DHCP feature in the **Network Setting > Home Networking > LAN Setup** screen to have the clients get WAN IP addresses directly from your ISP's DHCP server.
-

The Internet connection is slow or intermittent.

- 1 There might be a lot of traffic on the network. If the Zyxel Device is sending or receiving a lot of information, try closing some programs that use the Internet, especially peer-to-peer applications.
 - 2 Check the signal strength. Look at the LEDs, and check the LED section for more information. If the signal strength is low, try moving the Zyxel Device closer to the ISP's base station if possible, and look around to see if there are any devices that might be interfering with the wireless network (for example, microwaves, other wireless networks, and so on).
 - 3 Turn the Zyxel Device off and on.
-

- 4 If the problem continues, contact the network administrator or vendor, or try the advanced suggestions in [I cannot access the Web Configurator login screen](#).

32.5 WiFi Problems

[I cannot connect to the Zyxel Device WiFi.](#)

- 1 Check the WiFi LED status to make sure the Zyxel Device WiFi is on.
- 2 Make sure your WiFi client is within transmission range of the Zyxel Device.
- 3 Make sure you entered the correct SSID and password. See the Zyxel Device back label for the default SSID and password.
- 4 Make sure your WiFi client is using the same WiFi security type (WPA2-PSK, WPA3-SAE, or none) as the Zyxel Device.
- 5 Make sure the WiFi adapter on your WiFi client is working properly. Right-click your computer's network adapter then select **Properties** to check your network adapter status.
- 6 Make sure the WiFi adapter on your WiFi client is IEEE 802.11-compatible and supports the same WiFi standard as the Zyxel Device radio.

[The WiFi connection is slow and intermittent.](#)

The following factors may cause interference:

- Obstacles: walls, ceilings, furniture, and so on.
- Building Materials: metal doors, aluminum studs.
- Electrical devices: microwaves, monitors, electric motors, cordless phones, and other wireless devices.

To optimize the speed and quality of your WiFi connection, you can:

- Move your wireless device closer to the AP if the signal strength is low.
- Reduce wireless interference that may be caused by other WiFi networks or surrounding wireless electronics such as cordless phones.
- Place the AP where there are minimum obstacles (such as walls and ceilings) between the AP and the WiFi client.
- Reduce the number of WiFi clients connecting to the same AP simultaneously, or add additional APs if necessary.
- Try closing some programs that use the Internet, especially peer-to-peer applications. If the WiFi client is sending or receiving a lot of information, it may have too many programs open that use the Internet.

- Place the Zyxel Device where there are minimum obstacles (such as walls and ceilings) between the Zyxel Device and the WiFi client. Avoid placing the Zyxel Device inside any type of box that might block WiFi signals.

32.6 UPnP Problems

[My computer cannot detect UPnP settings from the Zyxel Device.](#)

- 1 Make sure that UPnP is enabled in your computer. For Windows 10, see [Section 10.9 on page 159](#).
- 2 On the Zyxel Device, make sure that UPnP is enabled on the **Network Settings > Home Networking > UPnP** screen. See [Section 10.4 on page 152](#) for details.
- 3 Disconnect the Ethernet cable from the Zyxel Device's Ethernet port or from your computer.
- 4 Reconnect the Ethernet cable.
- 5 Restart your computer.

32.7 Getting More Troubleshooting Help

Search for support information for your model at www.zyxel.com and community.zyxel.com for more troubleshooting suggestions.

APPENDIX A

Customer Support

In the event of problems that cannot be solved by using this manual, you should contact your vendor. If you cannot contact your vendor, then contact a Zyxel office for the region in which you bought the device.

For Zyxel Communications offices, see <https://service-provider.zyxel.com/global/en/contact-us> for the latest information.

For Zyxel Networks offices, see <https://www.zyxel.com/index.shtml> for the latest information.

Please have the following information ready when you contact an office.

Required Information

- Product model and serial number.
- Warranty Information.
- Date that you received your device.
- Brief description of the problem and the steps you took to solve it.

Corporate Headquarters (Worldwide)

Taiwan

- Zyxel Communications Corporation
- <https://www.zyxel.com>

Asia

China

- Zyxel Communications (Shanghai) Corp.
- Zyxel Communications (Beijing) Corp.
- Zyxel Communications (Tianjin) Corp.
- <https://www.zyxel.com/cn/zh/>

India

- Zyxel Technology India Pvt Ltd.
- <https://www.zyxel.com/in/en/>

Kazakhstan

- Zyxel Kazakhstan
- <https://www.zyxel.kz>

Korea

- Zyxel Korea Corp.
- <http://www.zyxel.kr>

Malaysia

- Zyxel Malaysia Sdn Bhd.
- <http://www.zyxel.com.my>

Pakistan

- Zyxel Pakistan (Pvt.) Ltd.
- <http://www.zyxel.com.pk>

Philippines

- Zyxel Philippines
- <http://www.zyxel.com.ph>

Singapore

- Zyxel Singapore Pte Ltd.
- <http://www.zyxel.com.sg>

Taiwan

- Zyxel Communications Corporation
- <https://www.zyxel.com/tw/zh/>

Thailand

- Zyxel Thailand Co., Ltd.
- <https://www.zyxel.com/th/th/>

Vietnam

- Zyxel Communications Corporation-Vietnam Office
- <https://www.zyxel.com/vn/vi>

Europe

Belarus

- Zyxel BY
- <https://www.zyxel.by>

Bulgaria

- Zyxel България
- <https://www.zyxel.com/bg/bg/>

Czech Republic

- Zyxel Communications Czech s.r.o
- <https://www.zyxel.com/cz/cs/>

Denmark

- Zyxel Communications A/S
- <https://www.zyxel.com/dk/da/>

Finland

- Zyxel Communications
- <https://www.zyxel.com/fi/fi/>

France

- Zyxel France
- <https://www.zyxel.fr>

Germany

- Zyxel Deutschland GmbH
- <https://www.zyxel.com/de/de/>

Hungary

- Zyxel Hungary & SEE
- <https://www.zyxel.com/hu/hu/>

Italy

- Zyxel Communications Italy
- <https://www.zyxel.com/it/it/>

Netherlands

- Zyxel Benelux
- <https://www.zyxel.com/nl/nl/>

Norway

- Zyxel Communications
- <https://www.zyxel.com/no/no/>

Poland

- Zyxel Communications Poland
- <https://www.zyxel.com/pl/pl/>

Romania

- Zyxel Romania

- <https://www.zyxel.com/ro/ro>

Russia

- Zyxel Russia
- <https://www.zyxel.com/ru/ru/>

Slovakia

- Zyxel Communications Czech s.r.o. organizacna zlozka
- <https://www.zyxel.com/sk/sk/>

Spain

- Zyxel Communications ES Ltd.
- <https://www.zyxel.com/es/es/>

Sweden

- Zyxel Communications
- <https://www.zyxel.com/se/sv/>

Switzerland

- Studerus AG
- <https://www.zyxel.ch/de>
- <https://www.zyxel.ch/fr>

Turkey

- Zyxel Turkey A.S.
- <https://www.zyxel.com/tr/tr/>

UK

- Zyxel Communications UK Ltd.
- <https://www.zyxel.com/uk/en/>

Ukraine

- Zyxel Ukraine
- <http://www.ua.zyxel.com>

South America

Argentina

- Zyxel Communications Corporation
- <https://www.zyxel.com/co/es/>

Brazil

- Zyxel Communications Brasil Ltda.
- <https://www.zyxel.com/br/pt/>

Colombia

- Zyxel Communications Corporation
- <https://www.zyxel.com/co/es/>

Ecuador

- Zyxel Communications Corporation
- <https://www.zyxel.com/co/es/>

South America

- Zyxel Communications Corporation
- <https://www.zyxel.com/co/es/>

Middle East

Israel

- Zyxel Communications Corporation
- <http://il.zyxel.com/>

North America

USA

- Zyxel Communications, Inc. – North America Headquarters
- <https://www.zyxel.com/us/en/>

APPENDIX B

IPv6

Overview

IPv6 (Internet Protocol version 6), is designed to enhance IP address size and features. The increase in IPv6 address size to 128 bits (from the 32-bit IPv4 address) allows up to 3.4×10^{38} IP addresses.

IPv6 Addressing

The 128-bit IPv6 address is written as eight 16-bit hexadecimal blocks separated by colons (:). This is an example IPv6 address `2001:0db8:1a2b:0015:0000:0000:1a2f:0000`.

IPv6 addresses can be abbreviated in two ways:

- Leading zeros in a block can be omitted. So `2001:0db8:1a2b:0015:0000:0000:1a2f:0000` can be written as `2001:db8:1a2b:15:0:0:1a2f:0`.
- Any number of consecutive blocks of zeros can be replaced by a double colon. A double colon can only appear once in an IPv6 address. So `2001:0db8:0000:0000:1a2f:0000:0000:0015` can be written as `2001:0db8::1a2f:0000:0000:0015`, `2001:0db8:0000:0000:1a2f::0015`, `2001:db8::1a2f:0:0:15` or `2001:db8:0:0:1a2f::15`.

Prefix and Prefix Length

Similar to an IPv4 subnet mask, IPv6 uses an address prefix to represent the network address. An IPv6 prefix length specifies how many most significant bits (start from the left) in the address compose the network address. The prefix length is written as "/x" where x is a number. For example,

`2001:db8:1a2b:15::1a2f:0/32`

means that the first 32 bits (`2001:db8`) is the subnet prefix.

Link-local Address

A link-local address uniquely identifies a device on the local network (the LAN). It is similar to a "private IP address" in IPv4. You can have the same link-local address on multiple interfaces on a device. A link-local unicast address has a predefined prefix of `fe80::/10`. The link-local unicast address format is as follows.

Table 108 Link-local Unicast Address Format

1111 1110 10	0	Interface ID
10 bits	54 bits	64 bits

Global Address

A global address uniquely identifies a device on the Internet. It is similar to a "public IP address" in IPv4. A global unicast address starts with a 2 or 3.

Unspecified Address

An unspecified address (0:0:0:0:0:0 or ::) is used as the source address when a device does not have its own address. It is similar to "0.0.0.0" in IPv4.

Loopback Address

A loopback address (0:0:0:0:0:1 or ::1) allows a host to send packets to itself. It is similar to "127.0.0.1" in IPv4.

Multicast Address

In IPv6, multicast addresses provide the same functionality as IPv4 broadcast addresses. Broadcasting is not supported in IPv6. A multicast address allows a host to send packets to all hosts in a multicast group.

Multicast scope allows you to determine the size of the multicast group. A multicast address has a predefined prefix of ff00::/8. The following table describes some of the predefined multicast addresses.

Table 109 Predefined Multicast Address

MULTICAST ADDRESS	DESCRIPTION
FF01:0:0:0:0:0:1	All hosts on a local node.
FF01:0:0:0:0:0:2	All routers on a local node.
FF02:0:0:0:0:0:1	All hosts on a local connected link.
FF02:0:0:0:0:0:2	All routers on a local connected link.
FF05:0:0:0:0:0:2	All routers on a local site.
FF05:0:0:0:0:0:1:3	All DHCP servers on a local site.

The following table describes the multicast addresses which are reserved and cannot be assigned to a multicast group.

Table 110 Reserved Multicast Address

MULTICAST ADDRESS
FF00:0:0:0:0:0:0:0
FF01:0:0:0:0:0:0:0
FF02:0:0:0:0:0:0:0
FF03:0:0:0:0:0:0:0
FF04:0:0:0:0:0:0:0
FF05:0:0:0:0:0:0:0
FF06:0:0:0:0:0:0:0
FF07:0:0:0:0:0:0:0
FF08:0:0:0:0:0:0:0
FF09:0:0:0:0:0:0:0
FF0A:0:0:0:0:0:0:0
FF0B:0:0:0:0:0:0:0
FF0C:0:0:0:0:0:0:0
FF0D:0:0:0:0:0:0:0
FF0E:0:0:0:0:0:0:0
FF0F:0:0:0:0:0:0:0

Subnet Masking

Both an IPv6 address and IPv6 subnet mask compose of 128-bit binary digits, which are divided into eight 16-bit blocks and written in hexadecimal notation. Hexadecimal uses four bits for each character (1 – 10, A – F). Each block's 16 bits are then represented by four hexadecimal characters. For example, FFFF:FFFF:FFFF:FFFF:FC00:0000:0000:0000.

Interface ID

In IPv6, an interface ID is a 64-bit identifier. It identifies a physical interface (for example, an Ethernet port) or a virtual interface (for example, the management IP address for a VLAN). One interface should have a unique interface ID.

EUI-64

The EUI-64 (Extended Unique Identifier) defined by the IEEE (Institute of Electrical and Electronics Engineers) is an interface ID format designed to adapt with IPv6. It is derived from the 48-bit (6-byte) Ethernet MAC address as shown next. EUI-64 inserts the hex digits fffe between the third and fourth bytes of the MAC address and complements the seventh bit of the first byte of the MAC address. See the following example.

Table 111

MAC	00	: 13	: 49	: 12	: 34	: 56
-----	----	------	------	------	------	------

Table 112

EUI-64	02	: 13	: 49	: FF	: FE	: 12	: 34	: 56
--------	----	------	------	------	------	------	------	------

Identity Association

An Identity Association (IA) is a collection of addresses assigned to a DHCP client, through which the server and client can manage a set of related IP addresses. Each IA must be associated with exactly one interface. The DHCP client uses the IA assigned to an interface to obtain configuration from a DHCP server for that interface. Each IA consists of a unique IAID and associated IP information.

The IA type is the type of address in the IA. Each IA holds one type of address. IA_NA means an identity association for non-temporary addresses and IA_TA is an identity association for temporary addresses. An IA_NA option contains the T1 and T2 fields, but an IA_TA option does not. The DHCPv6 server uses T1 and T2 to control the time at which the client contacts with the server to extend the lifetimes on any addresses in the IA_NA before the lifetimes expire. After T1, the client sends the server (S1) (from which the addresses in the IA_NA were obtained) a Renew message. If the time T2 is reached and the server does not respond, the client sends a Rebind message to any available server (S2). For an IA_TA, the client may send a Renew or Rebind message at the client's discretion.

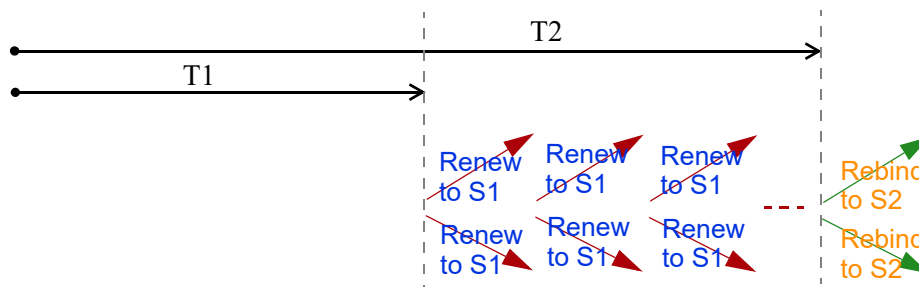

DHCP Relay Agent

A DHCP relay agent is on the same network as the DHCP clients and helps forward messages between the DHCP server and clients. When a client cannot use its link-local address and a well-known multicast address to locate a DHCP server on its network, it then needs a DHCP relay agent to send a message to a DHCP server that is not attached to the same network.

The DHCP relay agent can add the remote identification (remote-ID) option and the interface-ID option to the Relay-Forward DHCPv6 messages. The remote-ID option carries a user-defined string, such as the system name. The interface-ID option provides slot number, port information and the VLAN ID to the DHCPv6 server. The remote-ID option (if any) is stripped from the Relay-Reply messages before the relay agent sends the packets to the clients. The DHCP server copies the interface-ID option from the Relay-Forward message into the Relay-Reply message and sends it to the relay agent. The interface-ID should not change even after the relay agent restarts.

Prefix Delegation

Prefix delegation enables an IPv6 router to use the IPv6 prefix (network address) received from the ISP (or a connected uplink router) for its LAN. The Zyxel Device uses the received IPv6 prefix (for example, 2001:db2::/48) to generate its LAN IP address. Through sending Router Advertisements (RAs) regularly by multicast, the Zyxel Device passes the IPv6 prefix information to its LAN hosts. The hosts then can use the prefix to generate their IPv6 addresses.

ICMPv6

Internet Control Message Protocol for IPv6 (ICMPv6 or ICMP for IPv6) is defined in RFC 4443. ICMPv6 has a preceding Next Header value of 58, which is different from the value used to identify ICMP for IPv4. ICMPv6 is an integral part of IPv6. IPv6 nodes use ICMPv6 to report errors encountered in packet processing and perform other diagnostic functions, such as "ping".

Neighbor Discovery Protocol (NDP)

The Neighbor Discovery Protocol (NDP) is a protocol used to discover other IPv6 devices and track neighbor's reachability in a network. An IPv6 device uses the following ICMPv6 messages types:

- Neighbor solicitation: A request from a host to determine a neighbor's link-layer address (MAC address) and detect if the neighbor is still reachable. A neighbor being "reachable" means it responds to a neighbor solicitation message (from the host) with a neighbor advertisement message.
- Neighbor advertisement: A response from a node to announce its link-layer address.
- Router solicitation: A request from a host to locate a router that can act as the default router and forward packets.
- Router advertisement: A response to a router solicitation or a periodical multicast advertisement from a router to advertise its presence and other parameters.

IPv6 Cache

An IPv6 host is required to have a neighbor cache, destination cache, prefix list and default router list. The Zyxel Device maintains and updates its IPv6 caches constantly using the information from response messages. In IPv6, the Zyxel Device configures a link-local address automatically, and then sends a neighbor solicitation message to check if the address is unique. If there is an address to be resolved or verified, the Zyxel Device also sends out a neighbor solicitation message. When the Zyxel Device

receives a neighbor advertisement in response, it stores the neighbor's link-layer address in the neighbor cache. When the Zyxel Device uses a router solicitation message to query for a router and receives a router advertisement message, it adds the router's information to the neighbor cache, prefix list and destination cache. The Zyxel Device creates an entry in the default router list cache if the router can be used as a default router.

When the Zyxel Device needs to send a packet, it first consults the destination cache to determine the next hop. If there is no matching entry in the destination cache, the Zyxel Device uses the prefix list to determine whether the destination address is on-link and can be reached directly without passing through a router. If the address is un-link, the address is considered as the next hop. Otherwise, the Zyxel Device determines the next-hop from the default router list or routing table. Once the next hop IP address is known, the Zyxel Device looks into the neighbor cache to get the link-layer address and sends the packet when the neighbor is reachable. If the Zyxel Device cannot find an entry in the neighbor cache or the state for the neighbor is not reachable, it starts the address resolution process. This helps reduce the number of IPv6 solicitation and advertisement messages.

Multicast Listener Discovery

The Multicast Listener Discovery (MLD) protocol (defined in RFC 2710) is derived from IPv4's Internet Group Management Protocol version 2 (IGMPv2). MLD uses ICMPv6 message types, rather than IGMP message types. MLDv1 is equivalent to IGMPv2 and MLDv2 is equivalent to IGMPv3.

MLD allows an IPv6 switch or router to discover the presence of MLD listeners who wish to receive multicast packets and the IP addresses of multicast groups the hosts want to join on its network.

MLD snooping and MLD proxy are analogous to IGMP snooping and IGMP proxy in IPv4.

MLD filtering controls which multicast groups a port can join.

MLD Messages

A multicast router or switch periodically sends general queries to MLD hosts to update the multicast forwarding table. When an MLD host wants to join a multicast group, it sends an MLD Report message for that address.

An MLD Done message is equivalent to an IGMP Leave message. When an MLD host wants to leave a multicast group, it can send a Done message to the router or switch. The router or switch then sends a group-specific query to the port on which the Done message is received to determine if other devices connected to this port should remain in the group.

Example – Enabling IPv6 on Windows 10

Windows 10 supports IPv6 by default. DHCPv6 is also enabled when you enable IPv6 on a Windows 10 computer.

To enable IPv6 in Windows 10:

- 1 Click the start icon, **Settings** and then **Network & Internet**.
- 2 Select the **Internet Protocol Version 6 (TCP/IPv6)** checkbox to enable it.
- 3 Click **OK** to save the change.

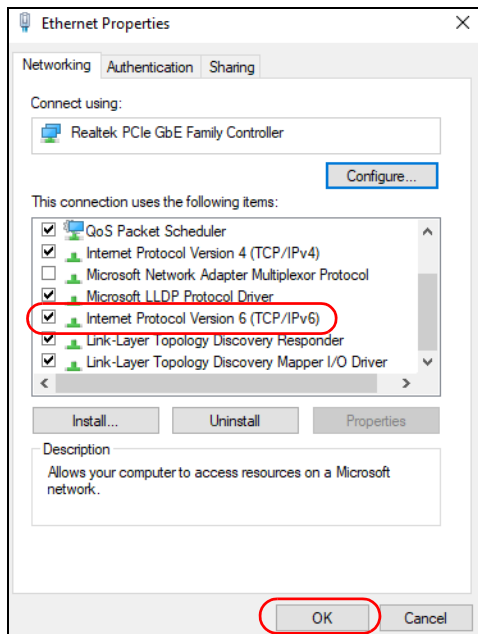

- 4 Click the Search icon () and then type "cmd" in the search box..
- 5 Use the `ipconfig` command to check your dynamic IPv6 address. This example shows a global address (2001:b021:2d::1000) obtained from a DHCP server.

```

C:\>ipconfig

Windows IP Configuration

Ethernet adapter Local Area Connection:

    Connection-specific DNS Suffix  . : 
    IPv6 Address. . . . . : 2001:b021:2d::1000
    Link-local IPv6 Address . . . . . : fe80::25d8:dcab:c80a:5189%11
    IPv4 Address. . . . . : 172.16.100.61
    Subnet Mask . . . . . : 255.255.255.0
    Default Gateway . . . . . : fe80::213:49ff:f

```

APPENDIX C

Services

The following table lists some commonly-used services and their associated protocols and port numbers.

- **Name:** This is a short, descriptive name for the service. You can use this one or create a different one, if you like.
- **Protocol:** This is the type of IP protocol used by the service. If this is **TCP/UDP**, then the service uses the same port number with TCP and UDP. If this is **USER-DEFINED**, the **Port(s)** is the IP protocol number, not the port number.
- **Port(s):** This value depends on the **Protocol**.
 - If the **Protocol** is **TCP**, **UDP**, or **TCP/UDP**, this is the IP port number.
 - If the **Protocol** is **USER**, this is the IP protocol number.
- **Description:** This is a brief explanation of the applications that use this service or the situations in which this service is used.

Table 113 Examples of Services

NAME	PROTOCOL	PORT(S)	DESCRIPTION
AH (IPSEC_TUNNEL)	User-Defined	51	The IPSEC AH (Authentication Header) tunneling protocol uses this service.
AIM	TCP	5190	AOL's Internet Messenger service.
AUTH	TCP	113	Authentication protocol used by some servers.
BGP	TCP	179	Border Gateway Protocol.
BOOTP_CLIENT	UDP	68	DHCP Client.
BOOTP_SERVER	UDP	67	DHCP Server.
CU-SEEME	TCP/UDP TCP/UDP	7648 24032	A popular videoconferencing solution from White Pines Software.
DNS	TCP/UDP	53	Domain Name Server, a service that matches web names (for instance www.zyxel.com) to IP numbers.
ESP (IPSEC_TUNNEL)	User-Defined	50	The IPSEC ESP (Encapsulation Security Protocol) tunneling protocol uses this service.
FINGER	TCP	79	Finger is a UNIX or Internet related command that can be used to find out if a user is logged on.
FTP	TCP TCP	20 21	File Transfer Protocol, a program to enable fast transfer of files, including large files that may not be possible by email.
H.323	TCP	1720	NetMeeting uses this protocol.
HTTP	TCP	80	Hyper Text Transfer Protocol - a client/server protocol for the world wide web.
HTTPS	TCP	443	HTTPS is a secured http session often used in e-commerce.
ICMP	User-Defined	1	Internet Control Message Protocol is often used for diagnostic purposes.
ICQ	UDP	4000	This is a popular Internet chat program.
IGMP (MULTICAST)	User-Defined	2	Internet Group Multicast Protocol is used when sending packets to a specific group of hosts.
IKE	UDP	500	The Internet Key Exchange algorithm is used for key distribution and management.
IMAP4	TCP	143	The Internet Message Access Protocol is used for email.
IMAP4S	TCP	993	This is a more secure version of IMAP4 that runs over SSL.
IRC	TCP/UDP	6667	This is another popular Internet chat program.
MSN Messenger	TCP	1863	Microsoft Networks' messenger service uses this protocol.
NetBIOS	TCP/UDP TCP/UDP TCP/UDP TCP/UDP	137 138 139 445	The Network Basic Input/Output System is used for communication between computers in a LAN.
NEW-ICQ	TCP	5190	An Internet chat program.
NEWS	TCP	144	A protocol for news groups.

Table 113 Examples of Services (continued)

NAME	PROTOCOL	PORT(S)	DESCRIPTION
NFS	UDP	2049	Network File System - NFS is a client/server distributed file service that provides transparent file sharing for network environments.
NNTP	TCP	119	Network News Transport Protocol is the delivery mechanism for the USENET newsgroup service.
PING	User-Defined	1	Packet Internet Groper is a protocol that sends out ICMP echo requests to test whether or not a remote host is reachable.
POP3	TCP	110	Post Office Protocol version 3 lets a client computer get email from a POP3 server through a temporary connection (TCP/IP or other).
POP3S	TCP	995	This is a more secure version of POP3 that runs over SSL.
PPTP	TCP	1723	Point-to-Point Tunneling Protocol enables secure transfer of data over public networks. This is the control channel.
PPTP_TUNNEL (GRE)	User-Defined	47	PPTP (Point-to-Point Tunneling Protocol) enables secure transfer of data over public networks. This is the data channel.
RCMD	TCP	512	Remote Command Service.
REAL_AUDIO	TCP	7070	A streaming audio service that enables real time sound over the web.
REXEC	TCP	514	Remote Execution Daemon.
RLOGIN	TCP	513	Remote Login.
ROADRUNNER	TCP/UDP	1026	This is an ISP that provides services mainly for cable modems.
RTELNET	TCP	107	Remote Telnet.
RTSP	TCP/UDP	554	The Real Time Streaming (media control) Protocol (RTSP) is a remote control for multimedia on the Internet.
SFTP	TCP	115	The Simple File Transfer Protocol is an old way of transferring files between computers.
SMTP	TCP	25	Simple Mail Transfer Protocol is the message-exchange standard for the Internet. SMTP enables you to move messages from one email server to another.
SMTPS	TCP	465	This is a more secure version of SMTP that runs over SSL.
SNMP	TCP/UDP	161	Simple Network Management Program.
SNMP-TRAPS	TCP/UDP	162	Traps for use with the SNMP (RFC:1215).
SQL-NET	TCP	1521	Structured Query Language is an interface to access data on many different types of database systems, including mainframes, midrange systems, UNIX systems and network servers.
SSDP	UDP	1900	The Simple Service Discovery Protocol supports Universal Plug-and-Play (UPnP).
SSH	TCP/UDP	22	Secure Shell Remote Login Program.
STRM WORKS	UDP	1558	Stream Works Protocol.
SYSLOG	UDP	514	Syslog allows you to send system logs to a UNIX server.

Table 113 Examples of Services (continued)

NAME	PROTOCOL	PORT(S)	DESCRIPTION
TACACS	UDP	49	Login Host Protocol used for (Terminal Access Controller Access Control System).
TELNET	TCP	23	Telnet is the login and terminal emulation protocol common on the Internet and in UNIX environments. It operates over TCP/IP networks. Its primary function is to allow users to log into remote host systems.
VDOLIVE	TCP UDP	7000 user- defined	A videoconferencing solution. The UDP port number is specified in the application.

APPENDIX D

Legal Information

Copyright

Copyright © 2022 by Zyxel and/or its affiliates.

The contents of this publication may not be reproduced in any part or as a whole, transcribed, stored in a retrieval system, translated into any language, or transmitted in any form or by any means, electronic, mechanical, magnetic, optical, chemical, photocopying, manual, or otherwise, without the prior written permission of Zyxel and/or its affiliates..

Published by Zyxel and/or its affiliates. All rights reserved.

Disclaimer

Zyxel does not assume any liability arising out of the application or use of any products, or software described herein. Neither does it convey any license under its patent rights nor the patent rights of others. Zyxel further reserves the right to make changes in any products described herein without notice. This publication is subject to change without notice.

Regulatory Notice and Statement

UNITED STATES of AMERICA



The following information applies if you use the product within USA area.

FCC EMC Statement

- The device complies with Part 15 of FCC rules. Operation is subject to the following two conditions:
 - (1) This device may not cause harmful interference, and
 - (2) This device must accept any interference received, including interference that may cause undesired operation.
- Changes or modifications not expressly approved by the party responsible for compliance could void the user's authority to operate the device.
- This product has been tested and complies with the specifications for a Class B digital device, pursuant to Part 15 of the FCC Rules. These limits are designed to provide reasonable protection against harmful interference in a residential installation. This device generates, uses, and can radiate radio frequency energy and, if not installed and used according to the instructions, may cause harmful interference to radio communications. However, there is no guarantee that interference will not occur in a particular installation.
- If this device does cause harmful interference to radio or television reception, which is found by turning the device off and on, the user is encouraged to try to correct the interference by one or more of the following measures:
 - Reorient or relocate the receiving antenna
 - Increase the separation between the devices
 - Connect the equipment to an outlet other than the receiver's
 - Consult a dealer or an experienced radio/TV technician for assistance

The following information applies if you use the product with RF function within USA area.

FCC Radiation Exposure Statement

- This device complies with FCC RF radiation exposure limits set forth for an uncontrolled environment.
- This transmitter must be at least 20 cm from the user and must not be co-located or operating in conjunction with any other antenna or transmitter.
- Operation of this device is restricted to indoor use only, except for relevant user's manual mention that this device can be installed into the external environment.

EUROPEAN UNION and UNITED KINGDOM



The following information applies if you use the product within the European Union and United Kingdom.

Declaration of Conformity with Regard to EU Directive 2014/53/EU (Radio Equipment Directive, RED) and UK Regulation

- Compliance information for wireless products relevant to the EU, United Kingdom, and other Countries following the EU Directive 2014/53/EU (RED) and UK regulation. And this product may be used in all EU countries (and other countries following the EU Directive 2014/53/EU) and United Kingdom without any limitation except for the countries mentioned below table:
- In the majority of the EU, United Kingdom, and other European countries, the 5GHz bands have been made available for the use of wireless local area networks (LANs). Later in this document you will find an overview of countries in which additional restrictions or requirements or both are applicable. The requirements for any country may evolve. Zyxel recommends that you check with the local authorities for the latest status of their national regulations for the 5GHz wireless LANs.
- If this device for operation in the band 5150-5350 MHz, it is for indoor use only.
- This equipment should be installed and operated with minimum distance 20cm between the radiator and your body.
- The maximum RF power operating for each band as follows:
 - the band 2,400 to 2,483.5 MHz is 98.17 mW,
 - the bands 5,150 MHz to 5,350 MHz is 194.54 mW,
 - the 5,470 MHz to 5,725 MHz is 977.24 mW.

Български (Bulgarian)	С настоящото Zyxel декларира, че това оборудване е в съответствие със съществените изисквания и другите приложими разпоредбите на Директива 2014/53/ЕС. National Restrictions <ul style="list-style-type: none"> • The Belgian Institute for Postal Services and Telecommunications (BIPT) must be notified of any outdoor wireless link having a range exceeding 300 meters. Please check http://www.bipt.be for more details. • Draadloze verbindingen voor buitengebruik en met een reikwijdte van meer dan 300 meter dienen aangemeld te worden bij het Belgisch Instituut voor postdiensten en telecommunicatie (BIPT). Zie http://www.bipt.be voor meer gegevens. • Les liaisons sans fil pour une utilisation en extérieur d'une distance supérieure à 300 mètres doivent être notifiées à l'Institut Belge des services Postaux et des Télécommunications (IBPT). Visitez http://www.ibpt.be pour de plus amples détails.
Español (Spanish)	Por medio de la presente Zyxel declara que el equipo cumple con los requisitos esenciales y cualesquiera otras disposiciones aplicables o exigibles de la Directiva 2014/53/UE..
Čeština (Czech)	Zyxel tímto prohlašuje, že tento zařízení je ve shodě se základními požadavky a dalšími příslušnými ustanoveními směrnice 2014/53/EU.
Dansk (Danish)	Undertegnede Zyxel erklærer herved, at følgende udstyr overholder de væsentlige krav og øvrige relevante krav i direktiv 2014/53/EU. National Restrictions <ul style="list-style-type: none"> • In Denmark, the band 5150 - 5350 MHz is also allowed for outdoor usage. • I Danmark må frekvensbåndet 5150 - 5350 også anvendes udendørs.
Deutsch (German)	Hiermit erklärt Zyxel, dass sich das Gerät Ausstattung in Übereinstimmung mit den grundlegenden Anforderungen und den übrigen einschlägigen Bestimmungen der Richtlinie 2014/53/EU befindet.
Eesti keel (Estonian)	Käesolevaga kinnitab Zyxel seadme seadme vastavust direktiivi 2014/53/EU põhinõuetele ja nimetatud direktiivist tulenevatele teistele asjakohastele sätetele.
Ελληνικά (Greek)	ΜΕ ΤΗΝ ΠΑΡΟΥΣΑ Zyxel ΔΗΛΩΝΕΙ ΟΤΙ ΕΞΟΤΙΣΜΟΣ ΣΥΜΜΟΡΦΩΝΕΤΑΙ ΠΡΟΣ ΤΙΣ ΟΥΣΙΩΔΕΙΣ ΑΠΑΙΤΗΣΕΙΣ ΚΑΙ ΤΙΣ ΛΟΙΠΕΣ ΣΧΕΤΙΚΕΣ ΔΙΑΤΑΞΕΙΣ ΤΗΣ ΟΔΗΓΙΑΣ 2014/53/EU.
English	Hereby, Zyxel declares that this device is in compliance with the essential requirements and other relevant provisions of Directive 2014/53/EU.
Français (French)	Par la présente Zyxel déclare que l'appareil équipements est conforme aux exigences essentielles et aux autres dispositions pertinentes de la directive 2014/53/EU.
Hrvatski (Croatian)	Zyxel ovime izjavljuje da je radijska oprema tipa u skladu s Direktivom 2014/53/EU.
Íslenska (Icelandic)	Hér með lýsir, Zyxel því yfir að þessi búnaður er í samræmi við grunnkröfur og önnur viðeigandi ákvæði tilskipunar 2014/53/EU.
Italiano (Italian)	Con la presente Zyxel dichiara che questo attrezzatura è conforme ai requisiti essenziali ed alle altre disposizioni pertinenti stabilite dalla direttiva 2014/53/EU. National Restrictions <ul style="list-style-type: none"> • This product meets the National Radio Interface and the requirements specified in the National Frequency Allocation Table for Italy. Unless this wireless LAN product is operating within the boundaries of the owner's property, its use requires a "general authorization." Please check http://www.sviluppoeconomico.gov.it/ for more details. • Questo prodotto è conforme alla specifiche di Interfaccia Radio Nazionali e rispetta il Piano Nazionale di ripartizione delle frequenze in Italia. Se non viene installato all'interno del proprio fondo, l'utilizzo di prodotti Wireless LAN richiede una "Autorizzazione Generale". Consultare http://www.sviluppoeconomico.gov.it/ per maggiori dettagli.
Latviešu valoda (Latvian)	Ar šo Zyxel deklarē, ka iekārtas atbilst Direktīvas 2014/53/EU būtiskajām prasībām un citiem ar to saistītajiem noteikumiem. National Restrictions <ul style="list-style-type: none"> • The outdoor usage of the 2.4 GHz band requires an authorization from the Electronic Communications Office. Please check http://www.esd.lv for more details. • 2.4 GHz frekvenču joslas izmantošanai ārpus telpām nepieciešama atļauja no Elektronisko sakaru direkcijas. Vairāk informācijas: http://www.esd.lv.
Lietuvių kalba (Lithuanian)	Šiuo Zyxel deklaruoja, kad šis įranga atitinka esminius reikalavimus ir kitas 2014/53/EU Direktyvos nuostatas.

Magyar (Hungarian)	Alulírott, Zyxel nyilatkozom, hogy a berendezés megfelel a vonatkozó alapvető követelményeknek és az 2014/53/EU irányelv egyéb előírásainak.
Malti (Maltese)	Hawnhekk, Zyxel, jiddikjara li dan tagħmir jikkonforma mal-ftiġġiet essenzjali u ma provvedimenti oħrajn rilevanti li hemm fid-Dirrettiva 2014/53/EU.
Nederlands (Dutch)	Hierbij verklaart Zyxel dat het toestel uitrusting in overeenstemming is met de essentiële eisen en de andere relevante bepalingen van richtlijn 2014/53/EU.
Polski (Polish)	Niniejszym Zyxel oświadcza, że sprzęt jest zgodny z zasadniczymi wymogami oraz pozostałymi stosownymi postanowieniami Dyrektywy 2014/53/EU.
Português (Portuguese)	Zyxel declara que este equipamento está conforme com os requisitos essenciais e outras disposições da Directiva 2014/53/EU.
Română (Romanian)	Prin prezenta, Zyxel declară că acest echipament este în conformitate cu cerințele esențiale și alte prevederi relevante ale Directivei 2014/53/EU.
Slovenčina (Slovak)	Zyxel týmto vyhlasuje, že zariadenia spĺňa základné požiadavky a všetky príslušné ustanovenia Smernice 2014/53/EU.
Slovenščina (Slovene)	Zyxel izjavlja, da je ta oprema v skladu z bistvenimi zahtevami in ostalimi relevantnimi določili direktive 2014/53/EU.
Suomi (Finnish)	Zyxel vakuuttaa täten että laitteet tyyppinen laite on direktiivin 2014/53/EU oleellisten vaatimusten ja sitä koskevien direktiivin muiden ehtojen mukainen.
Svenska (Swedish)	Härmed intygar Zyxel att denna utrustning står i överensstämmelse med de väsentliga egenskapskrav och övriga relevanta bestämmelser som framgår av direktiv 2014/53/EU.
Norsk (Norwegian)	Erklærer herved Zyxel at dette utstyret er i samsvar med de grunnleggende kravene og andre relevante bestemmelser i direktiv 2014/53/EU.

Notes:

1. Although Norway, Switzerland and Liechtenstein are not EU member states, the EU Directive 2014/53/EU has also been implemented in those countries.

2. The regulatory limits for maximum output power are specified in EIRP. The EIRP level (in dBm) of a device can be calculated by adding the gain of the antenna used (specified in dBi) to the output power available at the connector (specified in dBm).

List of national codes

COUNTRY	ISO 3166 2 LETTER CODE	COUNTRY	ISO 3166 2 LETTER CODE
Austria	AT	Liechtenstein	LI
Belgium	BE	Lithuania	LT
Bulgaria	BG	Luxembourg	LU
Croatia	HR	Malta	MT
Cyprus	CY	Netherlands	NL
Czech Republic	CZ	Norway	NO
Denmark	DK	Poland	PL
Estonia	EE	Portugal	PT
Finland	FI	Romania	RO
France	FR	Serbia	RS
Germany	DE	Slovakia	SK
Greece	GR	Slovenia	SI
Hungary	HU	Spain	ES
Iceland	IS	Switzerland	CH
Ireland	IE	Sweden	SE
Italy	IT	Turkey	TR
Latvia	LV	United Kingdom	GB

Safety Warnings

- Do not use this product near water, for example, in a wet basement or near a swimming pool.
- Do not expose your device to dampness, dust or corrosive liquids.
- Do not store things on the device.
- Do not install, use, or service this device during a thunderstorm. There is a remote risk of electric shock from lightning.
- Connect ONLY suitable accessories to the device.

- Do not open the device or unit. Opening or removing covers can expose you to dangerous high voltage points or other risks. ONLY qualified service personnel should service or disassemble this device. Please contact your vendor for further information.
- Make sure to connect the cables to the correct ports.
- Place connecting cables carefully so that no one will step on them or stumble over them.
- Always disconnect all cables from this device before servicing or disassembling.
- Do not remove the plug and connect it to a power outlet by itself; always attach the plug to the power adaptor first before connecting it to a power outlet.
- Do not allow anything to rest on the power adaptor or cord and do NOT place the product where anyone can walk on the power adaptor or cord.
- Please use the provided or designated connection cables/power cables/ adaptors. Connect it to the right supply voltage (for example, 110V AC in North America or 230V AC in Europe). If the power adaptor or cord is damaged, it might cause electrocution. Remove it from the device and the power source, repairing the power adapter or cord is prohibited. Contact your local vendor to order a new one.
- Do not use the device outside, and make sure all the connections are indoors. There is a remote risk of electric shock from lightning.
- CAUTION: Risk of explosion if battery is replaced by an incorrect type, dispose of used batteries according to the instruction. Dispose them at the applicable collection point for the recycling of electrical and electronic devices. For detailed information about recycling of this product, please contact your local city office, your household waste disposal service or the store where you purchased the product.
- Do not obstruct the device ventilation slots, as insufficient airflow may harm your device. For example, do not place the device in an enclosed space such as a box or on a very soft surface such as a bed or sofa.
- The following warning statements apply, where the disconnect device is not incorporated in the device or where the plug on the power supply cord is intended to serve as the disconnect device,
 - For permanently connected devices, a readily accessible disconnect device shall be incorporated external to the device;
 - For pluggable devices, the socket-outlet shall be installed near the device and shall be easily accessible.

Important Safety Instructions

- Caution! The RJ-45 jacks are not used for telephone line connection.
- Caution! Do not use this product near water, for example a wet basement or near a swimming pool.
- Caution! Avoid using this product (other than a cordless type) during an electrical storm. There may be a remote risk of electric shock from lightning.
- Caution! Always disconnect all telephone lines from the wall outlet before servicing or disassembling this product.
- Attention: Les prises RJ-45 ne sont pas utilisés pour la connexion de la ligne téléphonique.
- Attention: Ne pas utiliser ce produit près de l'eau, par exemple un sous-sol humide ou près d'une piscine.
- Attention: Évitez d'utiliser ce produit (autre qu'un type sans fil) pendant un orage. Il peut y avoir un risque de choc électrique de la foudre.
- Attention: Toujours débrancher toutes les lignes téléphoniques de la prise murale avant de réparer ou de démonter ce produit.

Environment Statement

ErP (Energy-related Products)

Zyxel products put on the EU and United Kingdom market in compliance with the requirement of the European Parliament and the Council published Directive 2009/125/EC and UK regulation establishing a framework for the setting of ecodesign requirements for energy-related products (recast), so called

as "ErP Directive (Energy-related Products directive) as well as ecodesign requirement laid down in applicable implementing measures, power consumption has satisfied regulation requirements which are:

Network standby power consumption < 8W, and/or

Off mode power consumption < 0.5W, and/or

Standby mode power consumption < 0.5W.

(Wireless settings, please refer to "Wireless"the chapter about wireless settings for more detail.)

Disposal and Recycling Information

The symbol below means that according to local regulations your product and/or its battery shall be disposed of separately from domestic waste. If this product is end of life, take it to a recycling station designated by local authorities. At the time of disposal, the separate collection of your product and/or its battery will help save natural resources and ensure that the environment is sustainable development.

Die folgende Symbol bedeutet, dass Ihr Produkt und/oder seine Batterie gemäß den örtlichen Bestimmungen getrennt vom Hausmüll entsorgt werden muss. Wenden Sie sich an eine Recyclingstation, wenn dieses Produkt das Ende seiner Lebensdauer erreicht hat. Zum Zeitpunkt der Entsorgung wird die getrennte Sammlung von Produkt und/oder seiner Batterie dazu beitragen, natürliche Ressourcen zu sparen und die Umwelt und die menschliche Gesundheit zu schützen.

El símbolo de abajo indica que según las regulaciones locales, su producto y/o su batería deberán depositarse como basura separada de la doméstica. Cuando este producto alcance el final de su vida útil, llévelo a un punto limpio. Cuando llegue el momento de desechar el producto, la recogida por separado éste y/o su batería ayudará a salvar los recursos naturales y a proteger la salud humana y medioambiental.

Le symbole ci-dessous signifie que selon les réglementations locales votre produit et/ou sa batterie doivent être éliminés séparément des ordures ménagères. Lorsque ce produit atteint sa fin de vie, amenez-le à un centre de recyclage. Au moment de la mise au rebut, la collecte séparée de votre produit et/ou de sa batterie aidera à économiser les ressources naturelles et protéger l'environnement et la santé humaine.

Il simbolo sotto significa che secondo i regolamenti locali il vostro prodotto e/o batteria deve essere smaltito separatamente dai rifiuti domestici. Quando questo prodotto raggiunge la fine della vita di servizio portarlo a una stazione di riciclaggio. Al momento dello smaltimento, la raccolta separata del vostro prodotto e/o della sua batteria aiuta a risparmiare risorse naturali e a proteggere l'ambiente e la salute umana.

Symbolen innebär att enligt lokal lagstiftning ska produkten och/eller dess batteri kastas separat från hushållsavfallet. När den här produkten når slutet av sin livslängd ska du ta den till en återvinningsstation. Vid tiden för kasseringen bidrar du till en bättre miljö och mänsklig hälsa genom att göra dig av med den på ett återvinningsställe.



台灣



以下訊息僅適用於產品具有無線功能且銷售至台灣地區

- 取得審驗證明之低功率射頻器材，非經核准，公司、商號或使用者均不得擅自變更頻率、加大功率或變更原設計之特性及功能。
- 低功率射頻電機之使用不得影響飛航安全及干擾合法通信；經發現有干擾現象時，應立即停用，並改善至無干擾時方得繼續使用。
- 前述合法通信，指依電信管理法規定作業之無線電通信低功率射頻電機須忍受合法通信或工業、科學及醫療用電波輻射性電機設備之干擾。
- 使用無線產品時，應避免影響附近雷達系統之操作。高增益指向性天線只得應用於固定式點對點系統。

以下訊息僅適用於產品屬於專業安裝並銷售至台灣地區

- 本器材須經專業工程人員安裝及設定，始得設置使用，且不得直接販售給一般消費者。





安全警告 - 為了您的安全，請先閱讀以下警告及指示：

- 請勿將此產品接近水、火焰或放置在高溫的環境。
- 避免設備接觸：
 - 任何液體 - 切勿讓設備接觸水、雨水、高濕度、污水腐蝕性的液體或其他水份。
 - 灰塵及污物 - 切勿接觸灰塵、污物、沙土、食物或其他不適合的材料。
- 雷雨天氣時，不要安裝，使用或維修此設備。有遭受電擊的風險。
- 切勿重摔或撞擊設備，並勿使用不正確的電源變壓器。
- 若接上不正確的電源變壓器會有爆炸的風險。
- 請勿隨意更換產品內的電池。
- 如果更換不正確之電池型式，會有爆炸的風險，請依製造商說明書處理使用過之電池。
- 請將廢電池丟棄在適當的電器或電子設備回收處。
- 請勿將設備解體。
- 請勿阻礙設備的散熱孔，空氣對流不足將會造成設備損害。
- 請插在正確的電壓供給插座（如：北美 / 台灣電壓 110V AC，歐洲是 230V AC）。
- 假若電源變壓器或電源變壓器的纜線損壞，請從插座拔除，若您還繼續插電使用，會有觸電死亡的風險。
- 請勿試圖修理電源變壓器或電源變壓器的纜線，若有毀損，請直接聯絡您購買的店家，購買一個新的電源變壓器。
- 請勿將此設備安裝於室外，此設備僅適合放置於室內。
- 請勿隨一般垃圾丟棄。
- 請參閱產品背貼上的設備額定功率。
- 請參考產品型錄或是彩盒上的作業溫度。
- 產品沒有斷電裝置或者採用電源線的插頭視為斷電裝置的一部分，以下警語將適用：
 - 對永久連接之設備，在設備外部須安裝可觸及之斷電裝置；
 - 對插接式之設備，插座必須接近安裝之地點而且是易於觸及的。

About the Symbols

Various symbols are used in this product to ensure correct usage, to prevent danger to the user and others, and to prevent property damage. The meaning of these symbols are described below. It is important that you read these descriptions thoroughly and fully understand the contents.

Explanation of the Symbols

SYMBOL	EXPLANATION
	Alternating current (AC): AC is an electric current in which the flow of electric charge periodically reverses direction.
	Direct current (DC): DC is the unidirectional flow or movement of electric charge carriers.
	Earth; ground: A wiring terminal intended for connection of a Protective Earthing Conductor.
	Class II equipment: The method of protection against electric shock in the case of class II equipment is either double insulation or reinforced insulation.

Viewing Certifications

Go to <http://www.zyxel.com> to view this product's documentation and certifications.

Zyxel Limited Warranty

Zyxel warrants to the original end user (purchaser) that this product is free from any defects in material or workmanship for a specific period (the Warranty Period) from the date of purchase. The Warranty Period varies by region. Check with your vendor and/or the authorized Zyxel local distributor for details about the Warranty Period of this product. During the warranty period, and upon proof of purchase, should the product have indications of failure due to faulty workmanship and/or materials, Zyxel will, at its discretion, repair or replace the defective products or components without charge for either parts or labor, and to whatever extent it shall deem necessary to restore the product or components to proper operating condition. Any replacement will consist of a new or re-manufactured functionally equivalent product of equal or higher value, and will be solely at the discretion of Zyxel. This warranty shall not apply if the product has been modified, misused, tampered with, damaged by an act of God, or subjected to abnormal working conditions.

Note

Repair or replacement, as provided under this warranty, is the exclusive remedy of the purchaser. This warranty is in lieu of all other warranties, express or implied, including any implied warranty of merchantability or fitness for a particular use or purpose. Zyxel shall in no event be held liable for indirect or consequential damages of any kind to the purchaser.

To obtain the services of this warranty, contact your vendor. You may also refer to the warranty policy for the region in which you bought the device at http://www.zyxel.com/web/support_warranty_info.php.

Registration

Register your product online at www.zyxel.com to receive email notices of firmware upgrades and related information

Open Source Licenses

This product may contain in part some free software distributed under GPL license terms and/or GPL-like licenses.

To request the source code covered under these licenses, please go to: https://www.zyxel.com/form/gpl_oss_software_notice.shtml

Index

Numbers

6rd
IPv6 [108](#)

A

access
troubleshooting [255](#)

Access Control (Rules) screen [201](#)

access point
coverage area [19](#)

activation
firewalls [199](#)
SSID [124](#)

Address Resolution Protocol [219](#)

Any_WAN
Remote Management [231](#)

Application Layer Gateway (ALG) [184](#)

applications
Internet access [16](#)

applications, NAT [190](#)

ARP Table [219](#), [221](#), [226](#)

authentication [136](#)

B

backup
configuration [248](#)

backup configuration [248](#)

Backup/Restore screen [247](#)

Basic Service Set, see BSS

Bridge mode [114](#)

bridge mode [23](#)

bridge mode example [23](#)

broadband [106](#)

Broadband screen

overview [106](#)

broadcast [116](#)

BSS [138](#)
example [139](#)

button
reset [27](#)

C

Canonical Format Indicator See CFI

certifications [278](#)
viewing [281](#)

CFI [116](#)

client list [150](#)

configuration
backup [248](#)
firewalls [199](#)
restoring [249](#)
static route [195](#)

contact information [261](#)

controller
network [18](#)

copyright [276](#)

coverage area
access point [19](#)
repeater [19](#)

CTS threshold [131](#), [136](#)

customer support [261](#)

customized service [200](#)
add [201](#)

customized services [201](#)

D

daisy chain
form [21](#)

data fragment threshold [131](#), [136](#)

DDoS [198](#)

Denials of Service, see DoS
DHCP [145, 157](#)
DHCP Server Lease Time [148](#)
DHCP Server State [148](#)
diagnostic [251](#)
diagnostic screens [251](#)
disclaimer [276](#)
DMZ screen [183](#)
DNS [145, 157](#)
DNS server address assignment [116](#)
DNS Values [148](#)
Domain Name [191](#)
domain name system, see DNS
DoS [198](#)
 thresholds [198](#)
DoS protection blocking
 enable [204](#)
Dual Stack Lite [108](#)
dual-band application [17, 20](#)
dual-band gateway [16](#)
dual-band WiFi [19](#)
dynamic DNS [193](#)
 wildcard [194](#)
Dynamic Host Configuration Protocol, see DHCP
DYNDNS wildcard [194](#)

E

ECHO [191](#)
email
 log example [242](#)
 log setting [242](#)
Encapsulation [115](#)
encapsulation method
 technical reference [115](#)
Ethernet port [27](#)
Extended Service Set IDentification [121, 125](#)

F

factory defaults
 reset [249](#)

factory-default configuration
 reload [28](#)
filters
 MAC address [127, 137](#)
Finger services [191](#)
firewall
 enhancing security [206](#)
 LAND attack [198](#)
 security considerations [206](#)
 traffic rule direction [204](#)
Firewall DoS screen [204](#)
Firewall General screen [199](#)
firewall rules
 direction of travel [205](#)
firewalls [197, 199](#)
 actions [204](#)
 configuration [199](#)
 customized service [200](#)
 customized services [201](#)
 DDoS [198](#)
 DoS [198](#)
 thresholds [198](#)
 ICMP [198](#)
 Ping of Death [198](#)
 rules [205](#)
 security [206](#)
 SYN attack [197](#)
firmware
 version [96](#)
Firmware Upgrade screen [244, 246](#)
firmware upload [244, 246](#)
firmware version
 check [244, 246](#)
fragmentation threshold [131, 136](#)
FTP [24, 177, 191](#)
 unusable [257](#)

G

General wireless LAN screen [119](#)
guest WiFi [17](#)

H

HTTP [191](#)

I

ICMP [198](#)

IEEE 802.11a/b/g/n/ac/ax [19](#)

IEEE 802.11ax [119](#)

IEEE 802.1Q [116](#)

IGA [189](#)

IGMP [116](#)

version [116](#)

ILA [189](#)

Inside Global Address, see IGA

Inside Local Address, see ILA

Internet

no access [258](#)

wizard setup [40](#)

Internet access

wizard setup [40](#)

Internet access application

Ethernet WAN [16](#)

Internet Blocking [94](#)

Internet connection

add or edit [110](#)

slow or erratic [258](#)

Internet Control Message Protocol, see ICMP

Internet Protocol version 6 [107](#)

Internet Protocol version 6, see IPv6

IP address [158](#)

private [158](#)

WAN [107](#)

IP address assignment [115](#)

IP alias

NAT applications [191](#)

IP packet

transmission method [116](#)

IPv4 firewall [200](#)

IPv6 [107, 266](#)

addressing [107, 117, 266](#)

EUI-64 [268](#)

global address [266](#)

interface ID [268](#)

link-local address [266](#)

Neighbor Discovery Protocol [266](#)

ping [266](#)

prefix [107, 117, 266](#)

prefix and length [107](#)

prefix delegation [109](#)

prefix length [107, 117, 266](#)

subnet mask [107](#)

unspecified address [267](#)

IPv6 address

abbreviation method [117](#)

IPv6 firewall [200](#)

IPv6 rapid deployment [108](#)

L

LAN [144](#)

client list [150](#)

DHCP [157](#)

DNS [157](#)

IP address [158](#)

MAC address [151](#)

status [97, 102](#)

subnet mask [146, 158](#)

LAN IP address [148](#)

LAN IPv6 Mode Setup [149](#)

LAN Setup screen [146](#)

LAN subnet mask [148](#)

LAND attack [198](#)

limitations

wireless LAN [138](#)

WPS [143](#)

Local Area Network, see LAN

Log Setting screen [240](#)

login [31](#)

password [31](#)

Login screen

no access [255](#)

logs [212, 215, 240](#)

M

MAC address [128, 151](#)

filter [127, 137](#)

- LAN [151](#)
- MAC Authentication screen [127](#)
- MAC Filter [208](#)
- managing the device
 - good habits [24](#)
- MBSSID [139](#)
- Mesh application [19](#)
- MGMT Services screen [230](#)
- module firmware [245](#)
- MTU (Multi-Tenant Unit) [115](#)
- Multi_WAN
 - Remote Management [231](#)
- multicast [116](#)
- multi-gigabit [16](#)
- Multiple BSS, see MBSSID

N

- NAT [189](#)
 - applications [190](#)
 - IP alias [191](#)
 - default server [183](#)
 - DMZ host [183](#)
 - example [190](#)
 - global [189](#)
 - IGA [189](#)
 - ILA [189](#)
 - inside [189](#)
 - local [189](#)
 - multiple server example [177](#)
 - outside [189](#)
 - port number [191](#)
 - services [191](#)
- NAT ALG screen [184, 185, 188](#)
- NAT example [192](#)
- Network Address Translation, see NAT
- network disconnect
 - temporary [245](#)
- network map [94](#)
- NNTP [191](#)
- Nslookup test [252](#)

O

- Others screen [130](#)

P

- password [31](#)
 - admin [255](#)
 - lost [255](#)
 - user [255](#)
- PBC [140](#)
- Ping of Death [198](#)
- Ping test [252](#)
- Ping/TraceRoute/Nslookup screen [251](#)
- Point-to-Point Tunneling Protocol, see PPTP
- POP3 [191](#)
- port
 - LAN [27](#)
 - WAN [27](#)
- port forwarding rule
 - add/edit [178](#)
- Port Forwarding screen [178](#)
- Port Triggering
 - add new rule [182](#)
- Port Triggering screen [180](#)
- POWER button [27](#)
- PPTP [191](#)
 - preamble [132, 136](#)
 - preamble mode [139](#)
 - prefix delegation [109](#)
 - private IP address [158](#)
 - problems [254](#)
- Protocol (Customized Services) screen [200](#)
- Protocol Entry
 - add [201](#)
- Push Button Configuration, see PBC
- push button, WPS [140](#)

R

- Reboot screen [250](#)
- reset [28](#)

RESET button [27](#)
reset to factory defaults [249](#)
restart system [250](#)
restoring configuration [249](#)
RFC 1631 [176](#)
RFC 3164 [212](#)
router controller [19](#)
RTS threshold [131, 136](#)

S

security
 network [206](#)
 wireless LAN [136](#)
Security Log [214](#)
Security Parameter Index, see SPI
service access control [232](#)
Service Set [121, 125](#)
services
 port forwarding [191](#)
setup
 firewalls [199](#)
 static route [195](#)
SMTP [191](#)
SPI [198](#)
SSH
 unusable [257](#)
SSID [137](#)
 activation [124](#)
 MBSSID [139](#)
standard (router) mode [22](#)
standard mode example [23](#)
static DHCP [150](#)
 configuration [152](#)
Static DHCP screen [150](#)
static route [167](#)
 configuration [195](#)
status [94](#)
 firmware version [96](#)
 LAN [97, 102](#)
 WAN [97](#)
 wireless LAN [97](#)
subnet mask [158](#)
SYN attack [197](#)

syslog
 protocol [212](#)
 severity levels [212](#)
syslog logging
 enable [241](#)
syslog server
 name or IP address [241](#)
system
 firmware
 version [96](#)
 module firmware [245](#)
 password [31](#)
 reset [28](#)
 status [94](#)
 LAN [97, 102](#)
 WAN [97](#)
 wireless LAN [97](#)
 time [234](#)

T

Telnet
 unusable [257](#)
thresholds
 data fragment [131, 136](#)
 DoS [198](#)
 RTS/CTS [131, 136](#)
time [234](#)
top panel
 LED indicators [25](#)
TPID [116](#)
Trace Route test [252](#)
troubleshooting [254](#)
Trust Domain
 add [232](#)
Trust Domain screen [232](#)
TWT (Target Wakeup Time) [119](#)

U

unicast [116](#)
Universal Plug and Play, see UPnP
upgrading module firmware [245](#)
uplink connection

- WiFi [21](#)
- wired [21](#)
- UPnP [152](#)
 - forum [146](#)
 - NAT traversal [145](#)
 - security issues [146](#)
 - state [153](#)
 - usage confirmation [145](#)
- UPnP screen [152](#)
- UPnP-enabled Network Device
 - auto-discover [161](#)

V

- Virtual Local Area Network See VLAN
- VLAN [115](#)
 - Introduction [115](#)
- VLAN ID [116](#)
- VLAN tag [116](#)

W

- Wake on LAN [155](#)
- WAN
 - status [97](#)
 - Wide Area Network, see WAN [106](#)
- WAN IP address [107](#)
- warranty [281](#)
 - note [281](#)
- Web Configurator
 - login [31](#)
 - password [31](#)
- WEP [122](#)
- WEP Encryption [123](#)
- WiFi
 - MBSSID [139](#)
- WiFi standards
 - comparison table [119](#)
- WiFi6 introduction [119](#)
- Wireless General screen [119](#)
- wireless LAN [118](#)
 - authentication [136](#)
 - BSS [138](#)

- example [139](#)
- example [135](#)
- fragmentation threshold [131, 136](#)
- limitations [138](#)
- MAC address filter [127, 137](#)
- preamble [132, 136](#)
- RTS/CTS threshold [131, 136](#)
- security [136](#)
- SSID [137](#)
 - activation [124](#)
- status [97](#)
- WPS [140](#)
 - example [142](#)
 - limitations [143](#)
 - push button [140](#)
- Wireless tutorial [50](#)
- wizard setup
 - Internet [40](#)
- WMM screen [130](#)
- WPA [122](#)
- WPA2 [122](#)
- WPA2-PSK [122](#)
- WPA3-SAE (Simultaneous Authentication of Equals handshake) [122](#)
- WPA-PSK (WiFi Protected Access-Pre-Shared Key) [122](#)
- WPS [140](#)
 - activate [28](#)
 - example [142](#)
 - limitations [143](#)
 - push button [140](#)
- WPS button [27](#)
 - using [28](#)
- WPS screen [128](#)

Z

- Zyxel Device
 - managing [23](#)